



IGS-9822DGP+

Industrial Managed Ethernet Switch

User Manual

Version 1.0

Mar, 2018

Table of Content

Getting Started	5
1.1 About the IGS-9822DGP+	5
1.2 Software Features	5
1.3 Hardware Specifications	6
Hardware Overview.....	7
2.1 Installing Switch on DIN-Rail.....	7
2.1.1 Mount IGS-9822DGP+ on DIN-Rail.....	7
Hardware Overview.....	9
3.1 Front Panel	9
3.2 Front Panel LEDs	10
3.3 Top view Panel	11
Hardware Installation.....	12
4.1 Wiring.....	12
4.1.1 Fault Relay.....	12
4.1.2 Redundant Power Inputs	12
4.2 Connection.....	13
4.2.1 Cables	13
1000/100BASE-TX/10BASE-T Pin Assignments	13
RS-232 console port wiring	14
4.2.2 SFP	15
4.2.3 O-Ring	16
O-Ring	16
Redundancy	18
5.1 O-Ring	18
5.1.1 Introduction	18
5.1.2 Configurations	18
5.2 MSTP.....	19
5.2.1 STP Configurations	19
5.2.2 MSTI Mapping.....	21
Priority.....	22
5.2.3 CIST.....	23
Port Settings	23

5.2.4	MSTI Ports	24
5.2.5	Bridge Status	25
5.2.6	Port Status	28
5.2.7	Port Statistics	29
Management.....		30
6.1	Basic Settings.....	32
6.1.1	System Information	32
6.1.2	Auth Method	33
6.1.3	Users	34
6.1.4	IP Settings	37
6.1.5	IP Status	39
6.1.6	Daylight Saving Time.....	40
6.1.7	HTTPS.....	42
6.1.8	SSH	43
6.1.9	DBU01 Option Config	43
6.1.10	LLDP	44
6.1.11	NTP	48
6.1.12	Upnp.....	49
6.1.13	ModbusTCP	50
6.1.14	Ethernet/IP	50
6.1.15	Backup/Restore Configurations	51
6.1.16	Firmware Update.....	51
6.2	DHCP.....	52
6.2.1	DHCP Server	52
6.2.2	DHCP Relay	56
6.2.3	DHCP Snooping	58
6.3	Port Setting	61
6.3.1	Port Control.....	61
6.3.2	Port Trunk	64
6.3.3	Loop Protection	69
6.4	VLAN	71
6.4.1	VLAN Membership	71
6.4.2	Membership Status	76
6.4.3	Port Status	77
6.4.4	Private VLAN	78
6.4.5	GVRP.....	80
6.5	SNMP	82

6.5.1	SNMP System Configurations	82
6.5.2	Trap.....	83
6.5.3	SNMP Community Configurations.....	85
6.5.4	SNMP User Configurations	86
6.5.5	SNMP Group Configurations	87
6.5.6	SNMP View Configurations	88
6.5.7	SNMP Access Configurations.....	89
6.5.8	RMON.....	90
6.6	Traffic Prioritization.....	96
6.6.1	Storm Control.....	96
6.6.2	Port Classification	97
6.6.3	Port Tag Remaking	99
6.6.4	Port DSCP	100
6.6.5	Port Policing.....	101
6.6.6	Queue Policing	102
5.6.7	QoS Egress Port Scheduler and Shapers.....	102
5.6.8	Port Scheduler	105
5.6.9	Port Shaping.....	105
5.6.10	DSCP-Based QoS.....	106
5.6.11	DSCP Translation.....	107
5.6.12	DSCP Classification	108
5.6.13	QoS Control List.....	108
5.6.14	QoS Counters.....	110
5.6.15	QCL Status	111
5.6.16	WRED	112
6.7	Multicast	115
5.7.1	IGMP Snooping	115
6.8	Security	120
6.8.1	Device Binding.....	120
6.8.2	Access Management	125
6.8.3	IP Source Guard	126
6.8.4	ACL.....	128
6.8.5	AAA.....	140
6.8.6	TACACS+	141
6.8.8	NAS (802.1x)	144
6.8.9	ARP Inspection	155
6.8.10	Port Security.....	157

6.9	Warning	161
6.9.1	Fault Alarm.....	161
6.9.2	System Warning	161
6.10	Monitor and Diag	163
6.10.1	MAC Table	163
6.10.2	Port Statistics.....	167
6.10.3	Port Monitoring	169
6.10.4	System Log Information	170
6.10.5	Cable Diagnostics	172
6.10.6	SFP Monitor	173
6.10.7	SFP Type.....	173
6.10.8	Ping	173
	IPv6 Ping	174
6.11	Configuration	175
6.11.1	Activate.....	175
6.11.2	Delete	175
6.12	Save	175
6.13	Troubleshooting.....	176
6.13.1	Factory Defaults	176
6.13.2	System Reboot.....	176

Getting Started

1.1 About the IGS-9822DGP+

IGS-9822DGP+ is managed redundant ring Gigabit Ethernet switch with 8x10/100/1000Base-T(X) ports and 2x 100/1G/2.5GBase-X + 2x 1G/10GBase-X SFP ports. The switch support Ethernet Redundancy protocol, Redundant-Ring (recovery time < 30ms), and MSTP (RSTP/STP compatible) can protect your mission-critical applications from network interruptions or temporary malfunctions with its fast recovery technology. And support wide operating temperature from -40 oC to 75 oC. IGS-9822DGP+ can also be managed centralized and convenient by Open-Vision, Except the Web-based interface, Telnet and console (CLI) configuration. Therefore, the switch is one of the most reliable choice for highly-managed and Fiber Ethernet application.

1.2 Software Features

- Supports Redundant-Ring (recovery time < 30ms), and MSTP(RSTP/STP compatible) for Ethernet Redundancy
- Supports IEEE 802.3az Energy-Efficient Ethernet technology
- Supports IPV6 new Internet protocol version
- Supports HTTPS/SSH protocols for high network security
- Supports IP-based bandwidth management
- Supports application-based QoS management
- IGMP v2/v3 (IGMP snooping) support for filtering multicast traffic
- Supports SNMP v1/v2c/v3 & RMON & 802.1Q VLAN network management
- Supports ACL and 802.1x user authentication
- Supports 9.6K bytes Jumbo frame
- Multiple notifications during unexpected events
- Configuration via Web-based ,Telnet, Console (CLI), and Windows utility (Open-Vision)
- Supports LLDP Protocol
- Support DBU-01 backup unit device to quickly backup/restore configuration

1.3 Hardware Specifications

- Redundant 12~48VDC power inputs
- 8 x 10/100/1000Base-T(X) ports
- 2x 1G/10GBase-X SFP+ sockets
- 2x 100/1G/2.5GBase-X SFP+ sockets
- 1 x console port
- Operating temperature: -20 to 60 °C at 10G, -40 to 75°C at Full Gigabit
- Storage temperature: -40 to 85°C
- Operating humidity: 5% to 95%, non-condensing
- Casing: IP-30
- DIN-Rail and wall mounting enabled
- Dimensions: 74.3 (W) x 125 (D) x 153.6 (H)mm

Hardware Overview

2.1 Installing Switch on DIN-Rail

Each switch has a DIN-Rail kit on rear panel. The DIN-Rail kit helps switch to fix on the DIN-Rail. It is easy to install the switch on the DIN-Rail:

2.1.1 Mount IGS-9822DGP+ on DIN-Rail

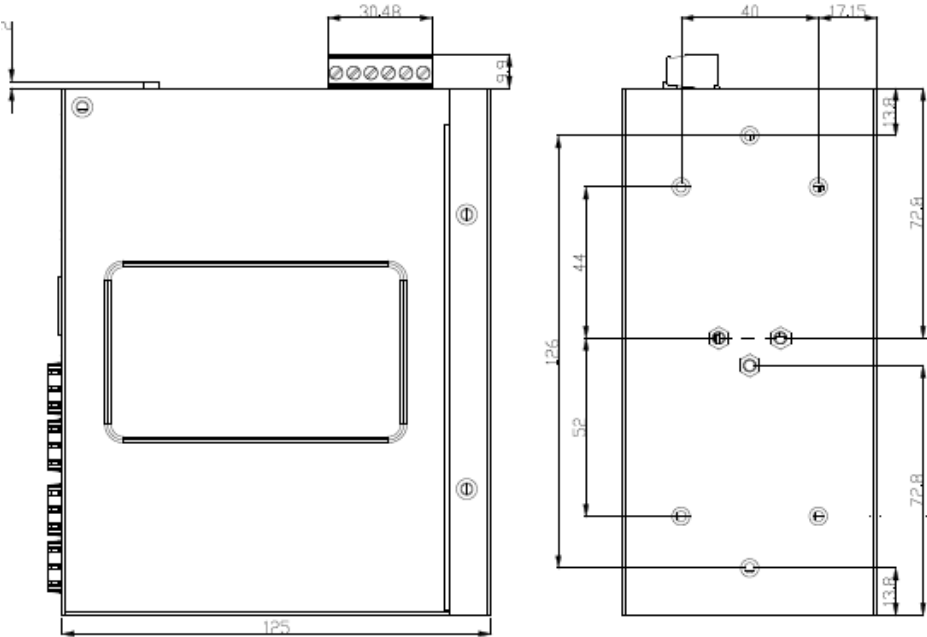

DIN-Rail Size

Wall Mounting Installation

Each switch has another installation method for users to fix the switch. A wall mount panel can be found in the package. The following steps show how to mount the switch on the wall:

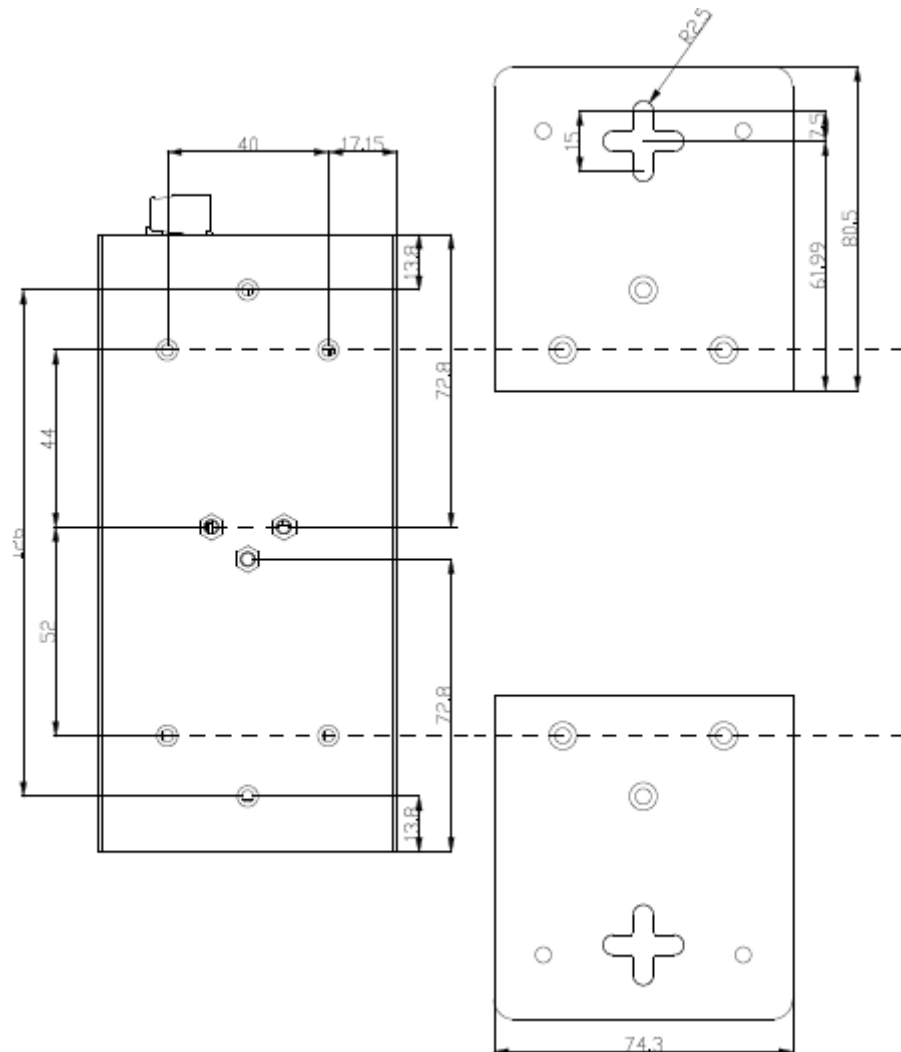

Wall-Mounting size

Hardware Overview

3.1 Front Panel

The following table describes the labels that stick on the IGS-9822DGP+.

Port	Description
SFP Port	2 x 100 / 1G / 2.5G
SFP+ Port	2.x 1G / 10G
Copper Port	8 x 10/100/1000Base-T(X)
Console	Use RS-232 with RJ-45 connector to manage switch.

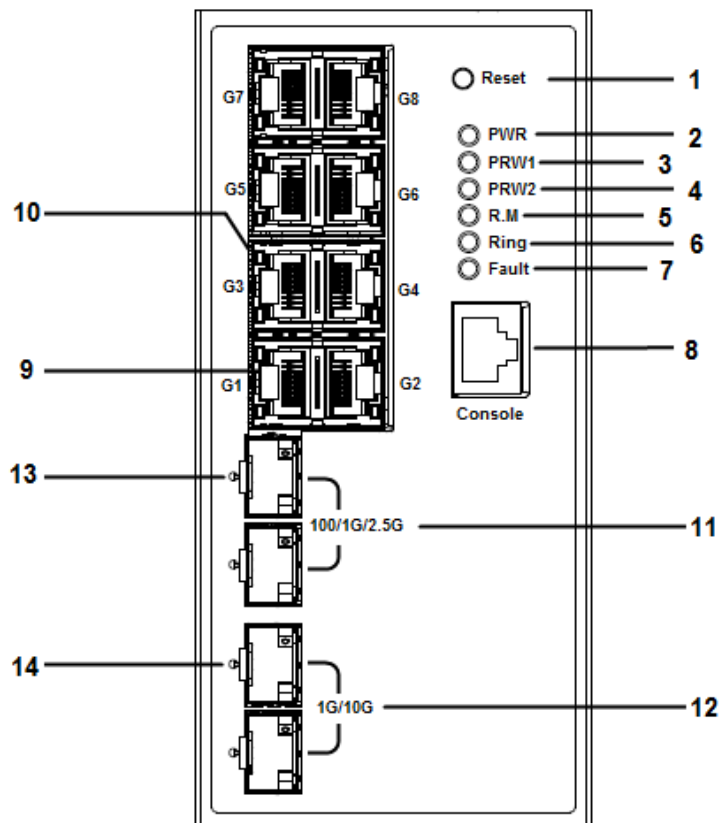

1. Reset button. Push the button 3 seconds for reset; 5 seconds for factory default.
2. LED for PWR. When the PWR UP, the green led will be light on
3. LED for PWR1
4. LED for PWR2
5. LED for R.M (Ring master). When the LED light on, it means that the switch is the ring master of Ring. · LED for Ring. When the led light on, it means the Ring is activated.

6. LED for Ring. When the led light on, it means the Redundant-Ring is activated.
7. LED for Fault. When the light on, it means Power failure or Port down/fail.
8. Console port (RJ-45)
9. 10/100/1000Base-T(X) ports
10. LED for Ethernet ports link/act/speed status (right port indicator)
11. SFP Port support 100 / 1G / 2.5G
12. SFP+ Port support 1G / 10G
13. 10/100/1000Base-T(X) ports
14. LED for SFP Ports
15. LED for SFP+ Ports

3.2 Front Panel LEDs

LED	Color	Status	Description
PWR	Green	On	DC power module up
PW1	Green	On	DC power module 1activated.
PW2	Green	On	DC Power module 2activated.
R.M	Green	On	Ring Master.
Ring	Green	On	Ring enabled.
		Slowly blinking	Ring has only One link. (lack of one link to build the ring.)
		Fast blinking	Ring work normally.
Fault	Amber	On	Fault relay. Power failure or Port down/fail.
Gigabit Ethernet ports			
ACT/LNK	Green	On	Port link up
		Blinking	Data transmitted
SPEED	Green/Amber	Green	Port link up on 1000Mbps
		Amber	Port link up on 100Mbps
		OFF	Port link up on 10Mbps
SFP ports			
LNK/LNK	Green	On	Port link up.
		Blinking	Data transmitted.

3.3 Top view Panel

The bottom panel components of IGS-9822DGP+ are showed as below:

- 1. Terminal block includes: PWR1, PWR2 (12-48V DC)
- 2. Ground wire

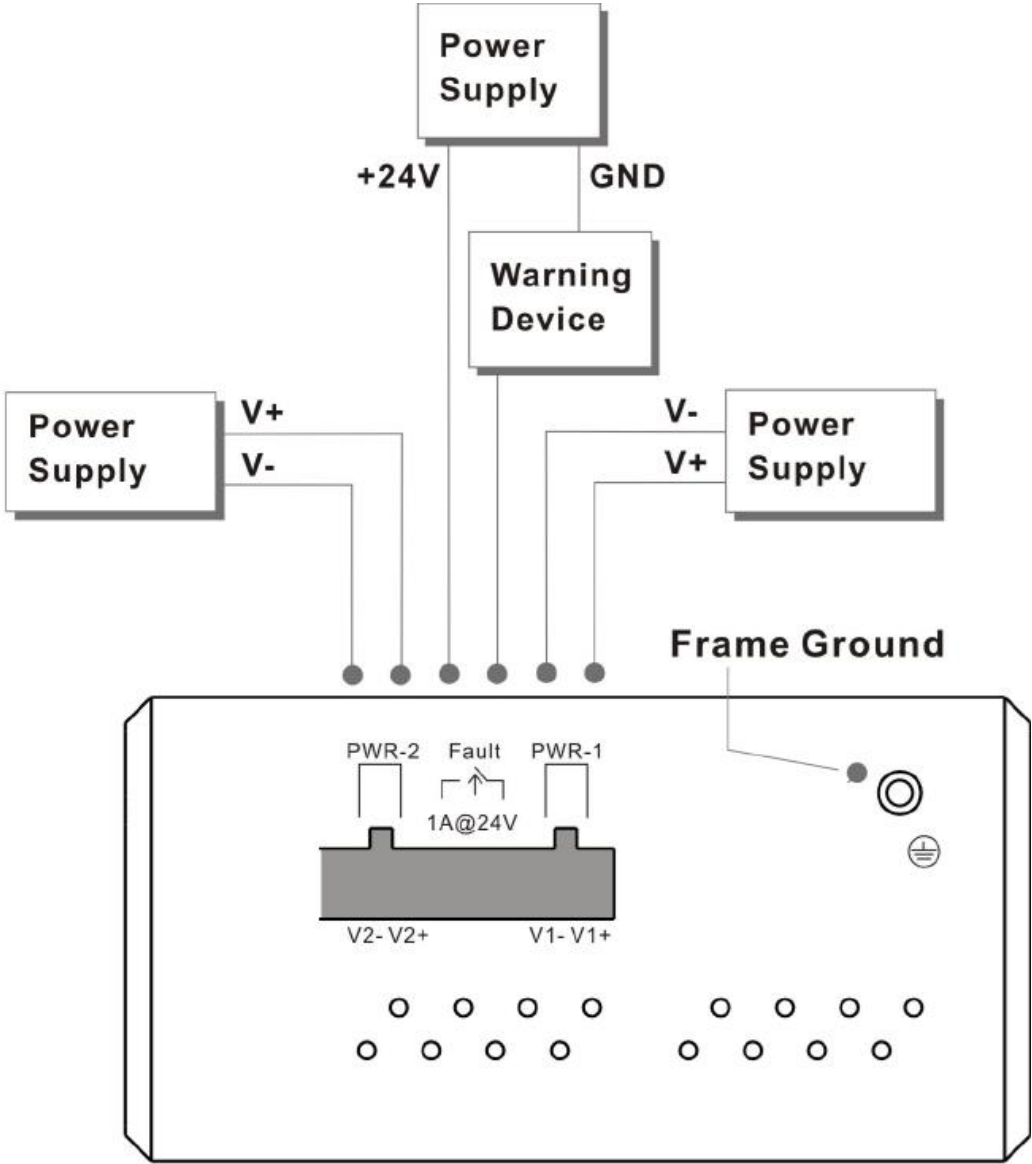

Hardware Installation

4.1 Wiring



ATTENTION

1. Be sure to disconnect the power cord before installing and/or wiring your switches.
 2. Calculate the maximum possible current in each power wire and common wire. Observe all electrical codes dictating the maximum current allowable for each wire size.
 3. If the current goes above the maximum ratings, the wiring could overheat, causing serious damage to your equipment.
 4. Use separate paths to route wiring for power and devices. If power wiring and device wiring paths must cross, make sure the wires are perpendicular at the intersection point.
 5. Do not run signal or communications wiring and power wiring through the same wire conduit. To avoid interference, wires with different signal characteristics should be routed separately.
 6. You can use the type of signal transmitted through a wire to determine which wires should be kept separate. The rule of thumb is that wiring sharing similar electrical characteristics can be bundled together
 7. You should separate input wiring from output wiring
 8. It is advised to label the wiring to all devices in the system
-

4.1.1 Fault Relay

The three-pin fault relay terminal on the front panel is used to detect user-configured events. The two wires attached to the fault contacts form an open circuit when a user-configured when an event is triggered. If a user-configured event does not occur, the fault circuit remains closed.

4.1.2 Redundant Power Inputs

The switch has two sets of power inputs, power input 1 and power input 2. Follow the steps below to wire redundant power inputs.

Step 1: insert the negative/positive wires into the V-/V+ terminals, respectively.

Step 2: to keep the DC wires from pulling loose, use a small flat-blade screwdriver to tighten the wire-clamp screws on the front of the terminal block connector.

4.2 Connection

4.2.1 Cables

1000/100BASE-TX/10BASE-T Pin Assignments

The device has standard Ethernet ports. According to the link type, the switch uses CAT 3, 4, 5, 5e UTP cables to connect to any other network devices (PCs, servers, switches, routers, or hubs). Please refer to the following table for cable specifications.

Cable Types and Specifications:

Cable	Type	Max. Length	Connector
10BASE-T	Cat. 3, 4, 5 100-ohm	UTP 100 m (328 ft)	RJ-45
100BASE-TX	Cat. 5 100-ohm UTP	UTP 100 m (328 ft)	RJ-45
1000BASE-T	Cat. 5/Cat. 5e 100-ohm UTP	UTP 100 m (328ft)	RJ-45

With 10/100/1000Base-T(X) cables, pins 1 and 2 are used for transmitting data, and pins 3 and 6 are used for receiving data.

10/100Base-T(X) RJ-45 Port Pin Assignments:

Pin Number	Assignment
1	TD+
2	TD-
3	RD+
6	RD-

1000Base-T RJ-45 Port Pin Assignments:

Pin Number	Assignment
1	BI_DA+
2	BI_DA-
3	BI_DB+
4	BI_DC+
5	BI_DC-
6	BI_DB-
7	BI_DD+
8	BI_DD-

The device supports auto MDI/MDI-X operation. You can use a cable to connect the switch to a PC. The table below shows the 10/100Base-T(X) MDI and MDI-X port pin outs.

10/100Base-T(X) MDI/MDI-X Pin Assignments:

Pin Number	MDI port	MDI-X port
1	TD+(transmit)	RD+(receive)
2	TD-(transmit)	RD-(receive)
3	RD+(receive)	TD+(transmit)
4	Not used	Not used
5	Not used	Not used
6	RD-(receive)	TD-(transmit)
7	Not used	Not used
8	Not used	Not used

1000Base-T MDI/MDI-X Pin Assignments:

Pin Number	MDI port	MDI-X port
1	BI_DA+	BI_DB+
2	BI_DA-	BI_DB-
3	BI_DB+	BI_DA+
4	BI_DC+	BI_DD+
5	BI_DC-	BI_DD-
6	BI_DB-	BI_DA-
7	BI_DD+	BI_DC+
8	BI_DD-	BI_DC-

Note: "+" and "-" signs represent the polarity of the wires that make up each wire pair.

RS-232 console port wiring

The device can be managed via console ports using a RS-232 cable which can be found in the package. You can connect the port to a PC via the RS-232 cable with a DB-9 female connector. The DB-9 female connector of the RS-232 cable should be connected the PC while the other end of the cable (RJ-45 connector) should be connected to the console port of the switch.

PC pin out (male) assignment	RS-232 with DB9 female connector	DB9 to RJ 45
Pin #2 RD	Pin #2 TD	Pin #2
Pin #3 TD	Pin #3 RD	Pin #3

Pin #5 GD	Pin #5 GD	Pin #5
-----------	-----------	--------

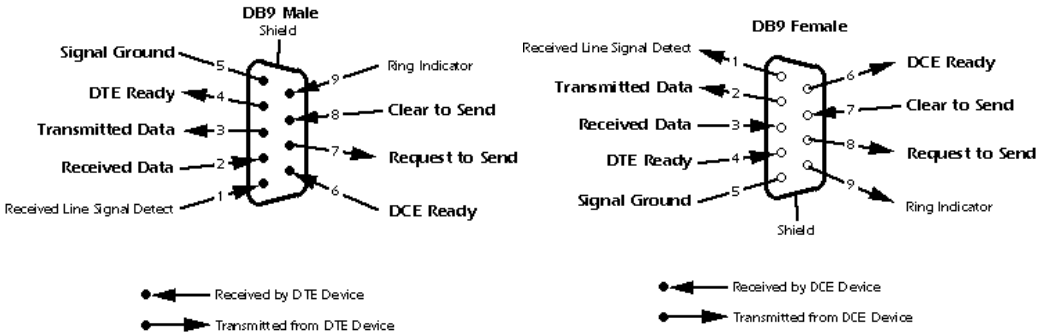

4.2.2 SFP

The switch comes with fiber optical ports that can connect to other devices using SFP modules. The fiber optical ports are in multi-mode and single-mode with LC connectors. Please remember that the TX port of Switch A should be connected to the RX port of Switch B.

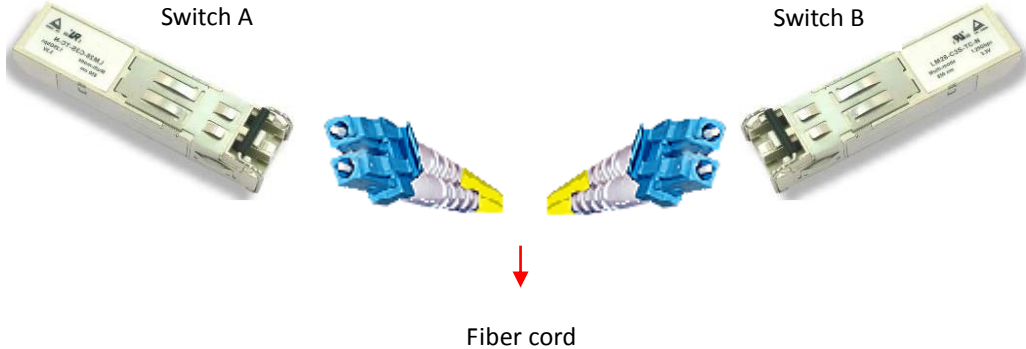

4.2.3 O-Ring

O-Ring

You can connect three or more switches to form a ring topology to gain network redundancy capabilities through the following steps.

1. Connect each switch to form a daisy chain using an Ethernet cable.
2. Set one of the connected switches to be the master and make sure the port setting of each connected switch on the management page corresponds to the physical ports connected. For information about the port setting, please refer to [5.1.2 Configurations](#).
3. Connect the last switch to the first switch to form a ring topology.

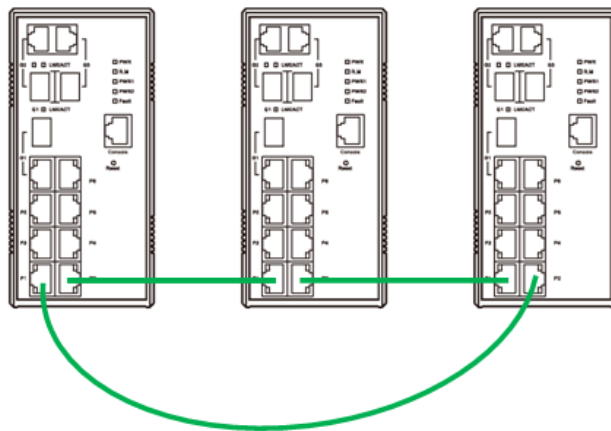

Coupling Ring

If you already have two Redundant-Ring topologies and would like to connect the rings, you can form them into a coupling ring. All you need to do is select two switches from each ring to be connected, for example, switch A and B from Ring 1 and switch C and D from ring 2. Decide which port on each switch to be used as the coupling port and then link them together, for example, port 1 of switch A to port 2 of switch C and port 1 of switch B to port 2 of switch D. Then, enable Coupling Ring option by checking the checkbox on the management page and select the coupling ring in correspondence to the connected port. For more information on port setting, please refer to [5.1.2 Configurations](#). Once the setting is completed, one of the connections will act as the main path while the other will act as the backup path.

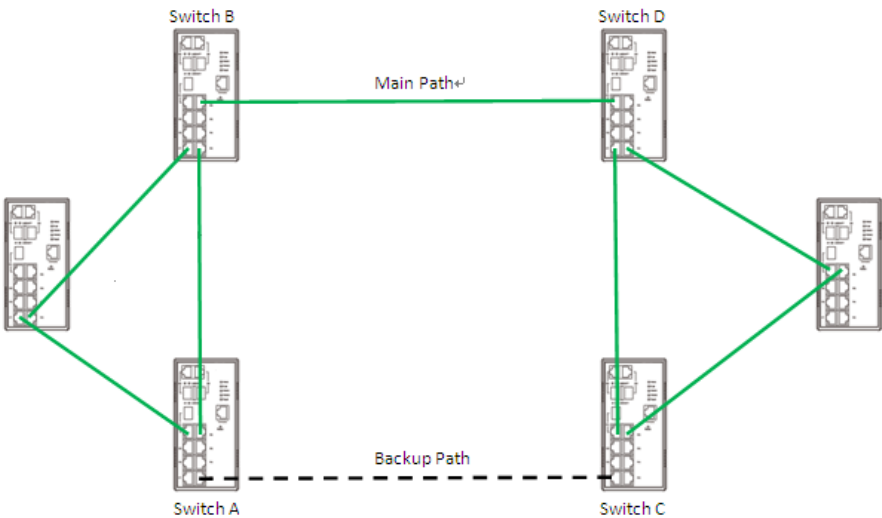

Dual Homing

If you want to connect your ring topology to a RSTP network environment, you can use dual homing. Choose two switches (Switch A & B) from the ring for connecting to the switches in the RSTP network (core switches). The connection of one of the switches (Switch A or B) will act as the primary path, while the other will act as the backup path that is activated when the primary path connection fails.

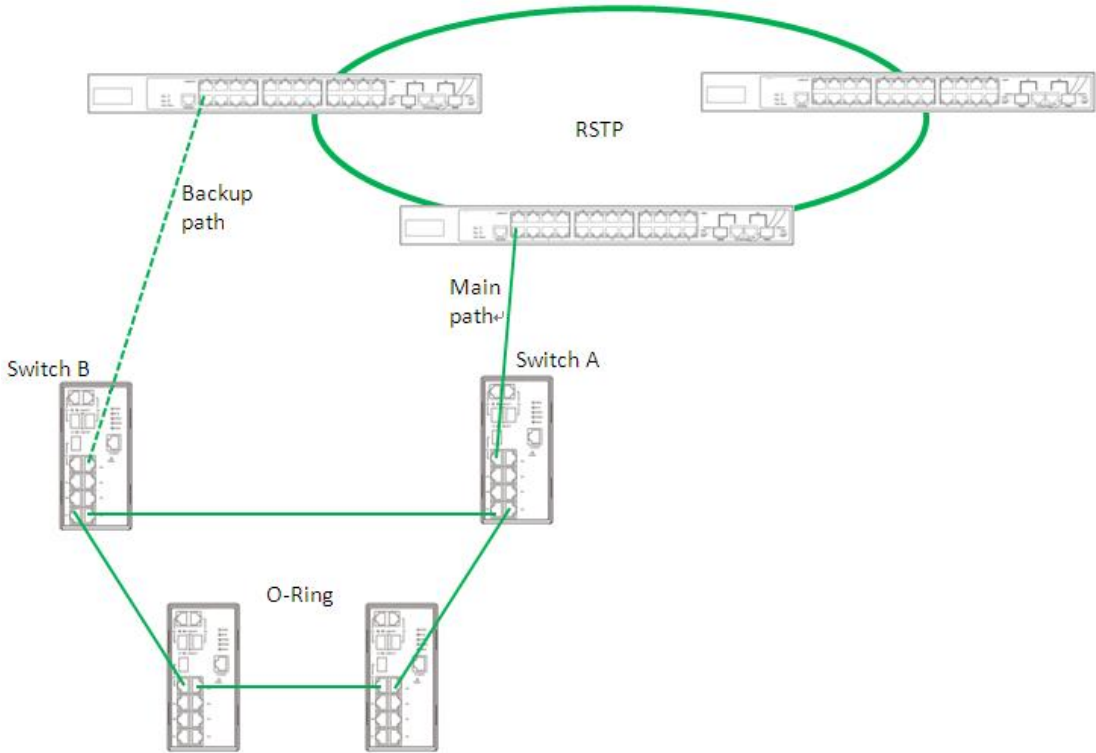

Redundancy

Redundancy for minimized system downtime is one of the most important concerns for industrial networking devices. Hence, we have developed proprietary redundancy technologies including Redundant-Ring, featuring faster recovery time than existing redundancy technologies widely used in commercial applications, such as STP, RSTP, and MSTP. We proprietary redundancy technologies not only support different networking topologies, but also assure the reliability of the network.

5.1 O-Ring

5.1.1 Introduction

O-Ring recovery time of less than 10 milliseconds and up to 250 nodes. The ring protocols identify one switch as the master of the network, and then automatically block packets from traveling through any of the network's redundant loops. In the event that one branch of the ring gets disconnected from the rest of the network, the protocol automatically readjusts the ring so that the part of the network that was disconnected can reestablish contact with the rest of the network. The redundant ring technology can protect mission-critical applications from network interruptions or temporary malfunction with its fast recover technology.

5.1.2 Configurations

Redundant-Ring supports two ring topologies: **Coupling Ring**, and **Dual Homing**. You can configure the settings in the interface below.

O-Ring Configuration

<input type="checkbox"/> O-Ring		
Ring Master	Disable ▾	This switch is Not a Ring Master.
1st Ring Port	Port 1 ▾	LinkDown
2nd Ring Port	Port 2 ▾	LinkDown
<input type="checkbox"/> Coupling Ring		
Coupling Port	Port 3 ▾	LinkDown
<input type="checkbox"/> Dual Homing		
Homing Port	Port 4 ▾	Inactive

Label	Description
O-Ring	Check to enable O-Ring topology.
Ring Master	Only one ring master is allowed in a ring. However, if more than one switch are set to enable Ring Master , the switch with the lowest MAC address will be the active ring master and the others will be backup masters.
1st Ring Port	The primary port when the switch is ring master
2nd Ring Port	The backup port when the switch is ring master
Coupling Ring	Check to enable Coupling Ring . Coupling Ring can divide a big ring into two smaller rings to avoid network topology changes affecting all switches. It is a good method for connecting two rings.
Coupling Port	Ports for connecting multiple rings. A coupling ring needs four switches to build an active and a backup link. Links formed by the coupling ports will run in active/backup mode.
Dual Homing	Check to enable Dual Homing . When Dual Homing is enabled, the ring will be connected to normal switches through two RSTP links (ex: backbone Switch). The two links work in active/backup mode, and connect each ring to the normal switches in RSTP mode.
Apply	Click to apply the configurations.

Note: due to heavy loading, setting one switch as ring master and coupling ring at the same time is not recommended.

5.2 MSTP

5.2.1 STP Configurations

STP (Spanning Tree Protocol), and its advanced versions RSTP (Rapid Spanning Tree Protocol) and MSTP (Multiple Spanning Tree Protocol), are designed to prevent network loops and provide network redundancy. Network loops occur frequently in large networks as when two or more paths run to the same destination, broadcast packets may get in to an infinite loop and hence causing congestion in the network. STP can identify the best path to the destination, and block all other paths. The blocked links will stay connected but inactive. When the best path fails, the blocked links will be activated. Compared to STP which recovers a link in 30 to 50 seconds, RSTP can shorten the time to 5 to 6 seconds.

Basic Settings	
Protocol Version	STP ▼
Bridge Priority	128 ▼
Hello Time	2
Forward Delay	15
Max Age	20
Maximum Hop Count	20
Transmit Hold Count	6

Advanced Settings	
Edge Port BPDU Filtering	<input type="checkbox"/>
Edge Port BPDU Guard	<input type="checkbox"/>
Port Error Recovery	<input type="checkbox"/>
Port Error Recovery Timeout	

Label	Description
Protocol Version	The version of the STP protocol. Valid values include STP, RSTP and MSTP.
Forward Delay	The delay used by STP bridges to transit root and designated ports to forwarding (used in STP compatible mode). The range of valid values is 4 to 30 seconds.
Max Age	The maximum time the information transmitted by the root bridge is considered valid. The range of valid values is 6 to 40 seconds, and Max Age must be $\leq (\text{FwdDelay}-1)*2$.
Maximum Hop Count	This defines the initial value of remaining Hops for MSTI information generated at the boundary of an MSTI region. It defines how many bridges a root bridge can distribute its BPDU information to. Valid values are in the range 6 to 40 hops.
Transmit Hold Count	The number of BPDUs a bridge port can send per second. When exceeded, transmission of the next BPDU will be delayed. The range of valid values is 1 to 10 BPDUs per second.
Edge Port BPDU Filtering	Control whether a port explicitly configured as Edge will transmit and receive BPDUs.
Edge Port BPDU Guard	Control whether a port explicitly configured as Edge will disable itself upon reception of a BPDU. The port will enter the error-disabled state, and will be removed from the active topology.

Port Error Recovery	Control whether a port in the error-disabled state automatically will be enabled after a certain time. If recovery is not enabled, ports have to be disabled and re-enabled for normal STP operation. The condition is also cleared by a system reboot.
Port Error Recovery Timeout	The time to pass before a port in the error-disabled state can be enabled. Valid values are between 30 and 86400 seconds (24 hours).

5.2.2 MSTI Mapping

Since the recovery time of STP and RSTP takes seconds, which are unacceptable in some industrial applications, MSTP was developed. The technology supports multiple spanning trees within a network by grouping and mapping multiple VLANs into different spanning-tree instances, known as MSTIs, to form individual MST regions. Each switch is assigned to an MST region. Hence, each MST region consists of one or more MSTP switches with the same VLANs, at least one MST instance, and the same MST region name. Therefore, switches can use different paths in the network to effectively balance loads.

This page allows you to examine and change the configurations of current MSTI ports. A MSTI port is a virtual port, which is instantiated separately for each active CIST (physical) port for each MSTI instance configured and applicable for the port. The MSTI instance must be selected before MSTI port configuration options are displayed.

MSTI Configuration

Add VLANs separated by spaces or comma.

Unmapped VLANs are mapped to the CIST. (The default bridge instance).

Configuration Identification

Configuration Name	00-1e-94-12-23-34
Configuration Revision	0

MSTI Mapping

MSTI	VLANs Mapped
MSTI1	
MSTI2	
MSTI3	
MSTI4	
MSTI5	
MSTI6	
MSTI7	

Label	Description
Configuration Name	The name which identifies the VLAN to MSTI mapping. Bridges must share the name and revision (see below), as well as the VLAN-to-MSTI mapping configurations in order to share spanning trees for MSTIs (intra-region). The name should not exceed 32 characters.
Configuration Revision	Revision of the MSTI configuration named above. This must be an integer between 0 and 65535.
MSTI	The bridge instance. The CIST is not available for explicit mapping, as it will receive the VLANs not explicitly mapped.
VLANS Mapped	The list of VLANs mapped to the MSTI. The VLANs must be separated with commas and/or space. A VLAN can only be mapped to one MSTI. An unused MSTI will be left empty (ex. without any mapped VLANs).

Priority

This page allows you to examine and change the configurations of current STP MSTI bridge instance priority.

The screenshot shows a web interface titled "MSTI Configuration". Inside, there is a sub-section titled "MSTI Priority Configuration" containing a table with two columns: "MSTI" and "Priority". The table lists instances from CIST to MST7, each with a priority value of 128 and a dropdown arrow. Below the table are "Save" and "Reset" buttons.

MSTI	Priority
CIST	128
MST1	128
MST2	128
MST3	128
MST4	128
MST5	128
MST6	128
MST7	128

Label	Description
MSTI	The bridge instance. CIST is the default instance, which is always active.
Priority	Indicates bridge priority. The lower the value, the higher the priority. The bridge priority, MSTI instance number, and the 6-byte MAC address of the switch forms a bridge identifier.

Save	Click to save changes
Reset	Click to undo any changes made locally and revert to previously saved values

5.2.3 CIST

With the ability to cross regional boundaries, CIST is used by MSTP to communicate with other MSTP regions and with any RSTP and STP single-instance spanning trees in the network. Any boundary port, that is, if it is connected to another region, will automatically belongs solely to CIST, even if it is assigned to an MSTI. All VLANs that are not members of particular MSTIs are members of the CIST.

Port Settings

STP CIST Ports Configuration

CIST Aggregated Ports Configuration

Port	STP Enabled	Path Cost	Priority	Admin Edge	Auto Edge	Restricted Role	TCN	BPDU Guard	Point-to-point
-	<input type="checkbox"/>	Auto	128	Edge	<input checked="" type="checkbox"/>	<input type="checkbox"/>	<input type="checkbox"/>	<input type="checkbox"/>	Forced True

CIST Normal Ports Configuration

Port	STP Enabled	Path Cost	Priority	Admin Edge	Auto Edge	Restricted Role	TCN	BPDU Guard	Point-to-point
1	<input type="checkbox"/>	Auto	128	Edge	<input checked="" type="checkbox"/>	<input type="checkbox"/>	<input type="checkbox"/>	<input type="checkbox"/>	Auto
2	<input type="checkbox"/>	Auto	128	Edge	<input checked="" type="checkbox"/>	<input type="checkbox"/>	<input type="checkbox"/>	<input type="checkbox"/>	Auto
3	<input type="checkbox"/>	Auto	128	Edge	<input checked="" type="checkbox"/>	<input type="checkbox"/>	<input type="checkbox"/>	<input type="checkbox"/>	Auto
4	<input type="checkbox"/>	Auto	128	Edge	<input checked="" type="checkbox"/>	<input type="checkbox"/>	<input type="checkbox"/>	<input type="checkbox"/>	Auto
5	<input type="checkbox"/>	Auto	128	Edge	<input checked="" type="checkbox"/>	<input type="checkbox"/>	<input type="checkbox"/>	<input type="checkbox"/>	Auto
6	<input type="checkbox"/>	Auto	128	Edge	<input checked="" type="checkbox"/>	<input type="checkbox"/>	<input type="checkbox"/>	<input type="checkbox"/>	Auto

Label	Description
Port	The switch port number to which the following settings will be applied.
STP Enabled	Check to enable STP for the port
Path Cost	Configures the path cost incurred by the port. Auto will set the path cost according to the physical link speed by using the 802.1D-recommended values. Specific allows you to enter a user-defined value. The path cost is used when establishing an active topology for the network. Lower path cost ports are chosen as forwarding ports in favor of higher path cost ports. The range of valid values is 1 to 200000000.
Priority	Configures the priority for ports having identical port costs. (See above).
OpenEdge (setate flag)	A flag indicating whether the port is connected directly to edge devices or not (no bridges attached). Transiting to the forwarding state is faster for edge ports (operEdge set to true) than other ports.
AdminEdge	Configures the operEdge flag to start as set or cleared.(the initial operEdge state when a port is initialized).

AutoEdge	Check to enable the bridge to detect edges at the bridge port automatically. This allows operEdge to be derived from whether BPDUs are received on the port or not.
Restricted Role	When enabled, the port will not be selected as root port for CIST or any MSTI, even if it has the best spanning tree priority vector. Such a port will be selected as an alternate port after the root port has been selected. If set, spanning trees will lose connectivity. It can be set by a network administrator to prevent bridges outside a core region of the network from influencing the active spanning tree topology because those bridges are not under the full control of the administrator. This feature is also known as Root Guard.
Restricted TCN	When enabled, the port will not propagate received topology change notifications and topology changes to other ports. If set, it will cause temporary disconnection after changes in an active spanning trees topology as a result of persistent incorrectly learned station location information. It is set by a network administrator to prevent bridges outside a core region of the network from causing address flushing in that region because those bridges are not under the full control of the administrator or is the physical link state for the attached LANs transitions frequently.
Point2Point	Configures whether the port connects to a point-to-point LAN rather than a shared medium. This can be configured automatically or set to true or false manually. Transiting to forwarding state is faster for point-to-point LANs than for shared media.
Save	Click to save changes.
Reset	Click to undo any changes made locally and revert to previously saved values.

5.2.4 MSTI Ports

This page allows you to configure STA attributes for interfaces in a specific MSTI, including path cost, and port priority. You may use a different priority or path cost for ports of the same media type to indicate the preferred path.

MSTI Aggregated Ports Configuration		
Port	Path Cost	Priority
-	Auto ▼	128 ▼

MSTI Normal Ports Configuration		
Port	Path Cost	Priority
*	<> ▼	<> ▼
1	Auto ▼	128 ▼
2	Auto ▼	128 ▼
3	Auto ▼	128 ▼
4	Auto ▼	128 ▼
5	Auto ▼	128 ▼
6	Auto ▼	128 ▼

Label	Description
Port	The port identifier.
Path Cost	As this parameter is used by the STA to determine the best path between devices, lower values are suggested for ports attached to faster media, and higher values for ports with slower media. (Path cost takes precedence over port priority.) The value will control the path cost incurred by the port. Auto will set the path cost as appropriate by the physical link speed, using the 802.1D recommended values. Specific will allow you to enter a user-defined value.
Priority	Specify the priority for a port in the Spanning Tree Algorithm. If the path cost for all ports on a switch are the same, the port with the highest priority (usually with the lowest value) will be used as an active link in the Spanning Tree. In this way, a port with higher priority is less likely to be blocked if the Spanning Tree Algorithm discovers network loops. Where more than one port is assigned the highest priority, the port with lowest numeric identifier will be enabled.

5.2.5 Bridge Status

This page will show STA information on the global bridge such as the switch and individual ports.

STP Bridges

Auto-refresh Refresh

MSTI	Bridge ID	Root			Topology Flag	Topology Change Last
		ID	Port	Cost		
CIST	32768.00-1E-94-12-23-34	32768.00-1E-94-12-23-34	-	0	Steady	-

Label	Description
MSTI	Indicates the bridge instance.
Bridge ID	A unique identifier for this bridge, consisting of the bridge priority, and MAC address (where the address is taken from the switch system).
Root	<p>Root ID: A unique identifier of the device in the Spanning Tree that this switch has been accepted as the root device, consisting of the priority and MAC address.</p> <p>Root Port: the number of the port on this switch that is closest to the root. This switch communicates with the root device through this port. If no root port is designated, it means this switch has been accepted as the root device of the Spanning Tree network.</p> <p>Root Cost: the path cost from the root port on this switch to the root device. The cost for the root bridge zero. For all other bridges, it is the sum of the port path costs on the least cost path to the root bridge.</p>
Technology Flag	The current state of the Topology Change Notification flag (TCN) for this bridge instance.
Technology Change Last	Time since the Spanning Tree was last reconfigured.

Click on CIST will bring out the following information window. Regional Root is the bridge ID of the designated regional root bridge, inside the MSTP region of this bridge. Internal Root Path is the path cost regional root path cost. The cost for the Regional Root Bridge is zero, and for all other CIST instances in the same MSTP region, it is the sum of the Internal Port Path Costs on the least cost path to the Internal Root Bridge. Note that these parameters only apply to the CIST instance.

STP Detailed Bridge Status

Auto-refresh Refresh

STP Bridge Status	
Bridge Instance	CIST
Bridge ID	32768.00-1E-94-12-23-34
Root ID	32768.00-1E-94-12-23-34
Root Cost	0
Root Port	-
Regional Root	32768.00-1E-94-12-23-34
Internal Root Cost	0
Topology Flag	Steady
Topology Change Count	0
Topology Change Last	-

CIST Ports & Aggregations State

Port	Port ID	Role	State	Path Cost	Edge	Point-to-Point	Uptime
No ports or aggregations active							

Label	Description
Port	The port identifier.
Port ID	The port identifier used by the RSTP protocol, consisting of the priority and the logical port index of the bridge port.
Role	The role of a port is assigned based on whether it is part of the active topology connecting the bridge to the root bridge (i.e., root port), connecting a LAN through the bridge to the root bridge (i.e., designated port); or is an alternate or backup port that may provide connectivity if other bridges, bridge ports, or LANs fail or are removed.
State	Displays the current state of this port in the Spanning Tree.
Path Cost	The path cost of the port contributed to the paths towards the spanning tree root which include this port. It can be a value assigned by the Auto setting or any explicitly configured value.
Edge	The current RSTP port (operational) Edge Flag. An Edge Port is a switch port to which no bridges are attached. The flag may be automatically computed or explicitly configured. Each Edge Port transitions directly to the Forwarding Port State, since there is no possibility of it participating in a loop.
Point-to-Point	Indicates a connection to exactly one other bridge. The flag may be automatically computed or explicitly configured. The point-to-point properties of a port affect how fast it can

	transition RSTP states.
Uptime	The time since the bridge port was last initialized.

5.2.6 Port Status

This page shows the STA functional status of participating ports.

The screenshot shows a web interface titled "STP Port Status". It includes an "Auto-refresh" checkbox (unchecked) and a "Refresh" button. Below is a table with the following data:

Port	CIST Role	CIST State	Uptime
1	Non-STP	Forwarding	-
2	Non-STP	Forwarding	-
3	Non-STP	Forwarding	-
4	Non-STP	Forwarding	-
5	Non-STP	Forwarding	-
6	Non-STP	Forwarding	-
7	Non-STP	Forwarding	-
8	Non-STP	Forwarding	-
9	Non-STP	Forwarding	-
10	Non-STP	Forwarding	-
11	Non-STP	Forwarding	-
12	Non-STP	Forwarding	-
13	Non-STP	Forwarding	-
14	Non-STP	Forwarding	-
15	Non-STP	Forwarding	-
16	Non-STP	Forwarding	-
17	Non-STP	Forwarding	-
18	Non-STP	Forwarding	-
19	Non-STP	Forwarding	-
20	Non-STP	Forwarding	-

Label	Description
Port	The port identifier.
CIST Role	The role of a port is assigned based on whether it is part of the active topology connecting the bridge to the root bridge (i.e., root port), connecting a LAN through the bridge to the root bridge (i.e., designated port); or is an alternate or backup port that may provide connectivity if other bridges, bridge ports, or LANs fail or are removed.
CIST State	Displays the current state of this port in the Spanning Tree. There are three states. Blocking: the port will receive STA configuration messages, but will not forward packets. Learning: The port transmits configuration messages for an

	interval set by the Forward Delay parameter without receiving contradictory information. The port address table will be cleared, and the port will learn addresses. Forwarding: The port will forward packets while learning addresses.
Uptime	The time since the bridge port was last initialized.

5.2.7 Port Statistics

STP Statistics

Auto-refresh Refresh Clear

Port	Transmitted				Received				Discarded	
	MSTP	RSTP	STP	TCN	MSTP	RSTP	STP	TCN	Unknown	Illegal
No ports enabled										

Label	Description
Port	The port identifier.
Transmitted/Received	MSTP: the number of MSTP Configuration BPDUs received/transmitted on a port. RSTP: the number of RSTP Configuration BPDUs received/transmitted on a port. RTP: the number of legacy STP Configuration BPDUs received/transmitted on a port. TCN: the number of (legacy) Topology Change Notification BPDUs received/transmitted on a port.
Discarded	Unknown: the number of unknown Spanning Tree BPDUs received (and discarded) on a port. Illegal: the number of illegal Spanning Tree BPDUs received (and discarded) on a port.

Management

The switch can be controlled via a built-in web server which supports Internet Explorer (Internet Explorer 5.0 or above versions) and other Web browsers such as Chrome. Therefore, you can manage and configure the switch easily and remotely. You can also upgrade firmware via a web browser. The Web management function not only reduces network bandwidth consumption, but also enhances access speed and provides a user-friendly viewing screen.



By default, IE5.0 or later version do not allow Java applets to open sockets. You need to modify the browser setting separately in order to enable Java applets for network ports.

Preparing for Web Management

You can access the management page of the switch via the following default values:

IP Address: **192.168.10.1**

Subnet Mask: **255.255.255.0**

Default Gateway: **192.168.10.254**

User Name: **admin**

Password: **admin**

System Login

1. Launch the Internet Explorer.
2. Type `http://` and the IP address of the switch. Press **Enter**.

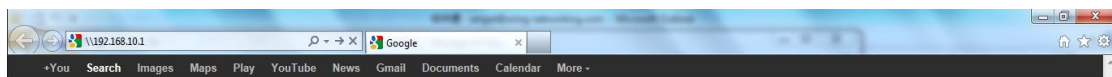

3. A login screen appears.
4. Type in the username and password. The default username and password is **admin**.
5. Click **Enter** or **OK** button, the management Web page appears.



After logging in, you can see the information of the switch as below.

System Information

System	
Name	IGPS-9822DGP+
Description	Industrial 12-port managed Gigabit PoE Ethernet switch with 8x10/100/1000Base-T(X) P.S.E. ports and 2x100/1G/2.5GBase-X + 2x1G/10GBase-X, SFP socket.
Location	
Contact	
OID	1.3.6.1.4.1.25972.100.0.0.303
Hardware	
MAC Address	00-1e-94-00-00-21
Time	
System Date	1970-01-01T00:08:12+00:00
System Uptime	0d 00:08:12
Software	
Kernel Version	K12.46
Software Version	V1.00
Software Date	2018-08-10T15:39:29+08:00
Auto-refresh <input type="checkbox"/>	<input type="button" value="Refresh"/>

On the left hand side of the management interface shows links to various settings. You can click on the links to access the configuration pages of different functions.

6.1 Basic Settings

Basic Settings allow you to configure the basic functions of the switch.

6.1.1 System Information

This page shows the general information of the switch.

System Information Configuration	
System Name	IGPS-9822DGP+
System Description	Industrial 12-port managed Gig
System Location	
System Contact	
<input type="button" value="Save"/> <input type="button" value="Reset"/>	

Label	Description
System Name	An administratively assigned name for the managed node. By convention, this is the node's fully-qualified domain name. A domain name is a text string consisting of alphabets (A-Z, a-z), digits (0-9), and minus sign (-). Space is not allowed to be part of the name. The first character must be an alpha character. And the first or last character must not be a minus sign. The allowed string length is 0 to 255.
System Description	Description of the device
System Location	The physical location of the node (e.g., telephone closet, 3rd floor). The allowed string length is 0 to 255, and only ASCII characters from 32 to 126 are allowed.
System Contact	The textual identification of the contact person for this managed node, together with information on how to contact this person. The allowed string length is 0 to 255, and only ASCII characters from 32 to 126 are allowed.
Save	Click to save changes.
Reset	Click to undo any changes made locally and revert to previously saved values.

6.1.2 Auth Method

Authentication Method Configuration

The authentication section allows you to configure how a user is authenticated when he logs into the switch via one of the management client interfaces.

Authentication Method Configuration

Client	Methods		
console	local ▼	no ▼	no ▼
telnet	local ▼	no ▼	no ▼
ssh	local ▼	no ▼	no ▼
http	local ▼	no ▼	no ▼

Label	Description
Client	The management client for which the configuration below applies.
Methods	Method can be set to one of the following values: <ul style="list-style-type: none"> · no: Authentication is disabled and login is not possible. · local: Use the local user database on the switch for authentication. · radius: Use remote RADIUS server(s) for authentication. · tacacs: Use remote TACACS+ server(s) for authentication.

Command Authorization Method Configuration

The command authorization section allows you to limit the CLI commands available to a user.

Command Authorization Method Configuration

Client	Method	Cmd Lvl	Cfg Cmd
console	no ▼	0	<input type="checkbox"/>
telnet	no ▼	0	<input type="checkbox"/>
ssh	no ▼	0	<input type="checkbox"/>

Label	Description
Client	The management client for which the configuration below applies.
Methods	Method can be set to one of the following values: <ul style="list-style-type: none"> · no: Command authorization is disabled. User is granted access

	<p>to CLI commands according to his privilege level.</p> <ul style="list-style-type: none"> · tacacs: Use remote TACACS+ server(s) for command authorization. If all remote servers are offline, the user is granted access to CLI commands according to his privilege level.
--	---

Accounting Method Configuration

The accounting section allows you to configure command and exec (login) accounting.

Client	Method	Cmd Lvl	Exec
console	tacacs ▼		<input type="checkbox"/>
telnet	no ▼		<input type="checkbox"/>
ssh	no ▼		<input type="checkbox"/>

Save Reset

Label	Description
Client	The management client for which the configuration below applies.
Methods	Method can be set to one of the following values: <ul style="list-style-type: none"> · no: Accounting is disabled. · tacacs: Use remote TACACS+ server(s) for accounting.
Cmd Lvl	Enable accounting of all commands with a privilege level higher than or equal to this level. Valid values are in the range of 0 to 15. Leave the field empty to disable command accounting.
Exec	Enable exec (login) accounting.

6.1.3 Users Configuration

This page provides an overview of the current users. Currently the only way to login as another user on the web server is to close and reopen the browser.

Label	Description
User Name	A string identifying the user name that this entry should belong to. The allowed string length is 1 to 31. The valid user name can be letters, numbers and underscores.
Password	The password of the user. The allowed string length is 0 to 31. Any printable characters including space are accepted.
Privilege Level	The privilege level of the user. The allowed range is 0 to 15. If the privilege level value is 15, it can access all groups, i.e. that is granted the fully control of the device. But other values need to refer to each group privilege level. User's privilege should be the same or greater than the group privilege level to have the access of that group. By default, the group privilege level of 5 has the read-only access and the privilege level of 10 has the read-write access. System maintenance (software upload, factory defaults and etc.) requires the user privilege level of 15. Generally, the privilege level of 15 can be used for an administrator account, privilege level 10 for a standard user account and privilege level 5 for a guest account.

Privilege Levels

This page provides an overview of the privilege levels.

Privilege Level Configuration

Group Name	Privilege Levels			
	Configuration Read-only	Configuration/Execute Read/write	Status/Statistics Read-only	Status/Statistics Read/write
Aggregation	5 ▼	10 ▼	5 ▼	10 ▼
Debug	15 ▼	15 ▼	15 ▼	15 ▼
DEVICEBINDING	5 ▼	10 ▼	5 ▼	10 ▼
DHCP	5 ▼	10 ▼	5 ▼	10 ▼
DHCPv6_Client	5 ▼	10 ▼	5 ▼	10 ▼
Diagnostics	5 ▼	10 ▼	5 ▼	10 ▼
FastRecovery	5 ▼	10 ▼	5 ▼	10 ▼
INTP	5 ▼	10 ▼	5 ▼	10 ▼
IP	5 ▼	10 ▼	5 ▼	10 ▼

Label	Description
Group Name	<p>The name identifying the privilege group. In most cases, a privilege level group consists of a single module (e.g. LACP, RSTP or QoS), but a few of them contains more than one. The following description defines these privilege level groups in details:</p> <p>System: Contact, Name, Location, Timezone, Daylight Saving Time, Log.</p> <p>Security: Authentication, System Access Management, Port (contains Dot1x port, MAC based and the MAC Address Limit), ACL, HTTPS, SSH, IP source guard.</p> <p>IP: Everything except 'ping'.</p> <p>Port: Everything except 'VeriPHY'.</p> <p>Diagnostics: 'ping' and 'VeriPHY'.</p> <p>Maintenance: CLI- System Reboot, System Restore Default, System Password, Configuration Save, Configuration Load and Firmware Load. Web- Users, Privilege Levels and everything in Maintenance.</p> <p>Debug: Only present in CLI.</p>
Privilege Levels	<p>Every group has an authorization Privilege level for the following sub groups: configuration read-only, configuration/execute read-write, status/statistics read-only, status/statistics read-write (e.g. for clearing of statistics). User Privilege should be same or greater than the authorization Privilege level to have the access to that group.</p>

6.1.4 IP Settings

This page allows you to configure IP information for the switch. You can configure the settings of the device operating in host or router mode.

IP Configuration

This page provides an overview of the privilege levels.

IP Configuration										
VLAN	DHCPv4			IPv4		DHCPv6			IPv6	
	Enable	Fallback	Current Lease	Address	Mask Length	Enable	Rapid Commit	Current Lease	Address	Mask Length
1	<input type="checkbox"/>	0		192.168.10.1	24	<input type="checkbox"/>	<input type="checkbox"/>			
Gateway										
192.168.10.254										
Save Reset										

Label	Description
VLAN	The VLAN associated with the IP interface. Only ports in this VLAN will be able to access the IP interface. This field is only available for input when creating a new interface.
IPv4 DHCP Enabled	Enable the DHCPv4 client by checking this box. If this option is enabled, the system will configure the IPv4 address and mask of the interface using the DHCPv4 protocol. The DHCPv4 client will announce the configured System Name as hostname to provide DNS lookup.
IPv4 DHCP Fallback Timeout	The number of seconds for trying to obtain a DHCP lease. After this period expires, a configured IPv4 address will be used as IPv4 interface address. A value of zero disables the fallback mechanism, such that DHCP will keep retrying until a valid lease is obtained. Legal values are 0 to 4294967295 seconds.
IPv4 DHCP Current Lease	For DHCP interfaces with an active lease, this column show the current interface address, as provided by the DHCP server.
IPv4 Address	The IPv4 address of the interface in dotted decimal notation. If DHCP is enabled, this field configures the fallback address. The field may be left blank if IPv4 operation on the interface is not desired - or no DHCP fallback address is desired.
IPv4 Mask	The IPv4 network mask, in number of bits (<i>prefix length</i>). Valid values are between 0 and 30 bits for an IPv4 address. If DHCP is enabled, this field configures the fallback address

	network mask. The field may be left blank if IPv4 operation on the interface is not desired - or no DHCP fallback address is desired.
DHCPv6 Enable	Enable the DHCPv6 client by checking this box. If this option is enabled, the system will configure the IPv6 address of the interface using the DHCPv6 protocol.
DHCPv6 Rapid Commit	Enable the DHCPv6 Rapid-Commit option by checking this box. If this option is enabled, the DHCPv6 client terminates the waiting process as soon as a Reply message with a Rapid Commit option is received. This option is only manageable when DHCPv6 client is enabled.
DHCPv6 Current Lease	For DHCPv6 interface with an active lease, this column shows the interface address provided by the DHCPv6 server.
IPv6 Address	The IPv6 address of the interface. An IPv6 address is in 128-bit records represented as eight fields of up to four hexadecimal digits with a colon separating each field (:). For example, fe80::215:c5ff:fe03:4dc7. The symbol :: is a special syntax that can be used as a shorthand way of representing multiple 16-bit groups of contiguous zeros; but it can appear only once. System accepts the valid IPv6 unicast address only, except IPv4-Compatible address and IPv4-Mapped address. This field may be left blank if IPv6 operation on the interface is not desired.
IPv6 Mask	The IPv6 network mask, in number of bits (<i>prefix length</i>). Valid values are between 1 and 128 bits for an IPv6 address. This field may be left blank if IPv6 operation on the interface is not desired.
Resolving IPv6 DAD	The link-local address is formed from an interface identifier based on the hardware address which is supposed to be uniquely assigned. Once the DAD (Duplicate Address Detection) detects the address duplication, the operation on the interface SHOULD be disabled. At this moment, manual intervention is required to resolve the address duplication. For example, check whether the loop occurs in the VLAN or there is indeed other device occupying the same hardware address as the device in the VLAN. After making sure the specific link-local address is unique on the

	IPv6 link in use, delete and then add the specific IPv6 interface to restart the IPv6 operations on this interface.
Gateway	Input gateway address .

6.1.5 IP Status

This page displays the status of the IP protocol layer. The status is defined by the IP interfaces, the IP routes and the neighbor cache (ARP cache) status.

IP Interfaces

Interface	Type	Address	Status
OS:lo	LINK	00-00-00-00-00-00	<UP LOOPBACK RUNNING MULTICAST>
OS:lo	IPv4	127.0.0.1/8	
OS:lo	IPv6	fe80::1/64	
OS:lo	IPv6	::1/128	
VLAN1	LINK	00-1e-94-12-23-34	<UP BROADCAST RUNNING MULTICAST>
VLAN1	IPv4	192.168.10.1/24	
VLAN1	IPv6	fe80::21e:94ff:fe12:2334/64	

IP Routes

Network	Gateway	Status
127.0.0.1/32	127.0.0.1	<UP HOST>
224.0.0.0/4	127.0.0.1	<UP>
::1/128	::1	<UP HOST>

Neighbour cache

IP Address	Link Address
192.168.10.66	VLAN1:18-66-da-40-88-11
fe80::21e:94ff:fe12:2334	VLAN1:00-1e-94-12-23-34

Label	Description
IP Interface	
Interface	The name of the interface.
Type	The address type of the entry. This may be LINK or IPv4.
Address	The current address of the interface (of the given type).
Status	The status flags of the interface (and/or address).
IP Routes	
Network	The destination IP network or host address of this route.
Gateway	The gateway address of this route.
Status	The status flags of the route.
Neighbor Cache	
IP Address	The IP address of the entry.
Link Address	The Link (MAC) address for which a binding to the IP address given exist.

6.1.6 Daylight Saving Time

Time Zone Configuration

Time Zone	None
Acronym	(0 - 16 characters)

Daylight Saving Time Configuration

Daylight Saving Time Mode

Daylight Saving Time	Disabled
----------------------	----------

Start Time settings

Month	Jan
Date	1
Year	2014
Hours	0
Minutes	0

End Time settings

Month	Jan
Date	1
Year	2097
Hours	0
Minutes	0

Offset settings

Offset	1	(1 - 1440) Minutes
--------	---	--------------------

Save
Reset

Label	Description
Time Zone Configuration	<p>Time Zone: Set the switch location time zone. The following table lists the different location time zone for your reference.</p> <p>Acronym: User can set the acronym of the time zone. This is a User configurable acronym to identify the time zone. (Range: Up to 16 alpha-numeric characters and can contain '-', '_' or '.').</p>
Daylight Saving Time Configuration	<p>Daylight Saving Time Mode: Enable or disable daylight saving time function. This is used to set the clock forward or backward according to the configurations set below for a defined daylight saving time duration. Select 'Disable' to disable the daylight saving time configuration. Select 'Recurring' and configure the Daylight Saving Time duration to repeat the configuration every year. Select 'Non-Recurring' and configure the daylight saving time duration for single time configuration. (Default : Disabled).</p> <p>Start Time Settings: Set up the start time of the daylight saving time period.</p>

	<p>End Time Settings: Set up the ending time of the daylight saving time period.</p> <p>Offset Settings: Set up the offset time.</p>
--	--

Local Time Zone	Conversion from UTC	Time at 12:00 UTC
November Time Zone	- 1 hour	11 am
Oscar Time Zone	-2 hours	10 am
ADT - Atlantic Daylight	-3 hours	9 am
AST - Atlantic Standard EDT - Eastern Daylight	-4 hours	8 am
EST - Eastern Standard CDT - Central Daylight	-5 hours	7 am
CST - Central Standard MDT - Mountain Daylight	-6 hours	6 am
MST - Mountain Standard PDT - Pacific Daylight	-7 hours	5 am
PST - Pacific Standard ADT - Alaskan Daylight	-8 hours	4 am
ALA - Alaskan Standard	-9 hours	3 am
HAW - Hawaiian Standard	-10 hours	2 am
Nome, Alaska	-11 hours	1 am
CET - Central European FWT - French Winter MET - Middle European MEWT - Middle European Winter SWT - Swedish Winter	+1 hour	1 pm
EET - Eastern European, USSR Zone 1	+2 hours	2 pm
BT - Baghdad, USSR Zone 2	+3 hours	3 pm

ZP4 - USSR Zone 3	+4 hours	4 pm
ZP5 - USSR Zone 4	+5 hours	5 pm
ZP6 - USSR Zone 5	+6 hours	6 pm
WAST - West Australian Standard	+7 hours	7 pm
CCT - China Coast, USSR Zone 7	+8 hours	8 pm
JST - Japan Standard, USSR Zone 8	+9 hours	9 pm
EAST - East Australian Standard GST Guam Standard, USSR Zone 9	+10 hours	10 pm
IDLE - International Date Line NZST - New Zealand Standard NZT - New Zealand	+12 hours	Midnight

6.1.7 HTTPS

You can configure the HTTPS mode in this page.

HTTPS Configuration

Mode	Enabled ▼
Automatic Redirect	Disabled ▼
Certificate Maintain	None ▼
Certificate Status	Switch secure HTTP certificate is presented

Label	Description
Mode	Enables or disables HTTPS mode.
Automatic Redirect	Enables or disables automatic redirect function. It is only significant when HTTPS mode is enabled. When the redirect mode is enabled, the HTTP connection will be redirected to HTTPS connection automatically. Notice that the browser may not allow redirection due to security considerations unless the switch certificate is trusted to the browser. You need to initialize the HTTPS connection manually for this case.
Certificate Maintain	The operation of certificate maintenance including:

	<p>None: No operation.</p> <p>Delete: Delete the current certificate.</p> <p>Upload: Upload a certificate PEM file through a Web browser or URL.</p> <p>Generate: Generate a new self-signed RSA certificate.</p>
Certificate Status	<p>Display the current status of certificate on the switch.</p> <p>Possible statuses are:</p> <p>Switch secure HTTP certificate is presented.</p> <p>Switch secure HTTP certificate is not presented.</p> <p>Switch secure HTTP certificate is generating.</p>

6.1.8 SSH

You can configure the SSH mode in this page.

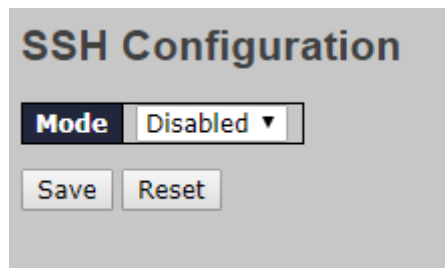

Label	Description
Mode	Enable or disable SSH.
Save	Click to save changes
Reset	Click to undo any changes made locally and revert to previously saved values.

6.1.9 DBU01 Option Config

DBU01 is ORing Design ,backup/ restore unit . user can use DBU-01 Quickly restore/ backup switch configure , don't need use PC., In this page , user can enable or disable ,

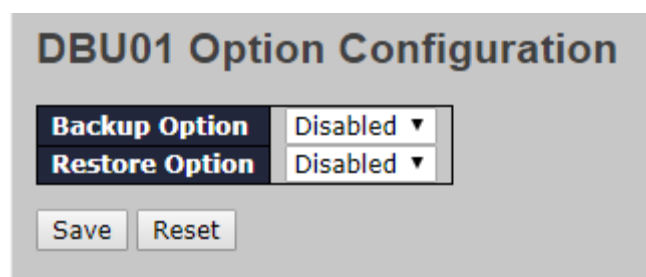

6.1.10 LLDP

LLDP Configurations

This page allows you to examine and configure current LLDP port settings.

LLDP Configuration

LLDP Parameters

Tx Interval	30	seconds
Tx Hold	4	times
Tx Delay	2	seconds
Tx Reinit	2	seconds

Label	Description
Tx Interval	The switch periodically transmits LLDP frames to its neighbors to update the network discovery information. The interval between each LLDP frame is determined by the Tx Interval value which must be between 5 - 32768 seconds.
Tx Hold	Each LLDP frame contains information about how long time the information in the LLDP frame shall be considered valid. The LLDP information valid period is set to Tx Hold multiplied by Tx Interval seconds. Valid values must be between 2 - 10 times.
Tx Delay	When a setting is changed (e.g. the IP address), a new LLDP frame is transmitted, but the time between the LLDP frames will always be at least the value of Tx Delay seconds. Tx Delay cannot be larger than 1/4 of the Tx Interval value. Valid values must be between 1 - 8192 seconds.
Tx Reinit	When an interface is disabled, LLDP is disabled or the switch is rebooted, a LLDP shutdown frame is transmitted to the neighboring units, signaling that the LLDP information isn't valid anymore. Tx Reinit controls the amount of seconds between the shutdown frame and a new LLDP initialization. Valid values must be between 1 - 10 seconds.

LLDP Interface Configuration						
Interface	Mode	Optional TLVs				
		Port Descr	Sys Name	Sys Descr	Sys Capa	Mgmt Addr
*	<>	<input checked="" type="checkbox"/>	<input checked="" type="checkbox"/>	<input checked="" type="checkbox"/>	<input checked="" type="checkbox"/>	<input checked="" type="checkbox"/>
GigabitEthernet 1/1	Enabled	<input checked="" type="checkbox"/>	<input checked="" type="checkbox"/>	<input checked="" type="checkbox"/>	<input checked="" type="checkbox"/>	<input checked="" type="checkbox"/>
GigabitEthernet 1/2	Enabled	<input checked="" type="checkbox"/>	<input checked="" type="checkbox"/>	<input checked="" type="checkbox"/>	<input checked="" type="checkbox"/>	<input checked="" type="checkbox"/>
GigabitEthernet 1/3	Enabled	<input checked="" type="checkbox"/>	<input checked="" type="checkbox"/>	<input checked="" type="checkbox"/>	<input checked="" type="checkbox"/>	<input checked="" type="checkbox"/>
GigabitEthernet 1/4	Enabled	<input checked="" type="checkbox"/>	<input checked="" type="checkbox"/>	<input checked="" type="checkbox"/>	<input checked="" type="checkbox"/>	<input checked="" type="checkbox"/>
GigabitEthernet 1/5	Enabled	<input checked="" type="checkbox"/>	<input checked="" type="checkbox"/>	<input checked="" type="checkbox"/>	<input checked="" type="checkbox"/>	<input checked="" type="checkbox"/>
GigabitEthernet 1/6	Enabled	<input checked="" type="checkbox"/>	<input checked="" type="checkbox"/>	<input checked="" type="checkbox"/>	<input checked="" type="checkbox"/>	<input checked="" type="checkbox"/>

Label	Description
Interface	The switch interface name of the logical LLDP interface.
Mode	Select a LLDP mode from the drop down list. Rx only: The switch will not send out LLDP information, but LLDP information from neighbor units is analyzed. Tx only: The switch will drop LLDP information received from neighbors, but will send out LLDP information. Disabled: The switch will not send out LLDP information, and will drop LLDP information received from neighbors. Enabled: The switch will send out LLDP information, and will analyze LLDP information received from neighbors.
Port Descr	Optional TLV: When checked, the "port description" is included in LLDP information transmitted.
Sys Name	Optional TLV: When checked, the "system name" is included in LLDP information transmitted.
Sys Descr	Optional TLV: When checked, the "system description" is included in LLDP information transmitted.
Sys Capa	Optional TLV: When checked, the "system capability" is included in LLDP information transmitted.
Mgmt Addr	Optional TLV: When checked, the "management address" is included in LLDP information transmitted.

LLDP Neighbor Information

This page provides a status overview for all LLDP neighbors. The following table contains information for each port on which an LLDP neighbor is detected.

Auto-refresh Refresh

Local Port	Chassis ID	Remote Port ID	System Name	Port Description	System Capabilities	Management Address
Port 8	00-1E-94-12-45-78	7	IGS-9812GP	Port #7	Bridge(+)	192.168.10.14 (IPv4)

Label	Description
-------	-------------

Local Port	The port that you use to transmits and receives LLDP frames.
Chassis ID	The identification number of the neighbor sending out the LLDP frames.
Remote Port ID	The identification of the neighbor port
System Name	The name advertised by the neighbor.
Port Description	The description of the port advertised by the neighbor.
System Capabilities	<p>Description of the neighbor's capabilities. The capabilities include:</p> <ol style="list-style-type: none"> 1. Other 2. Repeater 3. Bridge 4. WLAN Access Point 5. Router 6. Telephone 7. DOCSIS Cable Device 8. Station Only 9. Reserved <p>When a capability is enabled, a (+) will be displayed. If the capability is disabled, a (-) will be displayed.</p>
Management Address	The neighbor's address which can be used to help network management. This may contain the neighbor's IP address.
Refresh	Click to refresh the page immediately.
Auto-refresh	Check to enable an automatic refresh of the page at regular intervals.

Port Statistics

This page provides an overview of all LLDP traffic. Two types of counters are shown. Global counters will apply settings to the whole switch stack, while local counters will apply settings to specified switches.

LLDP Global Counters

Global Counters	
Clear global counters	<input checked="" type="checkbox"/>
Neighbor entries were last changed	1970-01-01T00:00:00+00:00 (6549 secs. ago)
Total Neighbors Entries Added	0
Total Neighbors Entries Deleted	0
Total Neighbors Entries Dropped	0
Total Neighbors Entries Aged Out	0

LLDP Statistics Local Counters

Local Interface	Tx Frames	Rx Frames	Rx Errors	Frames Discarded	TLVs Discarded	TLVs Unrecognized	Org. Discarded	Age-Outs	Clear
*	*	*	*	*	*	*	*	*	<input checked="" type="checkbox"/>
GigabitEthernet 1/1	0	0	0	0	0	0	0	0	<input checked="" type="checkbox"/>
GigabitEthernet 1/2	0	0	0	0	0	0	0	0	<input checked="" type="checkbox"/>
GigabitEthernet 1/3	0	0	0	0	0	0	0	0	<input checked="" type="checkbox"/>

Global Counters

Label	Description
Clear Global Counters	If checked the global counters are cleared when Clear is pressed.
Neighbor entries were last changed	Shows the time when the last entry was last deleted or added. It also shows the time elapsed since the last change was detected.
Total Neighbors Entries Added	Shows the number of new entries added since switch reboot
Total Neighbors Entries Deleted	Shows the number of new entries deleted since switch reboot
Total Neighbors Entries Dropped	Shows the number of LLDP frames dropped due to full entry table
Total Neighbors Entries Aged Out	Shows the number of entries deleted due to expired time-to-live

Local Counters

Label	Description
Local Port	The port that receives or transmits LLDP frames
Tx Frames	The number of LLDP frames transmitted on the port
Rx Frames	The number of LLDP frames received on the port
Rx Errors	The number of received LLDP frames containing errors
Frames Discarded	If a port receives an LLDP frame, and the switch's internal table is full, the LLDP frame will be counted and discarded. This situation is known as "too many neighbors" in the LLDP standard. LLDP frames require a new entry in the table if Chassis ID or Remote Port ID is not included in the table. Entries are removed from the

	table when a given port links down, an LLDP shutdown frame is received, or when the entry ages out.
TLVs Discarded	Each LLDP frame can contain multiple pieces of information, known as TLVs (Type Length Value). If a TLV is malformed, it will be counted and discarded.
TLVs Unrecognized	The number of well-formed TLVs, but with an unknown type value
Org. Discarded	The number of organizationally TLVs received
Age-Outs	Each LLDP frame contains information about how long the LLDP information is valid (age-out time). If no new LLDP frame is received during the age-out time, the LLDP information will be removed, and the value of the age-out counter will be incremented.
Clear	If checked the counters for the specific interface are cleared when Clear is pressed.

6.1.11 NTP

The function allows you to specify the Network Time Protocol (NTP) servers to query for the current time to maintain an accurate time on the switch, ensuring the system log record meaningful dates and times for event entries. With NTP, the switch can set its internal clock periodically according to an NTP time server. Otherwise, the switch will only record the time from the factory default set at the last bootup. When the NTP client is enabled, the switch regularly sends a request for a time update to a configured time server. A maximum of five time servers are supported. The switch will attempt to poll each server in the configured sequence.

Label	Description
Mode	Select a NTP mode from the drop down list.
Server	Sets the IP address for up to five time servers. The switch will update the time from the servers, starting from the first to the

	fifth in sequence if any of them fails. The polling interval is fixed at 15 minutes.
--	--

6.1.12 Upnp

UPnP is an acronym for Universal Plug and Play. The goals of UPnP are to allow devices to connect seamlessly and to simplify the implementation of networks in the home (data sharing, communications, and entertainment) and in corporate environments for simplified installation of computer components

Label	Description
Mode	Indicates the UPnP operation mode. Possible modes are: Enabled: Enable UPnP mode operation. Disabled: Disable UPnP mode operation. When the mode is enabled, two ACEs are added automatically to trap UPNP related packets to CPU. The ACEs are automatically removed when the mode is disabled.
TTL	The TTL value is used by UPnP to send SSDP advertisement messages. Valid values are in the range 1 to 255.
Advertising Duration	The duration, carried in SSDP packets, is used to inform a control point or control points how often it or they should receive an SSDP advertisement message from this switch. If a control point does not receive any message within the duration, it will think that the switch no longer exists. Due to the unreliable nature of UDP, in the standard it is recommended that such refreshing of advertisements to be done at less than one-half of the advertising duration. In the implementation, the switch sends SSDP messages periodically at the interval one-half of the advertising duration minus 30 seconds. Valid values are in the range 100 to 86400.

6.1.13 ModbusTCP

Support Modbus TCP. (About Modbus please reference <http://www.modbus.org/>)

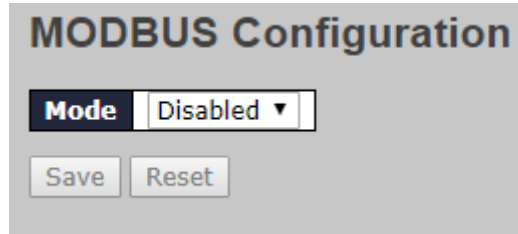

The following table describes the labels in this screen.

Label	Description
Mode	Enable or Disable Modbus TCP function

6.1.14 Ethernet/IP

EtherNet/IP is an industrial network protocol that adapts the Common Industrial Protocol to standard Ethernet.[1] EtherNet/IP is one of the leading industrial protocols in the United States and is widely used in a range of industries including factory, hybrid and process.

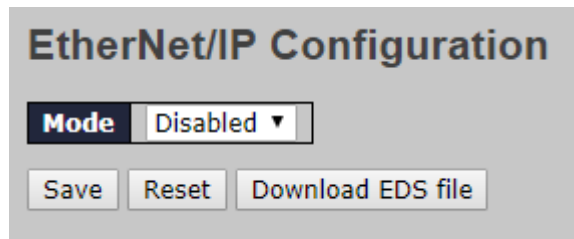

Label	Description
Mode	Indicates the EtherNet/IP mode operation. Possible modes are: Enabled: Enable EtherNet/IP mode operation. Disabled: Disable EtherNet/IP mode operation.
Download EDS File	Download to EDS File .

6.1.15 Backup/Restore Configurations

You can save/view or load switch configurations.

Download Configuration

Select configuration file to save.

Please note: running-config may take a while to prepare for download.

File Name
<input type="radio"/> running-config
<input type="radio"/> default-config
<input type="radio"/> startup-config

Upload Configuration

File To Upload

未選擇任何檔案

Destination File

File Name	Parameters
<input type="radio"/> running-config	<input checked="" type="radio"/> Replace <input type="radio"/> Merge
<input type="radio"/> startup-config	
<input type="radio"/> Create new file	<input type="text"/>

6.1.16 Firmware Update

This page allows you to update the firmware of the switch.

Software Upload

未選擇任何檔案

6.2 DHCP

6.2.1 DHCP Server

This page configures global mode and VLAN mode to enable/disable DHCP server per system and per VLAN. and per VLAN.

Mode

DHCP Server Mode Configuration

Global Mode

Mode Enabled ▾

VLAN Mode

Delete	VLAN Range	Mode
Delete	-	Enabled ▾

Add VLAN Range

Label	Description
Global Mode	
Mode	Configure the operation mode per system. Possible modes are: Enabled: Enable DHCP server per system. Disabled: Disable DHCP server pre system.
VLAN Mode	
VLAN Range	Indicate the VLAN range in which DHCP server is enabled or disabled. The first VLAN ID must be smaller than or equal to the second VLAN ID. BUT, if the VLAN range contains only 1 VLAN ID, then you can just input it into either one of the first and second VLAN ID or both. On the other hand, if you want to disable existed VLAN range, then you can follow the steps. 1. Press Add VLAN Range to add a new VLAN range. 2. input the VLAN range that you want to disable. 3. choose Mode to be Disabled . 4. press Save to apply the change.

	Then, you will see the disabled VLAN range is removed from the DHCP Server mode configuration page.
Mode	Indicate the operation mode per VLAN. Possible modes are: Enabled: Enable DHCP server per VLAN. Disabled: Disable DHCP server pre VLAN.

Excluded IP

This page configures excluded IP addresses. DHCP server will not allocate these excluded IP addresses to DHCP client

Label	Description
IP Range	Define the IP range to be excluded IP addresses. The first excluded IP must be smaller than or equal to the second excluded IP. BUT, if the IP range contains only 1 excluded IP, then you can just input it to either one of the first and second excluded IP or both.

Pool

This page manages DHCP pools. According to the DHCP pool, DHCP server will allocate IP address and deliver configuration parameters to DHCP client.

Label	Description
Name	Configure the pool name that accepts all printable characters, except white space. If you want to configure the detail settings, you can click the pool name to go into the configuration page.
Type	Display which type of the pool is.

	<p>Network: the pool defines a pool of IP addresses to service more than one DHCP client.</p> <p>Host: the pool services for a specific DHCP client identified by client identifier or hardware address. If "-" is displayed, it means not defined.</p>
IP	Display network number of the DHCP address pool. If "-" is displayed, it means not defined.
Subnet Mask	Display subnet mask of the DHCP address pool. If "-" is displayed, it means not defined.
Lease Time	Display lease time of the pool.

Statistics

This page displays the database counters and the number of DHCP messages sent and received by DHCP server.

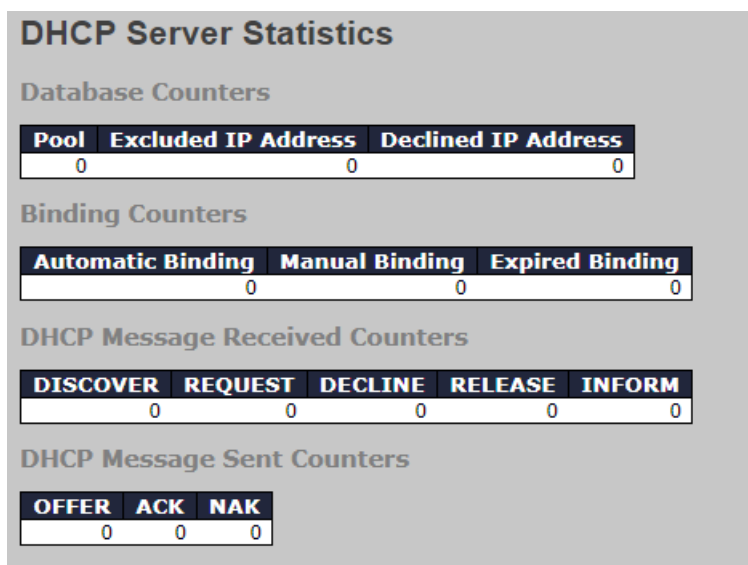

Label	Description
Database Counters	
Pool	Number of pools.
Excluded IP Address	Number of excluded IP address ranges.
Declined IP Address	Number of declined IP addresses.
Binding Counters	
Automatic Binding	Number of bindings with network-type pools.
Manual Binding	Number of bindings that administrator assigns an IP address to a

	client. That is, the pool is of host type.
Expired Binding	Number of bindings that their lease time expired or they are cleared from Automatic/Manual type bindings.
DHCP Message Received Counters	
DISCOVER	Number of DHCP DISCOVER messages received.
REQUEST	Number of DHCP REQUEST messages received.
DECLINE	Number of DHCP DECLINE messages received.
RELEASE	Number of DHCP RELEASE messages received.
INFORM	Number of DHCP INFORM messages received.
DHCP Message Sent Counters	
OFFER	Number of DHCP OFFER messages sent.
ACK	Number of DHCP ACK messages sent.
NAK	Number of DHCP NAK messages sent.

Binding

This page displays bindings generated for DHCP clients.

DHCP Server Binding IP

Binding IP Address

Delete	IP	Type	State	Pool Name	Server ID

Label	Description
IP	IP address allocated to DHCP client.
Type	Type of binding. Possible types are Automatic, Manual, Expired.
State	State of binding. Possible states are Committed, Allocated, Expired.
Pool Name	The pool that generates the binding.
Server ID	Server IP address to service the binding.

Declined IP

Display IP addresses declined by DHCP clients.

DHCP Server Declined IP

Declined IP Address

Declined IP

Label	Description
Declined IP	List of IP addresses declined.

6.2.2 DHCP Relay

DHCP relay is used to forward and transfer DHCP messages between the clients and the server when they are not in the same subnet domain. You can configure the function in this page.

DHCP Relay Configuration

Relay Mode	Disabled ▼
Relay Server	0.0.0.0
Relay Information Mode	Disabled ▼
Relay Information Policy	Keep ▼

Label	Description
Relay Mode	Indicates the existing DHCP relay mode. The modes include: Enabled: activate DHCP relay. When DHCP relay is enabled, the agent forwards and transfers DHCP messages between the clients and the server when they are not in the same subnet domain to prevent the DHCP broadcast message from flooding for security considerations. Disabled: disable DHCP relay
Relay Server	Indicates the DHCP relay server IP address. A DHCP relay agent is used to forward and transfer DHCP messages between the clients and the server when they are not in the same subnet domain.
Relay Information Mode	Indicates the existing DHCP relay information mode. The format of DHCP option 82 circuit ID format is "[vlan_id][module_id][port_no]". The first four characters represent the VLAN ID, and the fifth and

	<p>sixth characters are the module ID. In stand-alone devices, the module ID always equals to 0; in stacked devices, it means switch ID. The last two characters are the port number. For example, "00030108" means the DHCP message received from VLAN ID 3, switch ID 1, and port No. 8. The option 82 remote ID value equals to the switch MAC address.</p> <p>The modes include:</p> <p>Enabled: activate DHCP relay information. When DHCP relay information is enabled, the agent inserts specific information (option 82) into a DHCP message when forwarding to a DHCP server and removes it from a DHCP message when transferring to a DHCP client. It only works when DHCP relay mode is enabled.</p> <p>Disabled: disable DHCP relay information</p>
Relay Information Policy	<p>Indicates the policies to be enforced when receiving DHCP relay information. When DHCP relay information mode is enabled, if the agent receives a DHCP message that already contains relay agent information, it will enforce the policy. The Replace option is invalid when relay information mode is disabled. The policies includes:</p> <p>Replace: replace the original relay information when a DHCP message containing the information is received.</p> <p>Keep: keep the original relay information when a DHCP message containing the information is received.</p> <p>Drop: drop the package when a DHCP message containing the information is received.</p>

The relay statistics shows the information of relayed packets of the switch.

DHCP Relay Statistics							
Server Statistics							
Transmit to Server	Transmit Error	Receive from Server	Receive Missing Agent Option	Receive Missing Circuit ID	Receive Missing Remote ID	Receive Bad Circuit ID	Receive Bad Remote ID
0	0	0	0	0	0	0	0
Client Statistics							
Transmit to Client	Transmit Error	Receive from Client	Receive Agent Option	Replace Agent Option	Keep Agent Option	Drop Agent Option	
0	0	0	0	0	0	0	0

Label	Description
Transmit to Sever	The number of packets relayed from the client to the server
Transmit Error	The number of packets with errors when being sent to clients

Receive from Server	The number of packets received from the server
Receive Missing Agent Option	The number of packets received without agent information
Receive Missing Circuit ID	The number of packets received with Circuit ID
Receive Missing Remote ID	The number of packets received with the Remote ID option missing.
Receive Bad Circuit ID	The number of packets whose Circuit ID do not match the known circuit ID
Receive Bad Remote ID	The number of packets whose Remote ID do not match the known Remote ID
Transmit to Client	The number of packets relayed from the server to the client
Transmit Error	The number of packets with errors when being sent to servers
Receive from Client	The number of packets received from the server
Receive Agent Option	The number of received packets containing relay agent information
Replace Agent Option	The number of packets replaced when received messages contain relay agent information.
Keep Agent Option	The number of packets whose relay agent information is retained
Drop Agent Option	The number of packets dropped when received messages contain relay agent information.

6.2.3 DHCP Snooping

Snooping

Configure DHCP Snooping on this page.

DHCP Snooping Configuration

Snooping Mode Disabled ▼

Port Mode Configuration

Port	Mode
*	<> ▼
1	Trusted ▼
2	Trusted ▼
3	Trusted ▼

Label	Description
Snooping Mode	Indicates the DHCP snooping mode operation. Possible modes are: Enabled: Enable DHCP snooping mode operation. When DHCP snooping mode operation is enabled, the DHCP request messages will be forwarded to trusted ports and only allow reply packets from trusted ports. Disabled: Disable DHCP snooping mode operation.
Port Mode Configuration	Indicates the DHCP snooping port mode. Possible port modes are: Trusted: Configures the port as trusted source of the DHCP messages. Untrusted: Configures the port as untrusted source of the DHCP messages.

Snooping Table

This page display the dynamic IP assigned information after DHCP Snooping mode is disabled. All DHCP clients obtained the dynamic IP address from the DHCP server will be listed in this table except for local VLAN interface IP addresses. Entries in the Dynamic DHCP snooping Table are shown on this page.

Dynamic DHCP Snooping Table

Auto-refresh Refresh |<< >>

Start from MAC address , VLAN with entries per page.

MAC Address	VLAN ID	Source Port	IP Address	IP Subnet Mask	DHCP Server
No more entries					

Label	Description
MAC Address	User MAC address of the entry.
VLAN ID	VLAN-ID in which the DHCP traffic is permitted.
Source Port	Switch Port Number for which the entries are displayed.
IP Address	User IP address of the entry.
IP Subnet Mask	User IP subnet mask of the entry.
DHCP Server Address	DHCP Server address of the entry.

Detailed Statistics

This page provides statistics for DHCP snooping. Notice that the normal forward per-port TX statistics isn't increased if the incoming DHCP packet is done by L3 forwarding mechanism. And clear the statistics on specific port may not take effect on global statistics since it gathers the different layer overview.

DHCP Detailed Statistics Port 1			
Combined	Port 1	Auto-refresh <input type="checkbox"/>	Refresh Clear
Receive Packets		Transmit Packets	
Rx Discover	0	Tx Discover	0
Rx Offer	0	Tx Offer	0
Rx Request	0	Tx Request	0
Rx Decline	0	Tx Decline	0
Rx ACK	0	Tx ACK	0
Rx NAK	0	Tx NAK	0
Rx Release	0	Tx Release	0
Rx Inform	0	Tx Inform	0
Rx Lease Query	0	Tx Lease Query	0
Rx Lease Unassigned	0	Tx Lease Unassigned	0
Rx Lease Unknown	0	Tx Lease Unknown	0
Rx Lease Active	0	Tx Lease Active	0
Rx Discarded Checksum Error	0		
Rx Discarded from Untrusted	0		

Label	Description
Rx and Tx Discover	The number of discover (option 53 with value 1) packets received and transmitted.
Rx and Tx Offer	The number of offer (option 53 with value 2) packets received and transmitted.
Rx and Tx Request	The number of request (option 53 with value 3) packets received and transmitted.
Rx and Tx Decline	The number of decline (option 53 with value 4) packets received and transmitted.
Rx and Tx ACK	The number of ACK (option 53 with value 5) packets received and transmitted.
Rx and Tx NAK	The number of NAK (option 53 with value 6) packets received and transmitted.
Rx and Tx Release	The number of release (option 53 with value 7) packets received and transmitted.
Rx and Tx Inform	The number of inform (option 53 with value 8) packets received

	and transmitted.
Rx and Tx Lease Query	The number of lease query (option 53 with value 10) packets received and transmitted.
Rx and Tx Lease Unassigned	The number of lease unassigned (option 53 with value 11) packets received and transmitted.
Rx and Tx Lease Unknown	The number of lease unknown (option 53 with value 12) packets received and transmitted.
Rx and Tx Lease Active	The number of lease active (option 53 with value 13) packets received and transmitted.
Rx Discarded checksum error	The number of discard packet that IP/UDP checksum is error.
Rx Discarded from Untrusted	The number of discarded packet that are coming from untrusted port.

6.3 Port Setting

Port Setting allows you to manage individual ports of the switch, including traffic, power, and trunks.

6.3.1 Port Control

This page shows current port configurations. Ports can also be configured here.

Port Configuration														
Refresh														
Port	Description	Link	Speed		Adv Duplex		Adv speed			Flow Control			PFC	
			Current	Configured	Fdx	Hdx	10M	100M	1G	Enable	Curr Rx	Curr Tx	Enable	Priority
*			<>		<input checked="" type="checkbox"/>	<input checked="" type="checkbox"/>	<input checked="" type="checkbox"/>	<input checked="" type="checkbox"/>	<input checked="" type="checkbox"/>	<input type="checkbox"/>			<input type="checkbox"/>	0-7
1		Down	Auto		<input checked="" type="checkbox"/>	<input checked="" type="checkbox"/>	<input checked="" type="checkbox"/>	<input checked="" type="checkbox"/>	<input checked="" type="checkbox"/>	<input type="checkbox"/>	<input checked="" type="checkbox"/>	<input checked="" type="checkbox"/>	<input type="checkbox"/>	0-7
2		Down	Auto		<input checked="" type="checkbox"/>	<input checked="" type="checkbox"/>	<input checked="" type="checkbox"/>	<input checked="" type="checkbox"/>	<input checked="" type="checkbox"/>	<input type="checkbox"/>	<input checked="" type="checkbox"/>	<input checked="" type="checkbox"/>	<input type="checkbox"/>	0-7
3		Down	Auto		<input checked="" type="checkbox"/>	<input checked="" type="checkbox"/>	<input checked="" type="checkbox"/>	<input checked="" type="checkbox"/>	<input checked="" type="checkbox"/>	<input type="checkbox"/>	<input checked="" type="checkbox"/>	<input checked="" type="checkbox"/>	<input type="checkbox"/>	0-7
4		Down	Auto		<input checked="" type="checkbox"/>	<input checked="" type="checkbox"/>	<input checked="" type="checkbox"/>	<input checked="" type="checkbox"/>	<input checked="" type="checkbox"/>	<input type="checkbox"/>	<input checked="" type="checkbox"/>	<input checked="" type="checkbox"/>	<input type="checkbox"/>	0-7
5		Down	Auto		<input checked="" type="checkbox"/>	<input checked="" type="checkbox"/>	<input checked="" type="checkbox"/>	<input checked="" type="checkbox"/>	<input checked="" type="checkbox"/>	<input type="checkbox"/>	<input checked="" type="checkbox"/>	<input checked="" type="checkbox"/>	<input type="checkbox"/>	0-7

Label	Description
Port	This is the logical port number for this row.
Description	The description of the port. It is an ASCII string no longer than 256 characters.
Link	The current link state is displayed graphically. Green indicates the link is up and red that it is down.
Current Link Speed	Provides the current link speed of the port.

<p>Configured Link Speed</p>	<p>Selects any available link speed for the given switch port. Only speeds supported by the specific port are shown. Possible speeds are:</p> <p>Disabled - Disables the switch port operation.</p> <p>Auto - Port auto negotiating speed with the link partner and selects the highest speed that is compatible with the link partner.</p> <p>10Mbps HDX - Forces the cu port in 10Mbps half duplex mode.</p> <p>10Mbps FDX - Forces the cu port in 10Mbps full duplex mode.</p> <p>100Mbps HDX - Forces the cu port in 100Mbps half duplex mode.</p> <p>100Mbps FDX - Forces the cu port in 100Mbps full duplex mode.</p> <p>1Gbps FDX - Forces the port in 1Gbps full duplex</p> <p>2.5Gbps FDX - Forces the Serdes port in 2.5Gbps full duplex mode.</p> <p>SFP_Auto_AMS - Automatically determines the speed of the SFP. Note: There is no standardized way to do SFP auto detect, so here it is done by reading the SFP rom. Due to the missing standardized way of doing SFP auto detect some SFPs might not be detectable. The port is set in <u>AMS</u> mode. Cu port is set in Auto mode.</p> <p>100-FX - SFP port in 100-FX speed. Cu port disabled.</p> <p>1000-X - SFP port in 1000-X speed. Cu port disabled. Ports in AMS mode with 1000-X speed have Cu port preferred.</p> <p>Ports in AMS mode with 1000-X speed have fiber port preferred.</p> <p>Ports in AMS mode with 100-FX speed have fiber port preferred.</p>
<p>Advertise Duplex</p>	<p>When duplex is set as auto i.e auto negotiation, the port will only advertise the specified duplex as either Fdx or Hdxto the link partner. By default port will advertise all the supported duplexes if the Duplex</p>

	is Auto.
Advertise Speed	When Speed is set as auto i.e auto negotiation, the port will only advertise the specified speeds (10M 100M 1G) to the link partner. By default port will advertise all the supported speeds if speed is set as Auto.
Flow Control	<p>When Auto Speed is selected on a port, this section indicates the flow control capability that is advertised to the link partner.</p> <p>When a fixed-speed setting is selected, that is what is used. The Current Rx column indicates whether pause frames on the port are obeyed, and the Current Tx column indicates whether pause frames on the port are transmitted. The Rx and Tx settings are determined by the result of the last <u>Auto Negotiation</u>. Check the configured column to use flow control. This setting is related to the setting for Configured Link Speed.</p> <p>NOTICE: The 100FX standard doesn't support Auto Negotiation, so when in 100FX mode the flow control capabilities will always be shown as "disabled".</p>
PFC	When PFC (802.1Qbb Priority Flow Control) is enabled on a port then flow control on a priority level is enabled. Through the Priority field, range (one or more) of priorities can be configured, e.g. '0-3,7' which equals '0,1,2,3,7'. PFC is not supported through auto negotiation. PFC and Flow control cannot both be enabled on the same port.
Maximum Frame Size	Enter the maximum frame size allowed for the switch port, including FCS. The range is 1518-10240 bytes.
Excessive Collision Mode	<p>Configure port transmit collision behavior.</p> <p>Discard: Discard frame after 16 collisions (default).</p> <p>Restart: Restart backoff algorithm after 16 collisions.</p>
Frame Length Check	Configures if frames with incorrect frame length in the EtherType/Length field shall be dropped. An Ethernet frame contains a field EtherType which can be used to indicate the frame payload size (in bytes) for values of

	1535 and below. If the EtherType/Length field is above 1535, it indicates that the field is used as an EtherType (indicating which protocol is encapsulated in the payload of the frame). If "frame length check" is enabled, frames with payload size less than 1536 bytes are dropped, if the EtherType/Length field doesn't match the actually payload length. If "frame length check" is disabled, frames are not dropped due to frame length mismatch. Note: No drop counters count frames dropped due to frame length mismatch
--	--

6.3.2 Port Trunk

A port trunk is a group of ports that have been grouped together to function as one logical path. This method provides an economical way for you to increase the bandwidth between the switch and another networking device. In addition, it is useful when a single physical link between the devices is insufficient to handle the traffic load. This page allows you to configure the aggregation hash mode and the aggregation group.

Configurations

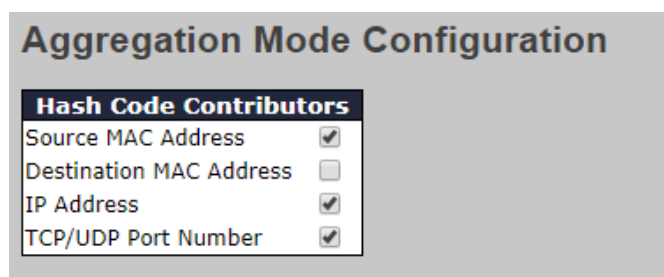

Label	Description
Source MAC Address	Calculates the destination port of the frame. You can check this box to enable the source MAC address, or uncheck to disable. By default, Source MAC Address is enabled.
Destination MAC Address	Calculates the destination port of the frame. You can check this box to enable the destination MAC address, or uncheck to disable. By default, Destination MAC Address is disabled.
IP Address	Calculates the destination port of the frame. You can check this box to enable the IP address, or uncheck to disable. By default, IP Address is enabled.

TCP/UDP Number	Port	Calculates the destination port of the frame. You can check this box to enable the TCP/UDP port number, or uncheck to disable. By default, TCP/UDP Port Number is enabled.
-----------------------	-------------	---

Aggregation Group Configuration																				
Group ID	Port Members																			
	1	2	3	4	5	6	7	8	9	10	11	12	13	14	15	16	17	18	19	20
Normal	<input checked="" type="radio"/>	<input checked="" type="radio"/>	<input checked="" type="radio"/>	<input checked="" type="radio"/>	<input checked="" type="radio"/>	<input checked="" type="radio"/>	<input checked="" type="radio"/>	<input checked="" type="radio"/>	<input checked="" type="radio"/>	<input checked="" type="radio"/>	<input checked="" type="radio"/>	<input checked="" type="radio"/>	<input checked="" type="radio"/>	<input checked="" type="radio"/>	<input checked="" type="radio"/>	<input checked="" type="radio"/>	<input checked="" type="radio"/>	<input checked="" type="radio"/>	<input checked="" type="radio"/>	<input checked="" type="radio"/>
1	<input type="radio"/>	<input type="radio"/>	<input type="radio"/>	<input type="radio"/>	<input type="radio"/>	<input type="radio"/>	<input type="radio"/>	<input type="radio"/>	<input type="radio"/>	<input type="radio"/>	<input type="radio"/>	<input type="radio"/>	<input type="radio"/>	<input type="radio"/>	<input type="radio"/>	<input type="radio"/>	<input type="radio"/>	<input type="radio"/>	<input type="radio"/>	<input type="radio"/>
2	<input type="radio"/>	<input type="radio"/>	<input type="radio"/>	<input type="radio"/>	<input type="radio"/>	<input type="radio"/>	<input type="radio"/>	<input type="radio"/>	<input type="radio"/>	<input type="radio"/>	<input type="radio"/>	<input type="radio"/>	<input type="radio"/>	<input type="radio"/>	<input type="radio"/>	<input type="radio"/>	<input type="radio"/>	<input type="radio"/>	<input type="radio"/>	<input type="radio"/>
3	<input type="radio"/>	<input type="radio"/>	<input type="radio"/>	<input type="radio"/>	<input type="radio"/>	<input type="radio"/>	<input type="radio"/>	<input type="radio"/>	<input type="radio"/>	<input type="radio"/>	<input type="radio"/>	<input type="radio"/>	<input type="radio"/>	<input type="radio"/>	<input type="radio"/>	<input type="radio"/>	<input type="radio"/>	<input type="radio"/>	<input type="radio"/>	<input type="radio"/>

Label	Description
Group ID	Indicates the ID of each aggregation group. Normal means no aggregation. Only one group ID is valid per port.
Port Members	Lists each switch port for each group ID. Select a radio button to include a port in an aggregation, or clear the radio button to remove the port from the aggregation. By default, no ports belong to any aggregation group. Only full duplex ports can join an aggregation and the ports must be in the same speed in each group.

LACP

LACP (Link Aggregation Control Protocol) trunks are similar to static port trunks, but they are more flexible because LACP is compliant with the IEEE 802.3ad standard. Hence, it is interoperable with equipment from other vendors that also comply with the standard. This page allows you to enable LACP functions to group ports together to form single virtual links and change associated settings, thereby increasing the bandwidth between the switch and other LACP-compatible devices.

LACP Port Configuration

Port	LACP Enabled	Key	Role	Timeout	Prio
*	<input type="checkbox"/>	<> ▼	<> ▼	<> ▼	32768
1	<input type="checkbox"/>	Auto ▼	Active ▼	Fast ▼	32768
2	<input type="checkbox"/>	Auto ▼	Active ▼	Fast ▼	32768
3	<input type="checkbox"/>	Auto ▼	Active ▼	Fast ▼	32768
4	<input type="checkbox"/>	Auto ▼	Active ▼	Fast ▼	32768
5	<input type="checkbox"/>	Auto ▼	Active ▼	Fast ▼	32768
6	<input type="checkbox"/>	Auto ▼	Active ▼	Fast ▼	32768
7	<input type="checkbox"/>	Auto ▼	Active ▼	Fast ▼	32768

Label	Description
Port	Indicates the ID of each aggregation group. Normal indicates there is no aggregation. Only one group ID is valid per port.
LACP Enabled	Lists each switch port for each group ID. Check to include a port in an aggregation, or clear the box to remove the port from the aggregation. By default, no ports belong to any aggregation group. Only full duplex ports can join an aggregation and the ports must be in the same speed in each group.
Key	The Key value varies with the port, ranging from 1 to 65535. Auto will set the key according to the physical link speed (10Mb = 1, 100Mb = 2, 1Gb = 3). Specific allows you to enter a user-defined value. Ports with the same key value can join in the same aggregation group, while ports with different keys cannot.
Role	Indicates LACP activity status. Active will transmit LACP packets every second, while Passive will wait for a LACP packet from a partner (speak if spoken to).
Timeout	The Timeout controls the period between BPDU transmissions. Fast will transmit LACP packets each second, while Slow will wait for 30 seconds before sending a LACP packet.
Prio	The Prio controls the priority of the port, range 1-65535. If the LACP partner wants to form a larger group than is supported

	by this device then this parameter will control which ports will be active and which ports will be in a backup role. Lower number means greater priority.
--	---

LACP System Status

This page provides a status overview for all LACP instances.

LACP System Status

Auto-refresh Refresh

Aggr ID	Partner System ID	Partner Key	Partner Prio	Last Changed	Local Ports
No ports enabled or no existing partners					

Label	Description
Aggr ID	The aggregation ID is associated with the aggregation instance. For LLAG, the ID is shown as ' isid:aggr-id ' and for GLAGs as ' aggr-id '
Partner System ID	System ID (MAC address) of the aggregation partner
Partner Key	When connecting the device to other manufactures' devices, you may need to configure LACP partner key. Partner key is the operational key value assigned to the port associated with this link by the Partner.
Last Changed	The time since this aggregation is changed.
Local Ports	Indicates which ports belong to the aggregation of the switch/stack. The format is: " Switch ID:Port ".
Refresh	Click to refresh the page immediately
Auto-refresh	Check to enable an automatic refresh of the page at regular intervals

LACP Port Status

This page provides an overview of the LACP status for all ports.

LACP Status

Auto-refresh Refresh

Port	LACP	Key	Aggr ID	Partner System ID	Partner Port	Partner Prio
1	No	-	-	-	-	-
2	No	-	-	-	-	-
3	No	-	-	-	-	-
4	No	-	-	-	-	-
5	No	-	-	-	-	-
6	No	-	-	-	-	-
7	No	-	-	-	-	-

Label	Description
Port	Switch port number
LACP	Yes means LACP is enabled and the port link is up. No means LACP is not enabled or the port link is down. Backup means the port cannot join in the aggregation group unless other ports are removed. The LACP status is disabled.
Key	The key assigned to the port. Only ports with the same key can be aggregated
Aggr ID	The aggregation ID assigned to the aggregation group
Partner System ID	The partner's system ID (MAC address)
Partner Port	The partner's port number associated with the port
Partner Prio	The partner's port priority.
Refresh	Click to refresh the page immediately
Auto-refresh	Check to enable an automatic refresh of the page at regular intervals

LACP Port Statistics

This page provides an overview of the LACP statistics for all ports.

LACP Statistics					
Auto-refresh <input type="checkbox"/> Refresh Clear					
Port	LACP Received	LACP Transmitted	Discarded		
			Unknown	Illegal	
1	0	0	0	0	0
2	0	0	0	0	0
3	0	0	0	0	0
4	0	0	0	0	0
5	0	0	0	0	0
6	0	0	0	0	0
7	0	0	0	0	0
8	0	0	0	0	0

Label	Description
Port	Switch port number
LACP Transmitted	The number of LACP frames sent from each port
LACP Received	The number of LACP frames received at each port
Discarded	The number of unknown or illegal LACP frames discarded at each port.
Refresh	Click to refresh the page immediately
Auto-refresh	Check to enable an automatic refresh of the page at regular intervals
Clear	Click to clear the counters for all ports

6.3.3 Loop Protection

This feature prevents loop attack. When receiving loop packets, the port will be disabled automatically, preventing the loop attack from affecting other network devices.

Configuration

Loop Protection Configuration		
General Settings		
Global Configuration		
Enable Loop Protection	Disable ▼	
Transmission Time	5	seconds
Shutdown Time	180	seconds

Label	Description
Enable Loop Protection	Activate loop protection functions (as a whole)
Transmission Time	The interval between each loop protection PDU sent on each port. The valid value is 1 to 10 seconds.
Shutdown Time	The period (in seconds) for which a port will be kept disabled when a loop is detected (shutting down the port). The valid value is 0 to 604800 seconds (7 days). A value of zero will keep a port disabled permanently (until the device is restarted).

Port	Enable	Action	Tx Mode
*	<input checked="" type="checkbox"/>	<>	<>
1	<input checked="" type="checkbox"/>	Shutdown Port	Enable
2	<input checked="" type="checkbox"/>	Shutdown Port	Enable
3	<input checked="" type="checkbox"/>	Shutdown Port	Enable
4	<input checked="" type="checkbox"/>	Shutdown Port	Enable

Label	Description
Port	Switch port number
Enable	Activate loop protection functions (as a whole)
Action	Configures the action to take when a loop is detected. Valid values include Shutdown Port , Shutdown Port , and Log or Log Only .
Tx Mode	Controls whether the port is actively generating loop protection PDUs or only passively look for looped PDUs.

6.4 VLAN

6.4.1 VLAN Membership

A VLAN is a group of end devices with a common set of requirements, independent of physical location. With the same attributes as a physical LAN, VLANs enable you to group end devices even if they are not located physically on the same LAN segment. By splitting up a network into sets of VLANs, assigning ports to individual VLANs, and defining criteria for VLAN membership for workstations connected to those ports, traffic for the same VLAN can be sent between switches.

Global VLAN Configuration

Global VLAN Configuration

Allowed Access VLANs	1
Ethertype for Custom S-ports	88A8

Label	Description
Allowed Access VLANs	<p>This field shows the allowed Access VLANs, i.e. it only affects ports configured as <u>Access ports</u>. Ports in other modes are members of the VLANs specified in the <u>Allowed VLANs</u> field. By default, only VLAN 1 is enabled. More VLANs may be created by using a list syntax where the individual elements are separated by commas. Ranges are specified with a dash separating the lower and upper bound.</p> <p>The following example will create VLANs 1, 10, 11, 12, 13, 200, and 300: 1,10-13,200,300. Spaces are allowed in between the delimiters.</p>
Ethertype for Custom S-ports	<p>This field specifies the ethertype/TPID (specified in hexadecimal) used for Custom S-ports. The setting is in force for all ports whose <u>Port Type</u> is set to S-Custom-Port.</p>

Port VLAN Configuration

Port VLAN Configuration								
Port	Mode	Port VLAN	Port Type	Ingress Filtering	Ingress Acceptance	Egress Tagging	Allowed VLANs	Forbidden VLANs
*	<>	1	<>	<input checked="" type="checkbox"/>	<>	<>	1	
1	Access	1	C-Port	<input checked="" type="checkbox"/>	Tagged and Untagged	Untag All	1	
2	Access	1	C-Port	<input checked="" type="checkbox"/>	Tagged and Untagged	Untag All	1	
3	Access	1	C-Port	<input checked="" type="checkbox"/>	Tagged and Untagged	Untag All	1	
4	Access	1	C-Port	<input checked="" type="checkbox"/>	Tagged and Untagged	Untag All	1	
5	Access	1	C-Port	<input checked="" type="checkbox"/>	Tagged and Untagged	Untag All	1	

Label	Description
Port	This is the logical port number of this row.
Mode	<p>The port mode (default is Access) determines the fundamental behavior of the port in question. A port can be in one of three modes as described below.</p> <p>Whenever a particular mode is selected, the remaining fields in that row will be either grayed out or made changeable depending on the mode in question.</p> <p>Grayed out fields show the value that the port will get when the mode is applied.</p> <p><u>Access:</u></p> <p>Access ports are normally used to connect to end stations. Dynamic features like Voice VLAN may add the port to more VLANs behind the scenes. Access ports have the following characteristics:</p> <ul style="list-style-type: none"> • Member of exactly one VLAN, the Port VLAN (a.k.a. Access VLAN), which by default is 1 • Accepts untagged and C-tagged frames • Discards all frames not classified to the Access VLAN • On egress all frames are transmitted untagged <p><u>Trunk:</u></p> <p>Trunk ports can carry traffic on multiple VLANs simultaneously, and are normally used to connect to other switches. Trunk ports have the following characteristics:</p> <ul style="list-style-type: none"> • By default, a trunk port is member of all VLANs (1-4095) • The VLANs that a trunk port is member of may be limited by the use of <u>Allowed VLANs</u>

	<ul style="list-style-type: none"> • Frames classified to a VLAN that the port is not a member of are discarded • By default, all frames but frames classified to the Port VLAN (a.k.a. Native VLAN) get tagged on egress. Frames classified to the Port VLAN do not get C-tagged on egress • Egress tagging can be changed to tag all frames, in which case only tagged frames are accepted on ingress <p>Hybrid: Hybrid ports resemble trunk ports in many ways, but adds additional port configuration features. In addition to the characteristics described for trunk ports, hybrid ports have these abilities:</p> <ul style="list-style-type: none"> • Can be configured to be VLAN tag unaware, C-tag aware, S-tag aware, or S-custom-tag aware • Ingress filtering can be controlled • Ingress acceptance of frames and configuration of egress tagging can be configured independently
Port VLAN	<p>Determines the port's VLAN ID (a.k.a. PVID). Allowed VLANs are in the range 1 through 4095, default being 1.</p> <p>On ingress, frames get classified to the Port VLAN if the port is configured as VLAN unaware, the frame is untagged, or VLAN awareness is enabled on the port, but the frame is priority tagged (VLAN ID = 0).</p> <p>On egress, frames classified to the Port VLAN do not get tagged if <u>Egress Tagging</u> configuration is set to untag Port VLAN.</p> <p>The Port VLAN is called an "Access VLAN" for ports in Access mode and Native VLAN for ports in Trunk or Hybrid mode.</p>
Port Type	<p>Ports in hybrid mode allow for changing the port type, that is, whether a frame's VLAN tag is used to classify the frame on ingress to a particular VLAN, and if so, which TPID it reacts on. Likewise, on egress, the Port Type determines the TPID of the tag, if a tag is required.</p>

	<p><u>Unaware:</u></p> <p>On ingress, all frames, whether carrying a VLAN tag or not, get classified to the Port VLAN, and possible tags are not removed on egress.</p> <p><u>C-Port:</u></p> <p>On ingress, frames with a VLAN tag with TPID = 0x8100 get classified to the VLAN ID embedded in the tag.</p> <p>If a frame is untagged or priority tagged, the frame gets classified to the Port VLAN.</p> <p>If frames must be tagged on egress, they will be tagged with a C-tag.</p> <p><u>S-Port:</u></p> <p>On ingress, frames with a VLAN tag with TPID = 0x88A8 get classified to the VLAN ID embedded in the tag.</p> <p>Priority-tagged frames are classified to the Port VLAN.</p> <p>If the port is configured to accept Tagged Only frames (see <u>Ingress Acceptance</u> below), frames without this TPID are dropped.</p> <p>If frames must be tagged on egress, they will be tagged with an S-tag.</p> <p><u>S-Custom-Port:</u></p> <p>On ingress, frames with a VLAN tag with a TPID equal to the <u>Ethertype configured for Custom-S ports</u> get classified to the VLAN ID embedded in the tag.</p> <p>Priority-tagged frames are classified to the Port VLAN.</p> <p>If the port is configured to accept Tagged Only frames (see <u>Ingress Acceptance</u> below), frames without this TPID are dropped.</p> <p>If frames must be tagged on egress, they will be tagged with the custom S-tag.</p>
Ingress Filtering	<p>Hybrid ports allow for changing ingress filtering. Access and Trunk ports always have ingress filtering enabled.</p> <p>If ingress filtering is enabled (checkbox is checked), frames classified to a VLAN that the port is not a member of get discarded.</p> <p>If ingress filtering is disabled, frames classified to a VLAN that the port is not a member of are accepted and forwarded to the</p>

	switch engine. However, the port will never transmit frames classified to VLANs that it is not a member of.
Ingress Acceptance	<p>Hybrid ports allow for changing the type of frames that are accepted on ingress.</p> <p><u>Tagged and Untagged</u> Both tagged and untagged frames are accepted. See <u>Port Type</u> for a description of when a frame is considered tagged.</p> <p><u>Tagged Only</u> Only frames tagged with the corresponding <u>Port Type</u> tag are accepted on ingress.</p> <p><u>Untagged Only</u> Only untagged frames are accepted on ingress. See <u>Port Type</u> for a description of when a frame is considered untagged.</p>
Egress Tagging	<p>Ports in Trunk and Hybrid mode may control the tagging of frames on egress.</p> <p><u>Untag Port VLAN</u> Frames classified to the Port VLAN are transmitted untagged. Other frames are transmitted with the relevant tag.</p> <p><u>Tag All</u> All frames, whether classified to the Port VLAN or not, are transmitted with a tag.</p> <p><u>Untag All</u> All frames, whether classified to the Port VLAN or not, are transmitted without a tag.</p> <p>This option is only available for ports in Hybrid mode.</p>
Allowed VLANs	<p>Ports in Trunk and Hybrid mode may control which VLANs they are allowed to become members of. Access ports can only be member of one VLAN, the Access VLAN.</p> <p>The field's syntax is identical to the syntax used in the <u>Enabled VLANs</u> field. By default, a Trunk or Hybrid port will become member of all VLANs, and is therefore set to 1-4095.</p> <p>The field may be left empty, which means that the port will not become member of any VLANs</p>
Forbidden VLANs	<p>A port may be configured to never become member of one or more VLANs. This is particularly useful when dynamic VLAN protocols like MVRP and GVRP must be prevented from dynamically adding ports to VLANs.</p>

	<p>The trick is to mark such VLANs as forbidden on the port in question. The syntax is identical to the syntax used in the <u>Enabled VLANs</u> field.</p> <p>By default, the field is left blank, which means that the port may become a member of all possible VLANs.</p>
--	---

6.4.2 Membership Status

This page provides an overview of membership status of VLAN users.

VLAN Membership Status for Combined users

Combined ▼
Auto-refresh
Refresh

Start from VLAN with entries per page.
 |<<
>>

Port Members																					
VLAN ID	1	2	3	4	5	6	7	8	9	10	11	12	13	14	15	16	17	18	19	20	
1	✓	✓	✓	✓	✓	✓	✓	✓	✓	✓	✓	✓	✓	✓	✓	✓	✓	✓	✓	✓	✓

Label	Description
VLAN User	<p>Various internal software modules may use VLAN services to configure VLAN memberships on the fly.</p> <p>The drop-down list on the right allows for selecting between showing VLAN memberships as configured by an administrator (Admin) or as configured by one of these internal software modules.</p> <p>The "Combined" entry will show a combination of the administrator and internal software modules configuration, and basically reflects what is actually configured in hardware</p>
VLAN ID	VLAN ID for which the Port members are displayed.
Port Members	<p>A row of check boxes for each port is displayed for each VLAN ID.</p> <p>If a port is included in a VLAN, the following image will be displayed: ✓.</p> <p>If a port is in the forbidden port list, the following image will be displayed: ✗.</p> <p>If a port is in the forbidden port list and at the same time attempted included in the VLAN, the following image will be displayed: ✗. The port will not be a member of the VLAN in this case.</p>

6.4.3 Port Status

This page provides VLAN Port Status

VLAN Port Status for Combined users							
Combined ▾		Auto-refresh <input type="checkbox"/>	Refresh				
Port	Port Type	Ingress Filtering	Frame Type	Port VLAN ID	Tx Tag	Untagged VLAN ID	Conflicts
1	C-Port	<input checked="" type="checkbox"/>	All	1	Untag All		No
2	C-Port	<input checked="" type="checkbox"/>	All	1	Untag All		No
3	C-Port	<input checked="" type="checkbox"/>	All	1	Untag All		No
4	C-Port	<input checked="" type="checkbox"/>	All	1	Untag All		No
5	C-Port	<input checked="" type="checkbox"/>	All	1	Untag All		No

Label	Description
VLAN User	<p>Various internal software modules may use VLAN services to configure VLAN port configuration on the fly.</p> <p>The drop-down list on the right allows for selecting between showing VLAN memberships as configured by an administrator (Admin) or as configured by one of these internal software modules.</p> <p>The "Combined" entry will show a combination of the administrator and internal software modules configuration, and basically reflects what is actually configured in hardware.</p> <p>If a given software modules hasn't overridden any of the port settings, the text "No data exists for the selected user" is shown in the table.</p>
Port	The logical port for the settings contained in the same row.
Port Type	<p>Shows the port type (Unaware, C-Port, S-Port, S-Custom-Port.) that a given user wants to configure on the port.</p> <p>The field is empty if not overridden by the selected user.</p>
Ingress Filtering	<p>Shows whether a given user wants ingress filtering enabled or not.</p> <p>The field is empty if not overridden by the selected user.</p>
Frame Type	<p>Shows the acceptable frame types (All, Taged, Untagged) that a given user wants to configure on the port.</p> <p>The field is empty if not overridden by the selected user.</p>
Port VLAN ID	Shows the Port VLAN ID (PVID) that a given user wants the

	<p>port to have.</p> <p>The field is empty if not overridden by the selected user.</p>
Tx Tag	<p>Shows the Tx Tag requirements (Tag All, Tag PVID, Tag UVID, Untag All, Untag PVID, Untag UVID) that a given user has on a port.</p> <p>The field is empty if not overridden by the selected user.</p>
Untagged VLAN ID	<p>If Tx Tag is overridden by the selected user and is set to Tag or Untag UVID, then this field will show the VLAN ID the user wants to tag or untag on egress.</p> <p>The field is empty if not overridden by the selected user.</p>
Conflicts	<p>Two users may have conflicting requirements to a port's configuration. For instance, one user may require all frames to be tagged on egress while another requires all frames to be untagged on egress.</p> <p>Since both users cannot win, this gives rise to a conflict, which is solved in a prioritized way. The Administrator has the least priority. Other software modules are prioritized according to their position in the drop-down list: The higher in the list, the higher priority.</p> <p>If conflicts exist, it will be displayed as "Yes" for the "Combined" user and the offending software module.</p> <p>The "Combined" user reflects what is actually configured in hardware.</p>

6.4.4 Private VLAN

The private VLAN membership configuration for the switch can be monitored and modified here. Private VLANs can be added or deleted here. Port members of each private VLAN can be added or removed here. Private VLANs are based on the source port mask, and there are no connections to VLANs. This means that VLAN IDs and private VLAN IDs can be identical.

A port must be a member of both a VLAN and a private VLAN to be able to forward packets. By default, all ports are VLAN unaware and members of VLAN 1 and private VLAN 1.

A VLAN-unaware port can only be a member of one VLAN, but it can be a member of multiple private VLANs.

Private VLAN Membership Configuration

		Port Members																			
Delete	PVLAN ID	1	2	3	4	5	6	7	8	9	10	11	12	13	14	15	16	17	18	19	20
<input type="checkbox"/>	1	<input checked="" type="checkbox"/>	<input checked="" type="checkbox"/>	<input checked="" type="checkbox"/>	<input checked="" type="checkbox"/>	<input checked="" type="checkbox"/>	<input checked="" type="checkbox"/>	<input checked="" type="checkbox"/>	<input checked="" type="checkbox"/>	<input checked="" type="checkbox"/>	<input checked="" type="checkbox"/>	<input checked="" type="checkbox"/>	<input checked="" type="checkbox"/>	<input checked="" type="checkbox"/>	<input checked="" type="checkbox"/>	<input checked="" type="checkbox"/>	<input checked="" type="checkbox"/>	<input checked="" type="checkbox"/>	<input checked="" type="checkbox"/>	<input checked="" type="checkbox"/>	<input checked="" type="checkbox"/>
Add New Private VLAN																					
Save Reset																					

Label	Description
Delete	Check to delete the entry. It will be deleted during the next save.
Private VLAN ID	Indicates the ID of this particular private VLAN.
MAC Address	The MAC address for the entry.
Port Members	A row of check boxes for each port is displayed for each private VLAN ID. You can check the box to include a port in a private VLAN. To remove or exclude the port from the private VLAN, make sure the box is unchecked. By default, no ports are members, and all boxes are unchecked.
Adding a New Static Entry	Click Add New Private VLAN to add a new private VLAN ID. An empty row is added to the table, and the private VLAN can be configured as needed. The allowed range for a private VLAN ID is the same as the switch port number range. Any values outside this range are not accepted, and a warning message appears. Click OK to discard the incorrect entry, or click Cancel to return to the editing and make a correction. The private VLAN is enabled when you click Save. The Delete button can be used to undo the addition of new private VLANs.

Port Isolation Configuration

Port Number																			
1	2	3	4	5	6	7	8	9	10	11	12	13	14	15	16	17	18	19	20
<input type="checkbox"/>	<input type="checkbox"/>	<input type="checkbox"/>	<input type="checkbox"/>	<input type="checkbox"/>	<input type="checkbox"/>	<input type="checkbox"/>	<input type="checkbox"/>	<input type="checkbox"/>	<input type="checkbox"/>	<input type="checkbox"/>	<input type="checkbox"/>	<input type="checkbox"/>	<input type="checkbox"/>	<input type="checkbox"/>	<input type="checkbox"/>	<input type="checkbox"/>	<input type="checkbox"/>	<input type="checkbox"/>	<input type="checkbox"/>
Save Reset																			

Label	Description
Port Members	A check box is provided for each port of a private VLAN. When checked, port isolation is enabled for that port. When unchecked, port isolation is disabled for that port. By default, port isolation is disabled for all ports.

6.4.5 GVRP

GVRP is an acronym for **G**ARP **V**LAN **R**egistration **P**rotocol. It is a protocol for dynamically registering VLANs on ports, and is specified in IEEE 802.1Q-2005, clause 11. GVRP is an example of the use of GARP, hence the G in GVRP.

GVRP Config

This page allows you to configure the global **GVRP** configuration settings that are commonly applied to all GVRP enabled ports.

GVRP Configuration

Enable GVRP

Parameter	Value
Join-time:	20
Leave-time:	60
LeaveAll-time:	1000
Max VLANs:	20

Label	Description
Enable VRRP Globally	The GVRP feature is globally enabled by setting the check mark in the checkbox named Enable GVRP and pressing the Save button.
GVRP Protocol Timers	Join-time is a value in the range of 1-20cs, i.e. in units of one hundredth of a second. The default value is 20cs. Leave-time is a value in the range of 60-300cs, i.e. in units of one hundredth of a second. The default is 60cs. LeaveAll-time is a value in the range of 1000-5000cs, i.e. in

	units of one hundredth of a second. The default is 1000cs.
Max number of VLANs	When GVRP is enabled, a maximum number of VLANs supported by GVRP is specified. By default this number is 20. This number can only be changed when GVRP is turned off.

Port Config

This page allows you to enable or disable a port for GVRP operation. This configuration can be performed either before or after GVRP is configured globally - the protocol operation will be the same.

GVRP Port Configuration

Port	Mode
*	<> ▼
1	Disabled ▼
2	Disabled ▼
3	Disabled ▼
4	Disabled ▼
5	Disabled ▼
6	Disabled ▼

Label	Description
Port	The logical port that is to be configured.
Mode	Mode can be either 'Disabled' or 'GVRP enabled'. These values turn the GVRP feature off or on respectively for the port in question.

6.5 SNMP

6.5.1 SNMP System Configurations

SNMP System Configuration

Mode	Enabled ▼
Version	SNMP v2c ▼
Read Community	public
Write Community	private
Engine ID	800007e5017f000001

Label	Description
Mode	Indicates existing SNMP mode. Possible modes include: Enabled: enable SNMP mode Disabled: disable SNMP mode
Version	Indicates the supported SNMP version. Possible versions include: SNMP v1: supports SNMP version 1. SNMP v2c: supports SNMP version 2c. SNMP v3: supports SNMP version 3.
Read Community	Indicates the read community string to permit access to SNMP agent. The allowed string length is 0 to 255, and only ASCII characters from 33 to 126 are allowed. The field only suits to SNMPv1 and SNMPv2c. SNMPv3 uses USM for authentication and privacy and the community string will be associated with SNMPv3 community table.
Write Community	Indicates the write community string to permit access to SNMP agent. The allowed string length is 0 to 255, and only ASCII characters from 33 to 126 are allowed. The field only suits to SNMPv1 and SNMPv2c. SNMPv3 uses USM for authentication and privacy and the community string will be associated with SNMPv3 community table.
Engine ID	Indicates the SNMPv3 engine ID. The string must contain an even number between 10 and 64 hexadecimal digits, but all-zeros and all-'F's are not allowed. Change of the Engine ID will clear all original local users.

6.5.2 Trap

SNMP Trap Detailed Configuration

Trap Config Name	<input type="text"/>
Trap Mode	Disabled ▼
Trap Version	SNMP v2c ▼
Trap Community	Public
Trap Destination Address	<input type="text"/>
Trap Destination Port	162
Trap Inform Mode	Disabled ▼
Trap Inform Timeout (seconds)	3
Trap Inform Retry Times	5
Trap Probe Security Engine ID	Enabled ▼
Trap Security Engine ID	<input type="text"/>
Trap Security Name	None ▼

Label	Description
Trap Config Name	Indicates which trap Configuration's name for configuring. The allowed string length is 1 to 32, and the allowed content is ASCII characters from 33 to 126.
Trap Mode	Indicates existing SNMP trap mode. Possible modes include: Enabled: enable SNMP trap mode Disabled: disable SNMP trap mode
Trap Version	Indicates the supported SNMP trap version. Possible versions include: SNMP v1: supports SNMP trap version 1 SNMP v2c: supports SNMP trap version 2c SNMP v3: supports SNMP trap version 3
Trap Community	Indicates the community access string when sending SNMP trap packets. The allowed string length is 0 to 255, and only ASCII characters from 33 to 126 are allowed.
Trap Destination Address	Indicates the SNMP trap destination address. It allow a valid IP address in dotted decimal notation ('x.y.z.w'). And it also allows a valid hostname. A valid hostname is a string drawn from the alphabet (A-Za-z), digits (0-9), dot (.), dash (-). Spaces are not allowed, the first character must be an alpha character, and the first and last characters must not be a dot or a

	dash. Indicates the SNMP trap destination IPv6 address. IPv6 address is in 128-bit records represented as eight fields of up to four hexadecimal digits with a colon separating each field (:). For example, 'fe80::215:c5ff:fe03:4dc7'. The symbol '::' is a special syntax that can be used as a shorthand way of representing multiple 16-bit groups of contiguous zeros; but it can appear only once. It can also represent a legally valid IPv4 address. For example, '::192.1.2.34'.
Trap Destination Port	Indicates the SNMP trap destination port. SNMP Agent will send SNMP message via this port, the port range is 1~65535.
Trap Inform Mode	Indicates the SNMP trap inform mode. Possible modes include: Enabled: enable SNMP trap inform mode Disabled: disable SNMP trap inform mode
Trap Inform Timeout(seconds)	Configures the SNMP trap inform timeout. The allowed range is 0 to 2147.
Trap Inform Retry Times	Configures the retry times for SNMP trap inform. The allowed range is 0 to 255.
Trap Probe Securty Engine ID	Indicates the SNMP trap probe security engine ID mode of operation. Possible values are: Enabled: Enable SNMP trap probe security engine ID mode of operation. Disabled: Disable SNMP trap probe security engine ID mode of operation.
Trap Security Engine ID	Indicates the SNMP trap security engine ID. SNMPv3 sends traps and informs using USM for authentication and privacy. A unique engine ID for these traps and informs is needed. When "Trap Probe Security Engine ID" is enabled, the ID will be probed automatically. Otherwise, the ID specified in this field is used. The string must contain an even number (in hexadecimal format) with number of digits between 10 and 64, but all-zeros and all-'F's are not allowed.
Trap Security Name	Indicates the SNMP trap security name. SNMPv3 traps and informs using USM for authentication and privacy. A unique security name is needed when traps and informs are enabled.

SNMP Trap Event

SNMP Trap Event

System	<input type="checkbox"/> * <input type="checkbox"/> Warm Start <input type="checkbox"/> Cold Start
Interface	Link up <input checked="" type="radio"/> none <input type="radio"/> specific <input type="radio"/> all switches <input type="checkbox"/> * Link down <input checked="" type="radio"/> none <input type="radio"/> specific <input type="radio"/> all switches LLDP <input checked="" type="radio"/> none <input type="radio"/> specific <input type="radio"/> all switches
Authentication	<input type="checkbox"/> * <input type="checkbox"/> SNMP Authentication Fail
Switch	<input type="checkbox"/> * <input type="checkbox"/> STP <input type="checkbox"/> RMON

Label	Description
System	Enable/disable that the Interface group's traps. Possible traps are: Warm Start: Enable/disable Warm Start trap. Cold Start: Enable/disable Cold Start trap.
Interface	Indicates that the Interface group's traps. Possible traps are: Indicates that the SNMP entity is permitted to generate authentication failure traps. Possible modes are: Link Up: Enable/disable Link up trap. Link Down: Enable/disable Link down trap. LLDP: Enable/disable LLDP trap.
Authentication	Indicates that the authentication group's traps. Possible traps are: SNMP Authentication Fail: Enable/disable SNMP trap authentication failure trap.
Switch	Indicates the Switch group's traps. Possible traps are: STP: Enable/disable STP trap. RMON: Enable/disable RMON trap.

6.5.3 SNMP Community Configurations

This page allows you to configure SNMPv3 community table. The entry index key is **Community**.

SNMPv3 Community Configuration

Delete	Community	Source IP	Source Mask
<input type="checkbox"/>	public	0.0.0.0	0.0.0.0
<input type="checkbox"/>	private	0.0.0.0	0.0.0.0

Add New Entry
Save
Reset

Label	Description
Delete	Check to delete the entry. It will be deleted during the next save.
Community	Indicates the community access string to permit access to SNMPv3 agent. The allowed string length is 1 to 32, and only ASCII characters from 33 to 126 are allowed.
Source IP	Indicates the SNMP source address
Source Mask	Indicates the SNMP source address mask

6.5.4 SNMP User Configurations

This page allows you to configure SNMPv3 user table. The entry index keys are **Engine ID** and **User Name**.

SNMPv3 User Configuration							
Delete	Engine ID	User Name	Security Level	Authentication Protocol	Authentication Password	Privacy Protocol	Privacy Password
<input type="checkbox"/>	800007e5017f000001	default_user	NoAuth, NoPriv	None	None	None	None
<input type="button" value="Add New Entry"/> <input type="button" value="Save"/> <input type="button" value="Reset"/>							

Label	Description
Delete	Check to delete the entry. It will be deleted during the next save.
Engine ID	An octet string identifying the engine ID that this entry should belong to. The string must contain an even number between 10 and 64 hexadecimal digits, but all-zeros and all-'F's are not allowed. The SNMPv3 architecture uses User-based Security Model (USM) for message security and View-based Access Control Model (VACM) for access control. For the USM entry, the usmUserEngineID and usmUserName are the entry keys. In a simple agent, usmUserEngineID is always that agent's own snmpEngineID value. The value can also take the value of the snmpEngineID of a remote SNMP engine with which this user can communicate. In other words, if user engine ID is the same as system engine ID, then it is local user; otherwise it's remote user.
User Name	A string identifying the user name that this entry should belong to. The allowed string length is 1 to 32, and only ASCII characters from 33 to 126 are allowed.
Security Level	Indicates the security model that this entry should belong to.

	<p>Possible security models include:</p> <p>NoAuth, NoPriv: no authentication and none privacy</p> <p>Auth, NoPriv: Authentication and no privacy</p> <p>Auth, Priv: Authentication and privacy</p> <p>The value of security level cannot be modified if the entry already exists, which means the value must be set correctly at the time of entry creation.</p>
Authentication Protocol	<p>Indicates the authentication protocol that this entry should belong to. Possible authentication protocols include:</p> <p>None: no authentication protocol</p> <p>MD5: an optional flag to indicate that this user is using MD5 authentication protocol</p> <p>SHA: an optional flag to indicate that this user is using SHA authentication protocol</p> <p>The value of security level cannot be modified if the entry already exists, which means the value must be set correctly at the time of entry creation.</p>
Authentication Password	<p>A string identifying the authentication pass phrase. For MD5 authentication protocol, the allowed string length is 8 to 32. For SHA authentication protocol, the allowed string length is 8 to 40. Only ASCII characters from 33 to 126 are allowed.</p>
Privacy Protocol	<p>Indicates the privacy protocol that this entry should belong to. Possible privacy protocols include:</p> <p>None: no privacy protocol</p> <p>DES: an optional flag to indicate that this user is using DES authentication protocol</p>
Privacy Password	<p>A string identifying the privacy pass phrase. The allowed string length is 8 to 32, and only ASCII characters from 33 to 126 are allowed.</p>

6.5.5 SNMP Group Configurations

This page allows you to configure SNMPv3 group table. The entry index keys are **Security Model** and **Security Name**.

SNMPv3 Group Configuration

Delete	Security Model	Security Name	Group Name
<input type="checkbox"/>	v1	public	default_ro_group
<input type="checkbox"/>	v1	private	default_rw_group
<input type="checkbox"/>	v2c	public	default_ro_group
<input type="checkbox"/>	v2c	private	default_rw_group
<input type="checkbox"/>	usm	default_user	default_rw_group

Label	Description
Delete	Check to delete the entry. It will be deleted during the next save.
Security Model	Indicates the security model that this entry should belong to. Possible security models included: v1 : Reserved for SNMPv1. v2c : Reserved for SNMPv2c. usm : User-based Security Model (USM).
Security Name	A string identifying the security name that this entry should belong to. The allowed string length is 1 to 32, and only ASCII characters from 33 to 126 are allowed.
Group Name	A string identifying the group name that this entry should belong to. The allowed string length is 1 to 32, and only ASCII characters from 33 to 126 are allowed.

6.5.6 SNMP View Configurations

This page allows you to configure SNMPv3 view table. The entry index keys are **View Name** and **OID Subtree**.

SNMPv3 View Configuration

Delete	View Name	View Type	OID Subtree
<input type="checkbox"/>	default_view	included ▼	.1

Label	Description
Delete	Check to delete the entry. It will be deleted during the next save.

View Name	A string identifying the view name that this entry should belong to. The allowed string length is 1 to 32, and only ASCII characters from 33 to 126 are allowed.
View Type	Indicates the view type that this entry should belong to. Possible view types include: Included: an optional flag to indicate that this view subtree should be included. Excluded: An optional flag to indicate that this view subtree should be excluded. Generally, if an entry's view type is Excluded , it should exist another entry whose view type is Included , and its OID subtree oversteps the Excluded entry.
OID Subtree	The OID defining the root of the subtree to add to the named view. The allowed OID length is 1 to 128. The allowed string content is digital number or asterisk (*).

6.5.7 SNMP Access Configurations

This page allows you to configure SNMPv3 access table. The entry index keys are **Group Name**, **Security Model**, and **Security Level**.

SNMPv3 Access Configuration

Delete	Group Name	Security Model	Security Level	Read View Name	Write View Name
<input type="checkbox"/>	default_ro_group	any	NoAuth, NoPriv	default_view ▼	None ▼
<input type="checkbox"/>	default_rw_group	any	NoAuth, NoPriv	default_view ▼	default_view ▼

Label	Description
Delete	Check to delete the entry. It will be deleted during the next save.
Group Name	A string identifying the group name that this entry should belong to. The allowed string length is 1 to 32, and only ASCII characters from 33 to 126 are allowed.
Security Model	Indicates the security model that this entry should belong to. Possible security models include: any: Accepted any security model (v1 v2c usm). v1: Reserved for SNMPv1. v2c: Reserved for SNMPv2c. usm: User-based Security Model (USM).

Security Level	Indicates the security model that this entry should belong to. Possible security models include: NoAuth, NoPriv: no authentication and no privacy Auth, NoPriv: Authentication and no privacy Auth, Priv: Authentication and privacy
Read View Name	The name of the MIB view defining the MIB objects for which this request may request the current values. The allowed string length is 1 to 32, and only ASCII characters from 33 to 126 are allowed.
Write View Name	The name of the MIB view defining the MIB objects for which this request may potentially SET new values. The allowed string length is 1 to 32, and only ASCII characters from 33 to 126 are allowed.

6.5.8 RMON Statistics Configuration

RMON Statistics Configuration

Delete	ID	Data Source	
Delete	0	.1.3.6.1.2.1.2.2.1.1.	0

Add New Entry
Save
Reset

Label	Description
Delete	Check to delete the entry. It will be deleted during the next save.
ID	Indicates the index of the entry. The range is from 1 to 65535.
Data Source	Indicates the port ID which wants to be monitored. If in stacking switch, the value must add 1000000*(switch ID-1), for example, if the port is switch 3 port 5, the value is 2000005.

History Configuration

RMON History Configuration

Delete	ID	Data Source	Interval	Buckets	Buckets Granted
Delete	0	.1.3.6.1.2.1.2.2.1.1.	1800	50	

Add New Entry
Save
Reset

Label	Description
Delete	Check to delete the entry. It will be deleted during the next save.
ID	Indicates the index of the entry. The range is from 1 to 65535.
Data Source	Indicates the port ID which wants to be monitored. If in stacking switch, the value must add 1000000*(switch ID-1), for example, if the port is switch 3 port 5, the value is 2000005.
Interval	Indicates the interval in seconds for sampling the history statistics data. The range is from 1 to 3600, default value is 1800 seconds.
Buckets	Indicates the maximum data entries associated this History control entry stored in RMON. The range is from 1 to 3600, default value is 50.
Buckets Granted	The number of data shall be saved in the RMON.

Alarm Configuration

RMON Alarm Configuration

Delete	ID	Interval	Variable	Sample Type	Value	Startup Alarm	Rising Threshold	Rising Index	Falling Threshold	Falling Index
<input type="checkbox"/>	<input type="text"/>	<input type="text" value="30"/>	.1.3.6.1.2.1.2.2.1. 0,0	Delta ▾	<input type="text" value="0"/>	RisingOrFalling ▾	<input type="text" value="0"/>	<input type="text" value="0"/>	<input type="text" value="0"/>	<input type="text" value="0"/>
<input type="button" value="Add New Entry"/> <input type="button" value="Save"/> <input type="button" value="Reset"/>										

Label	Description
Delete	Check to delete the entry. It will be deleted during the next save.
ID	Indicates the index of the entry. The range is from 1 to 65535.
Interval	Indicates the interval in seconds for sampling and comparing the rising and falling threshold. The range is from 1 to 2 ³¹ -1.
Variable	<p>Indicates the particular variable to be sampled, the possible variables are:</p> <p>InOctets: The total number of octets received on the interface, including framing characters.</p> <p>InUcastPkts: The number of uni-cast packets delivered to a higher-layer protocol.</p> <p>InNUcastPkts: The number of broad-cast and multi-cast packets delivered to a higher-layer protocol.</p> <p>InDiscards: The number of inbound packets that are discarded even the packets are normal.</p> <p>InErrors: The number of inbound packets that contained errors preventing them from being deliverable to a higher-layer protocol.</p> <p>InUnknownProtos: the number of the inbound packets that were</p>

	<p>discarded because of the unknown or un-support protocol.</p> <p>OutOctets: The number of octets transmitted out of the interface , including framing characters.</p> <p>OutUcastPkts: The number of uni-cast packets that request to transmit.</p> <p>OutNUcastPkts: The number of broad-cast and multi-cast packets that request to transmit.</p> <p>OutDiscards: The number of outbound packets that are discarded even the packets are normal.</p> <p>OutErrors: The number of outbound packets that could not be transmitted because of errors.</p> <p>OutQLen: The length of the output packet queue (in packets).</p>
Sample Type	<p>The method of sampling the selected variable and calculating the value to be compared against the thresholds, possible sample types are:</p> <p>Absolute: Get the sample directly.</p> <p>Delta: Calculate the difference between samples (default).</p>
Value	The value of the statistic during the last sampling period.
Startup Alarm	<p>The method of sampling the selected variable and calculating the value to be compared against the thresholds, possible sample types are:</p> <p>Rising Trigger alarm when the first value is larger than the rising threshold.</p> <p>Falling Trigger alarm when the first value is less than the falling threshold.</p> <p>RisingOrFalling Trigger alarm when the first value is larger than the rising threshold or less than the falling threshold (default).</p>
Rising Threshold	Rising threshold value (-2147483648-2147483647).
Rising Index	Rising event index (1-65535).
Falling Threshold	Falling threshold value (-2147483648-2147483647)
Falling Index	Falling event index (1-65535).

Event Configuration

RMON Alarm Configuration

Delete	ID	Interval	Variable	Sample Type	Value	Startup Alarm	Rising Threshold	Rising Index	Falling Threshold	Falling Index
Delete		30	.1.3.6.1.2.1.2.2.1.0.0	Delta	0	RisingOrFalling	0	0	0	0

Add New Entry Save Reset

Label	Description
Delete	Check to delete the entry. It will be deleted during the next save.
ID	Indicates the index of the entry. The range is from 1 to 65535.
Desc	Indicates this event, the string length is from 0 to 127, default is a null string.
Type	Indicates the notification of the event, the possible types are: none : No SNMP log is created, no SNMP trap is sent. log : Create SNMP log entry when the event is triggered. snmptrap : Send SNMP trap when the event is triggered. logandtrap : Create SNMP log entry and sent SNMP trap when the event is triggered.
Community	Specify the community when trap is sent, the string length is from 0 to 127, default is "public".
Event Last Time	Indicates the value of sysUpTime at the time this event entry last generated an event.

Statistics Stauts

RMON Statistics Status Overview																		
Auto-refresh <input type="checkbox"/> Refresh << >>																		
Start from Control Index 0 with 20 entries per page.																		
ID	Data Source (ifIndex)	Drop	Octets	Pkts	Broad-cast	Multi-cast	CRC Errors	Under-size	Over-size	Frag.	Jabb.	Coll.	64 Bytes	65 ~ 127	128 ~ 255	256 ~ 511	512 ~ 1023	1024 ~ 1588
No more entries																		

Label	Description
ID	Indicates the index of Statistics entry.
Data Source	The port ID which wants to be monitored.
Octets	The total number of events in which packets were dropped by the probe due to lack of resources.
Pkts	The total number of packets (including bad packets, broadcast packets, and multicast packets) received.
Broad-Cast	The total number of good packets received that were directed to the broadcast address.
Muulti-Cast	The total number of good packets received that were directed to a multicast address.
CRC Errors	The total number of packets received that had a length (excluding framing bits, but including FCS octets) of between 64 and 1518

	octets, inclusive, but had either a bad Frame Check Sequence (FCS) with an integral number of octets (FCS Error) or a bad FCS with a non-integral number of octets (Alignment Error).
Under-size	The total number of packets received that were less than 64 octets.
Over-size	The total number of packets received that were longer than 1518 octets.
Frag	The number of frames which size is less than 64 octets received with invalid CRC.
Jabb	The number of frames which size is larger than 64 octets received with invalid CRC.
Coll.	The best estimate of the total number of collisions on this Ethernet segment.
64	The total number of packets (including bad packets) received that were 64 octets in length.
65~127	The total number of packets (including bad packets) received that are between 65 to 127 octets in length.
128~255	The total number of packets (including bad packets) received that are between 128 to 255 octets in length.
256~511	The total number of packets (including bad packets) received that are between 256 to 511 octets in length.
512~1023	The total number of packets (including bad packets) received that are between 512 to 1023 octets in length.
1024~1588	The total number of packets (including bad packets) received that were between 1024 to 1588 octets in length.

History Status

RMON History Overview

Auto-refresh Refresh | << >>

Start from Control Index 0 and Sample Index 0 with 20 entries per page.

History Index	Sample Index	Sample Start	Drop	Octets	Pkts	Broad-cast	Multi-cast	CRC Errors	Under-size	Over-size	Frag.	Jabb.	Coll.	Utilization
No more entries														

Label	Description
History Index	Indicates the index of History control entry.
Sample Index	Indicates the index of the data entry associated with the control entry.
Sample Start	The value of sysUpTime at the start of the interval over which this sample was measured.

Drop	The total number of events in which packets were dropped by the probe due to lack of resources.
Octets	The total number of octets of data (including those in bad packets) received on the network.
Pkts	The total number of packets (including bad packets, broadcast packets, and multicast packets) received.
Broadcast	The total number of good packets received that were directed to the broadcast address.
Multicast	The total number of good packets received that were directed to a multicast address.
CRC Error	The total number of packets received that had a length (excluding framing bits, but including FCS octets) of between 64 and 1518 octets, inclusive, but had either a bad Frame Check Sequence (FCS) with an integral number of octets (FCS Error) or a bad FCS with a non-integral number of octets (Alignment Error).
Undersize	The total number of packets received that were less than 64 octets.
Oversize	The total number of packets received that were longer than 1518 octets.
Frag.	The number of frames which size is less than 64 octets received with invalid CRC.
Jabb.	The total number of packets received that were longer than 1518 octets.
Coll.	The best estimate of the total number of collisions on this Ethernet segment.
Utilization	The best estimate of the mean physical layer network utilization on this interface during this sampling interval, in hundredths of a percent.

Alarm Status

RMON Alarm Overview

Auto-refresh Refresh |<< >>

Start from Control Index with entries per page.

ID	Interval	Variable	Sample Type	Value	Startup Alarm	Rising Threshold	Rising Index	Falling Threshold	Falling Index
No more entries									

Label	Description
ID	Indicates the index of Alarm control entry.
Interval	Indicates the interval in seconds for sampling and comparing the rising and falling threshold.
Variable	Indicates the particular variable to be sampled
Sample Type	The method of sampling the selected variable and calculating the value to be compared against the thresholds.
Value	The value of the statistic during the last sampling period.
Startup Alarm	The alarm that may be sent when this entry is first set to valid.
Rising Threshold	Rising threshold value.
Rising Index	Rising threshold value.
Filing Threshold	Falling threshold value.
Falling Index	Falling event index.

Event Status

RMON Event Overview

Auto-refresh Refresh |<< >>

Start from Control Index 0 and Sample Index 0 with 20 entries per page.

Event Index	LogIndex	LogTime	LogDescription
No more entries			

Label	Description
Event Index	Indicates the index of the event entry.
Log Index	Indicates the index of the log entry.
Log Time	Indicates Event log time
LogDescripti	Indicates the Event description.

6.6 Traffic Prioritization

6.6.1 Storm Control

There is a unicast storm rate control, multicast storm rate control, and a broadcast storm rate control. These only affect flooded frames, i.e. frames with a (VLAN ID, DMAC) pair not present on the MAC Address table.

The rate is 2^n , where n is equal to or less than 15, or "No Limit". The unit of the rate can be either pps (packets per second) or kpps (kilopackets per second). The configuration indicates the permitted packet rate for unicast, multicast, or broadcast traffic across the switch.

Note: frames sent to the CPU of the switch are always limited to approximately 4 kpps. For example, broadcasts in the management VLAN are limited to this rate. The management VLAN is configured on the IP setup page.

Frame Type	Status	Rate (pps)
Unicast	<input type="checkbox"/>	1K
Multicast	<input type="checkbox"/>	1K
Broadcast	<input type="checkbox"/>	1K

Save Reset

Label	Description
Frame Type	The settings in a particular row apply to the frame type listed here: unicast , multicast , or broadcast .
Status	Enable or disable the storm control status for the given frame type.
Rate	The rate unit is packet per second (pps), configure the rate as 1K, 2K, 4K, 8K, 16K, 32K, 64K, 128K, 256K, 512K, or 1024K. The 1 kpps is actually 1002.1 pps.

6.6.2 Port Classification

QoS is an acronym for Quality of Service. It is a method to achieve efficient bandwidth utilization between individual applications or protocols.

QoS Ingress Port Classification

Port	QoS class	DP level	PCP	DEI	Tag Class.	DSCP Based
*	<> ▾	<> ▾	<> ▾	<> ▾		<input type="checkbox"/>
1	0 ▾	0 ▾	0 ▾	0 ▾	Disabled	<input type="checkbox"/>
2	0 ▾	0 ▾	0 ▾	0 ▾	Disabled	<input type="checkbox"/>
3	0 ▾	0 ▾	0 ▾	0 ▾	Disabled	<input type="checkbox"/>
4	0 ▾	0 ▾	0 ▾	0 ▾	Disabled	<input type="checkbox"/>
5	0 ▾	0 ▾	0 ▾	0 ▾	Disabled	<input type="checkbox"/>
6	0 ▾	0 ▾	0 ▾	0 ▾	Disabled	<input type="checkbox"/>
7	0 ▾	0 ▾	0 ▾	0 ▾	Disabled	<input type="checkbox"/>

Label	Description
Port	The port number for which the configuration below applies
QoS Class	<p>Controls the default QoS class</p> <p>All frames are classified to a QoS class. There is a one to one mapping between QoS class, queue, and priority. A QoS class of 0 (zero) has the lowest priority.</p> <p>If the port is VLAN aware and the frame is tagged, then the frame is classified to a QoS class that is based on the PCP value in the tag as shown below. Otherwise the frame is classified to the default QoS class.</p> <p>PCP value: 0 1 2 3 4 5 6 7</p> <p>QoS class: 1 0 2 3 4 5 6 7</p> <p>If the port is VLAN aware, the frame is tagged, and Tag Class is enabled, then the frame is classified to a QoS class that is mapped from the PCP and DEI value in the tag. Otherwise the frame is classified to the default QoS class.</p> <p>The classified QoS class can be overruled by a QCL entry.</p> <p>Note: if the default QoS class has been dynamically changed, then the actual default QoS class is shown in parentheses after the configured default QoS class.</p>
DP level	<p>Controls the default Drop Precedence Level</p> <p>All frames are classified to a DP level.</p> <p>If the port is VLAN aware and the frame is tagged, then the frame is classified to a DP level that is equal to the DEI value in the tag. Otherwise the frame is classified to the default DP level.</p> <p>If the port is VLAN aware, the frame is tagged, and Tag Class is</p>

	<p>enabled, then the frame is classified to a DP level that is mapped from the PCP and DEI value in the tag. Otherwise the frame is classified to the default DP level.</p> <p>The classified DP level can be overruled by a QCL entry.</p>
PCP	<p>Controls the default PCP value</p> <p>All frames are classified to a PCP value.</p> <p>If the port is VLAN aware and the frame is tagged, then the frame is classified to the PCP value in the tag. Otherwise the frame is classified to the default PCP value.</p>
DEI	<p>Controls the default DEI value</p> <p>All frames are classified to a DEI value.</p> <p>If the port is VLAN aware and the frame is tagged, then the frame is classified to the DEI value in the tag. Otherwise the frame is classified to the default DEI value.</p>
Tag Class	<p>Shows the classification mode for tagged frames on this port</p> <p>Disabled: Use default QoS class and DP level for tagged frames</p> <p>Enabled: Use mapped versions of PCP and DEI for tagged frames</p> <p>Click on the mode to configure the mode and/or mapping</p> <p>Note: this setting has no effect if the port is VLAN unaware.</p> <p>Tagged frames received on VLAN-unaware ports are always classified to the default QoS class and DP level.</p>
DSCP Based	Click to enable DSCP Based QoS Ingress Port Classification

6.6.3 Port Tag Remaking

This page provides an overview of QoS Egress Port Tag Remarking for all switch ports.

QoS Egress Port Tag Remarking

Port	Mode
1	Classified
2	Classified
3	Classified
4	Classified
5	Classified
6	Classified
7	Classified

Label	Description
Port	The switch port number to which the following settings will be

	applied. Click on the port number to configure tag remarking
Mode	Shows the tag remarking mode for this port Classified: use classified PCP/DEI values Default: use default PCP/DEI values Mapped: use mapped versions of QoS class and DP level

6.6.4 Port DSCP

This page allows you to configure basic QoS Port DSCP settings for all switch ports.

QoS Port DSCP Configuration			
Port	Ingress		Egress
	Translate	Classify	Rewrite
*	<input type="checkbox"/>	<>	<>
1	<input type="checkbox"/>	Disable	Disable
2	<input type="checkbox"/>	Disable	Disable
3	<input type="checkbox"/>	Disable	Disable
4	<input type="checkbox"/>	Disable	Disable
5	<input type="checkbox"/>	Disable	Disable
6	<input type="checkbox"/>	Disable	Disable

Label	Description
Port	Shows the list of ports for which you can configure DSCP Ingress and Egress settings.
Ingress	In Ingress settings you can change ingress translation and classification settings for individual ports. There are two configuration parameters available in Ingress: 1. Translate 2. Classify
1. Translate	Check to enable ingress translation
2. Classify	Classification has 4 different values. Disable: no Ingress DSCP classification DSCP=0: classify if incoming (or translated if enabled) DSCP is 0. Selected: classify only selected DSCP whose classification is enabled as specified in DSCP Translation window for the specific DSCP. All: classify all DSCP
Egress	Port egress rewriting can be one of the following options:

	<p>Disable: no Egress rewrite</p> <p>Enable: rewrite enabled without remapping</p> <p>Remap DP Unaware: DSCP from the analyzer is remapped and the frame is remarked with a remapped DSCP value. The remapped DSCP value is always taken from the 'DSCP Translation->Egress Remap DP0' table.</p> <p>Remap DP Aware: DSCP from the analyzer is remapped and the frame is remarked with a remapped DSCP value. Depending on the DP level of the frame, the remapped DSCP value is either taken from the 'DSCP Translation->Egress Remap DP0' table or from the 'DSCP Translation->Egress Remap DP1' table.</p>
--	---

6.6.5 Port Policing

This page allows you to configure Policer settings for all switch ports.

QoS Ingress Port Policers				
Port	Enabled	Rate	Unit	Flow Control
*	<input type="checkbox"/>	500	<>	<input type="checkbox"/>
1	<input type="checkbox"/>	500	kbps	<input type="checkbox"/>
2	<input type="checkbox"/>	500	kbps	<input type="checkbox"/>
3	<input type="checkbox"/>	500	kbps	<input type="checkbox"/>
4	<input type="checkbox"/>	500	kbps	<input type="checkbox"/>
5	<input type="checkbox"/>	500	kbps	<input type="checkbox"/>
6	<input type="checkbox"/>	500	kbps	<input type="checkbox"/>

Label	Description
Port	The port number for which the configuration below applies
Enable	Check to enable the policer for individual switch ports
Rate	Configures the rate of each policer. The default value is 500 . This value is restricted to 100 to 1000000 when the Unit is kbps or fps , and is restricted to 1 to 3300 when the Unit is Mbps or kfps .
Unit	Configures the unit of measurement for each policer rate as kbps , Mbps , fps , or kfps . The default value is kbps .
Flow Control	If Flow Control is enabled and the port is in Flow Control mode, then pause frames are sent instead of being

	discarded.
--	------------

6.6.6 Queue Policing

This page allows you to configure Queue Policer settings for all switch ports.

QoS Ingress Queue Policers

Port	Queue 0			Queue 1	Queue 2	Queue 3	Queue 4	Queue 5	Queue 6	Queue 7
	E	Rate	Unit	Enable	Enable	Enable	Enable	Enable	Enable	Enable
*	<input checked="" type="checkbox"/>	500	<>	<input type="checkbox"/>	<input type="checkbox"/>	<input type="checkbox"/>	<input type="checkbox"/>	<input type="checkbox"/>	<input type="checkbox"/>	<input type="checkbox"/>
1	<input checked="" type="checkbox"/>	500	kbps	<input type="checkbox"/>	<input type="checkbox"/>	<input type="checkbox"/>	<input type="checkbox"/>	<input type="checkbox"/>	<input type="checkbox"/>	<input type="checkbox"/>
2	<input checked="" type="checkbox"/>	500	kbps	<input type="checkbox"/>	<input type="checkbox"/>	<input type="checkbox"/>	<input type="checkbox"/>	<input type="checkbox"/>	<input type="checkbox"/>	<input type="checkbox"/>
3	<input checked="" type="checkbox"/>	500	kbps	<input type="checkbox"/>	<input type="checkbox"/>	<input type="checkbox"/>	<input type="checkbox"/>	<input type="checkbox"/>	<input type="checkbox"/>	<input type="checkbox"/>
4	<input checked="" type="checkbox"/>	500	kbps	<input type="checkbox"/>	<input type="checkbox"/>	<input type="checkbox"/>	<input type="checkbox"/>	<input type="checkbox"/>	<input type="checkbox"/>	<input type="checkbox"/>
5	<input checked="" type="checkbox"/>	500	kbps	<input type="checkbox"/>	<input type="checkbox"/>	<input type="checkbox"/>	<input type="checkbox"/>	<input type="checkbox"/>	<input type="checkbox"/>	<input type="checkbox"/>

Label	Description
Port	The port number for which the configuration below applies.
Enable(E)	Check to enable queue policer for individual switch ports
Rate	Configures the rate of each queue policer. The default value is 500 . This value is restricted to 100 to 1000000 when the Unit is kbps , and is restricted to 1 to 3300 when the Unit is Mbps . This field is only shown if at least one of the queue policers is enabled.
Unit	Configures the unit of measurement for each queue policer rate as kbps or Mbps. The default value is kbps . This field is only shown if at least one of the queue policers is enabled.

5.6.7 QoS Egress Port Scheduler and Shapers

This page allows you to configure Scheduler and Shapers for a specific port.

Strict Priority

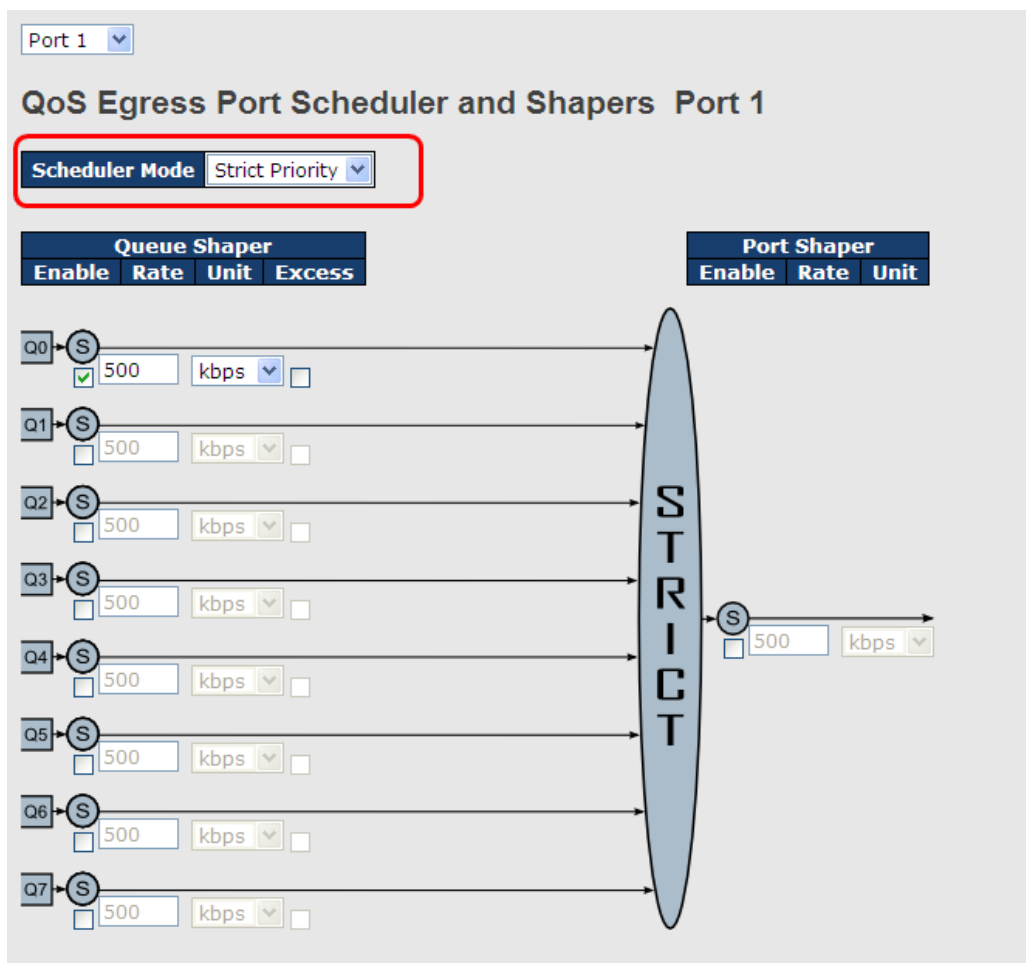

Label	Description
Scheduler Mode	Controls whether the scheduler mode is Strict Priority or Weighted on this switch port
Queue Shaper Enable	Check to enable queue shaper for individual switch ports
Queue Shaper Rate	Configures the rate of each queue shaper. The default value is 500 . This value is restricted to 100 to 1000000 when the Unit is kbps ", and it is restricted to 1 to 3300 when the Unit is Mbps .
Queues Shaper Unit	Configures the rate for each queue shaper. The default value is 500 . This value is restricted to 100 to 1000000 when the Unit is kbps , and it is restricted to 1 to 3300 when the Unit is Mbps .
Queue Shaper Excess	Allows the queue to use excess bandwidth
Port Shaper Enable	Check to enable port shaper for individual switch ports
Port Shaper Rate	Configures the rate of each port shaper. The default value is 500 This value is restricted to 100 to 1000000 when the Unit is kbps ,

	and it is restricted to 1 to 3300 when the Unit is Mbps .
Port Shaper Unit	Configures the unit of measurement for each port shaper rate as kbps or Mbps . The default value is kbps .

Weighted

Port 1

QoS Egress Port Scheduler and Shapers Port 1

Scheduler Mode: Weighted

Queue Shaper				Queue Scheduler		Port Shaper		
Enable	Rate	Unit	Excess	Weight	Percent	Enable	Rate	Unit
<input type="checkbox"/>	500	kbps	<input type="checkbox"/>	17	17%	<input type="checkbox"/>	500	kbps
<input type="checkbox"/>	500	kbps	<input type="checkbox"/>	17	17%	<input type="checkbox"/>	500	kbps
<input type="checkbox"/>	500	kbps	<input type="checkbox"/>	17	17%	<input type="checkbox"/>	500	kbps
<input type="checkbox"/>	500	kbps	<input type="checkbox"/>	17	17%	<input type="checkbox"/>	500	kbps
<input type="checkbox"/>	500	kbps	<input type="checkbox"/>	17	17%	<input type="checkbox"/>	500	kbps
<input type="checkbox"/>	500	kbps	<input type="checkbox"/>	17	17%	<input type="checkbox"/>	500	kbps
<input type="checkbox"/>	500	kbps	<input type="checkbox"/>	17	17%	<input type="checkbox"/>	500	kbps
<input type="checkbox"/>	500	kbps	<input type="checkbox"/>	17	17%	<input type="checkbox"/>	500	kbps

Label	Description
Scheduler Mode	Controls whether the scheduler mode is Strict Priority or Weighted on this switch port
Queue Shaper Enable	Check to enable queue shaper for individual switch ports
Queue Shaper Rate	Configures the rate of each queue shaper. The default value is 500 . This value is restricted to 100 to 1000000 when the Unit is kbps , and it is restricted to 1 to 3300 when the Unit is Mbps .
Queues Shaper Unit	Configures the rate of each queue shaper. The default value is 500 . This value is restricted to 100 to 1000000 when the Unit is kbps , and it is restricted to 1 to 3300 when the Unit is Mbps .

	kbps , and it is restricted to 1 to 3300 when the Unit is Mbps .
Queue Shaper Excess	Allows the queue to use excess bandwidth
Queue Scheduler Weight	Configures the weight of each queue. The default value is 17 . This value is restricted to 1 to 100. This parameter is only shown if Scheduler Mode is set to Weighted .
Queue Scheduler Percent	Shows the weight of the queue in percentage. This parameter is only shown if Scheduler Mode is set to Weighted .
Port Shaper Enable	Check to enable port shaper for individual switch ports
Port Shaper Rate	Configures the rate of each port shaper. The default value is 500 . This value is restricted to 100 to 1000000 when the Unit is kbps , and it is restricted to 1 to 3300 when the Unit is Mbps .
Port Shaper Unit	Configures the unit of measurement for each port shaper rate as kbps or Mbps . The default value is kbps .

5.6.8 Port Scheduler

This page provides an overview of QoS Egress Port Schedulers for all switch ports.

QoS Egress Port Schedulers							
Port	Mode	Weight					
		Q0	Q1	Q2	Q3	Q4	Q5
1	Strict Priority	-	-	-	-	-	-
2	Strict Priority	-	-	-	-	-	-
3	Strict Priority	-	-	-	-	-	-
4	Strict Priority	-	-	-	-	-	-
5	Strict Priority	-	-	-	-	-	-
6	Strict Priority	-	-	-	-	-	-

Label	Description
Port	The switch port number to which the following settings will be applied. Click on the port number to configure the schedulers
Mode	Shows the scheduling mode for this port
Qn	Shows the weight for this queue and port

5.6.9 Port Shaping

This page provides an overview of QoS Egress Port Shapers for all switch ports.

QoS Egress Port Shapers

Port	Shapers								Port	
	Q0	Q1	Q2	Q3	Q4	Q5	Q6	Q7		
1	disabled	disabled	disabled	disabled	disabled	disabled	disabled	disabled	disabled	disabled
2	disabled	disabled	disabled	disabled	disabled	disabled	disabled	disabled	disabled	disabled
3	disabled	disabled	disabled	disabled	disabled	disabled	disabled	disabled	disabled	disabled
4	disabled	disabled	disabled	disabled	disabled	disabled	disabled	disabled	disabled	disabled
5	disabled	disabled	disabled	disabled	disabled	disabled	disabled	disabled	disabled	disabled
6	disabled	disabled	disabled	disabled	disabled	disabled	disabled	disabled	disabled	disabled

Label	Description
Port	The switch port number to which the following settings will be applied. Click on the port number to configure the shapers
Mode	Shows disabled or actual queue shaper rate - e.g. "800 Mbps"
Qn	Shows disabled or actual port shaper rate - e.g. "800 Mbps"

5.6.10 DSCP-Based QoS

This page allows you to configure basic QoS DSCP-based QoS Ingress Classification settings for all switches.

DSCP-Based QoS Ingress Classification

DSCP	Trust	QoS Class	DPL
*	<input type="checkbox"/>	<> ▾	<> ▾
0 (BE)	<input type="checkbox"/>	0 ▾	0 ▾
1	<input type="checkbox"/>	0 ▾	0 ▾
2	<input type="checkbox"/>	0 ▾	0 ▾
3	<input type="checkbox"/>	0 ▾	0 ▾
4	<input type="checkbox"/>	0 ▾	0 ▾
5	<input type="checkbox"/>	0 ▾	0 ▾

Label	Description
DSCP	Maximum number of supported DSCP values is 64
Trust	Check to trust a specific DSCP value. Only frames with trusted DSCP values are mapped to a specific QoS class and drop precedence level. Frames with untrusted DSCP values are treated as a non-IP frame.
QoS Class	QoS class value can be any number from 0-7.
DPL	Drop Precedence Level (0-1)

5.6.11 DSCP Translation

This page allows you to configure basic QoS DSCP translation settings for all switches. DSCP translation can be done in **Ingress** or **Egress**.

DSCP	Ingress		Egress	
	Translate	Classify	Remap DP0	Remap DP1
*	<>	<input type="checkbox"/>	<>	<>
0 (BE)	0 (BE)	<input type="checkbox"/>	0 (BE)	0 (BE)
1	1	<input type="checkbox"/>	1	1
2	2	<input type="checkbox"/>	2	2
3	3	<input type="checkbox"/>	3	3
4	4	<input type="checkbox"/>	4	4
5	5	<input type="checkbox"/>	5	5
6	6	<input type="checkbox"/>	6	6
7	7	<input type="checkbox"/>	7	7
8 (CS1)	8 (CS1)	<input type="checkbox"/>	8 (CS1)	8 (CS1)
9	9	<input type="checkbox"/>	9	9

Label	Description
DSCP	Maximum number of supported DSCP values is 64 and valid DSCP value ranges from 0 to 63.
Ingress	Ingress DSCP can be first translated to new DSCP before using the DSCP for QoS class and DPL map. There are two configuration parameters for DSCP Translation - 1. Translate: DSCP can be translated to any of (0-63) DSCP values. 2. Classify: check to enable ingress classification
Egress	Configurable egress parameters include; Remap DP0: controls the remapping for frames with DP level 0. You can select the DSCP value from a selected menu to which you want to remap. DSCP value ranges from 0 to 63. Remap DP1: controls the remapping for frames with DP level 1. You can select the DSCP value from a selected menu to which you want to remap. DSCP value ranges from 0 to 63.

5.6.12 DSCP Classification

This page allows you to configure the mapping of QoS class and Drop Precedence Level to DSCP value.

DSCP Classification		
QoS Class	DPL	DSCP
*	*	<>
0	0	0 (BE)
0	1	8 (CS1)
1	0	14 (AF13)
1	1	0 (BE)
2	0	0 (BE)

Label	Description
QoS Class	Actual QoS class
DPL	Actual Drop Precedence Level
DSCP	Select the classified DSCP value (0-63)

5.6.13 QoS Control List

This page allows you to edit or insert a single QoS control entry at a time. A QCE consists of several parameters. These parameters vary with the frame type you select.

QCE Configuration

Port Members																			
1	2	3	4	5	6	7	8	9	10	11	12	13	14	15	16	17	18	19	20
✓	✓	✓	✓	✓	✓	✓	✓	✓	✓	✓	✓	✓	✓	✓	✓	✓	✓	✓	✓

Key Parameters

Tag	Tag	Value:	
VID	Specific	Value:	
PCP	2		
DEI	0		
SMAC	Specific	0x	00-00-00
DMAC Type	UC		
Frame Type	Ethernet		

Action Parameters

Class	3
DPL	1
DSCP	28 (AF32)

MAC Parameters

Ether Type	Specific	Value:	0xFFFF
-------------------	----------	--------	--------

Label	Description
Port Members	Check to include the port in the QCL entry. By default, all ports are included.
Key Parameters	<p>Key configurations include:</p> <p>Tag: value of tag, can be Any, Untag or Tag.</p> <p>VID: valid value of VLAN ID, can be any value from 1 to 4095</p> <p>Any: user can enter either a specific value or a range of VIDs.</p> <p>PCP: Priority Code Point, can be specific numbers (0, 1, 2, 3, 4, 5, 6, 7), a range (0-1, 2-3, 4-5, 6-7, 0-3, 4-7) or Any</p> <p>DEI: Drop Eligible Indicator, can be any of values between 0 and 1 or Any</p> <p>SMAC: Source MAC Address, can be 24 MS bits (OUI) or Any</p> <p>DMAC Type: Destination MAC type, can be unicast (UC), multicast (MC), broadcast (BC) or Any</p> <p>Frame Type can be the following values:</p> <p>Any</p> <p>Ethernet</p> <p>LLC</p> <p>SNAP</p> <p>IPv4</p> <p>IPv6</p> <p>Note: all frame types are explained below.</p>
Any	Allow all types of frames
Ethernet	Valid Ethernet values can range from 0x600 to 0xFFFF or 'Any' but excluding 0x800(IPv4) and 0x86DD(IPv6). The default value is Any .
LLC	<p>SSAP Address: valid SSAP (Source Service Access Point) values can range from 0x00 to 0xFF or Any. The default value is Any.</p> <p>DSAP Address: valid DSAP (Destination Service Access Point) values can range from 0x00 to 0xFF or Any. The default value is Any.</p> <p>Control Valid Control: valid values can range from 0x00 to 0xFF or Any. The default value is Any.</p>
SNAP	PID: valid PID (a.k.a ethernet type) values can range from

	0x00 to 0xFFFF or Any. The default value is Any.
IPv4	<p>Protocol IP Protocol Number: (0-255, TCP or UDP) or Any</p> <p>Source IP: specific Source IP address in value/mask format or Any. IP and mask are in the format of x.y.z.w where x, y, z, and w are decimal numbers between 0 and 255. When the mask is converted to a 32-bit binary string and read from left to right, all bits following the first zero must also be zero.</p> <p>DSCP (Differentiated Code Point): can be a specific value, a range, or Any. DSCP values are in the range 0-63 including BE, CS1-CS7, EF or AF11-AF43.</p> <p>IP Fragment: Ipv4 frame fragmented options include 'yes', 'no', and 'any'.</p> <p>Sport Source TCP/UDP Port: (0-65535) or Any, specific value or port range applicable for IP protocol UDP/TCP</p> <p>Dport Destination TCP/UDP Port: (0-65535) or Any, specific value or port range applicable for IP protocol UDP/TCP</p>
IPv6	<p>Protocol IP protocol number: (0-255, TCP or UDP) or Any</p> <p>Source IP IPv6 source address: (a.b.c.d) or Any, 32 LS bits</p> <p>DSCP (Differentiated Code Point): can be a specific value, a range, or Any. DSCP values are in the range 0-63 including BE, CS1-CS7, EF or AF11-AF43.</p> <p>Sport Source TCP/UDP port: (0-65535) or Any, specific value or port range applicable for IP protocol UDP/TCP</p> <p>Dport Destination TCP/UDP port: (0-65535) or Any, specific value or port range applicable for IP protocol UDP/TCP</p>
Action Parameters	<p>Class QoS class: (0-7) or Default</p> <p>Valid Drop Precedence Level value can be (0-1) or Default.</p> <p>Valid DSCP value can be (0-63, BE, CS1-CS7, EF or AF11-AF43) or Default.</p> <p>Default means that the default classified value is not modified by this QCE.</p>

5.6.14 QoS Counters

This page provides the statistics of individual queues for all switch ports.

Queuing Counters

Auto-refresh

Port	Q0		Q1		Q2		Q3		Q4		Q5		Q6		Q7	
	Rx	Tx	Rx	Tx	Rx	Tx	Rx	Tx	Rx	Tx	Rx	Tx	Rx	Tx	Rx	Tx
1	0	0	0	0	0	0	0	0	0	0	0	0	0	0	0	0
2	0	0	0	0	0	0	0	0	0	0	0	0	0	0	0	0
3	0	0	0	0	0	0	0	0	0	0	0	0	0	0	0	0
4	0	0	0	0	0	0	0	0	0	0	0	0	0	0	0	0
5	0	0	0	0	0	0	0	0	0	0	0	0	0	0	0	0
6	0	0	0	0	0	0	0	0	0	0	0	0	0	0	0	0
7	586	0	0	0	0	0	0	0	0	0	0	0	0	0	0	493
8	1307	0	0	0	0	0	0	0	0	0	0	0	0	0	0	2326
9	0	0	0	0	0	0	0	0	0	0	0	0	0	0	0	0

Label	Description
Port	The switch port number to which the following settings will be applied.
Qn	There are 8 QoS queues per port. Q0 is the lowest priority
Rx / Tx	The number of received and transmitted packets per queue

5.6.15 QCL Status

This page shows the QCL status by different QCL users. Each row describes the QCE that is defined. It is a conflict if a specific QCE is not applied to the hardware due to hardware limitations. The maximum number of QCEs is 256 on each switch.

Combined

QoS Control List Status

User	QCE#	Frame Type	Port	Action			Conflict
				Class	DPL	DSCP	
No entries							

Label	Description
User	Indicates the QCL user
QCE#	Indicates the index of QCE
Frame Type	Indicates the type of frame to look for incoming frames. Possible frame types are: Any: the QCE will match all frame type. Ethernet: Only Ethernet frames (with Ether Type 0x600-0xFFFF) are allowed. LLC: Only (LLC) frames are allowed.

	<p>SNAP: Only (SNAP) frames are allowed.</p> <p>IPv4: the QCE will match only IPV4 frames.</p> <p>IPv6: the QCE will match only IPV6 frames.</p>
Port	Indicates the list of ports configured with the QCE.
Action	<p>Indicates the classification action taken on ingress frame if parameters configured are matched with the frame's content.</p> <p>There are three action fields: Class, DPL, and DSCP.</p> <p>Class: Classified QoS; if a frame matches the QCE, it will be put in the queue.</p> <p>DPL: Drop Precedence Level; if a frame matches the QCE, then DP level will set to a value displayed under DPL column.</p> <p>DSCP: if a frame matches the QCE, then DSCP will be classified with the value displayed under DSCP column.</p>
Conflict	<p>Displays the conflict status of QCL entries. As hardware resources are shared by multiple applications, resources required to add a QCE may not be available. In that case, it shows conflict status as Yes, otherwise it is always No. Please note that conflict can be resolved by releasing the hardware resources required to add the QCL entry by pressing Resolve Conflict button.</p>

5.6.16 WRED

This page allows you to configure the Random Early Detection (RED) settings.

Through different RED configuration for the queues (QoS classes) it is possible to obtain Weighted Random Early Detection (WRED) operation between queues.

The settings are global for all ports in the switch.

Weighted Random Early Detection Configuration

Group	Queue	DPL	Enable	Min	Max	Max Unit
1	0	1	<input type="checkbox"/>	0	50	Drop Probability ▼
1	0	2	<input type="checkbox"/>	0	50	Drop Probability ▼
1	0	3	<input type="checkbox"/>	0	50	Drop Probability ▼
1	1	1	<input type="checkbox"/>	0	50	Drop Probability ▼
1	1	2	<input type="checkbox"/>	0	50	Drop Probability ▼
1	1	3	<input type="checkbox"/>	0	50	Drop Probability ▼
1	2	1	<input type="checkbox"/>	0	50	Drop Probability ▼
1	2	2	<input type="checkbox"/>	0	50	Drop Probability ▼
1	2	3	<input type="checkbox"/>	0	50	Drop Probability ▼
1	3	1	<input type="checkbox"/>	0	50	Drop Probability ▼

Label	Description
Group	The WRED group number for which the configuration below applies.
Queue	The queue number (QoS class) for which the configuration below applies.
DPL	The Drop Precedence Level for which the configuration below applies.
Enable	Controls whether RED is enabled for this entry.
Min	Controls the lower RED fill level threshold. If the queue filling level is below this threshold, the drop probability is zero. This value is restricted to 0-100%.
Max	Controls the upper RED drop probability or fill level threshold for frames marked with Drop Precedence Level > 0 (yellow frames). This value is restricted to 1-100%.
Max Unit	Selects the unit for Max. Possible values are: Drop Probability: Max controls the drop probability just below 100% fill level. Fill Level: Max controls the fill level where drop probability reaches 100%.

RED Drop Probability Function

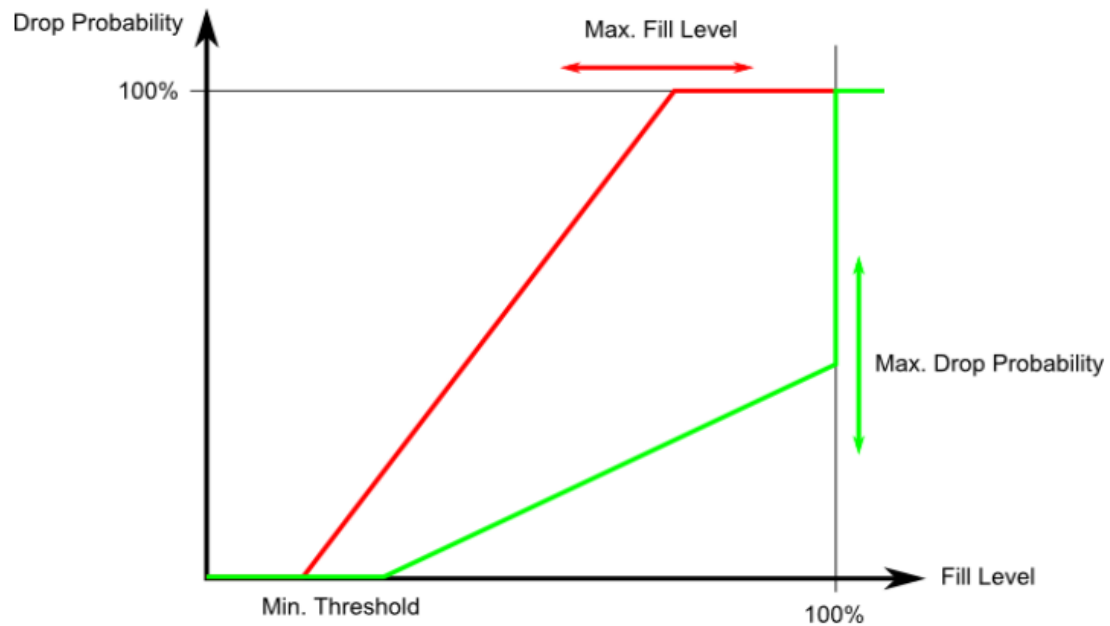

Min is the fill level where the queue randomly start dropping frames marked with Drop Precedence Level > 0 (yellow frames).

If Max Unit is 'Drop Probability' (the green line), Max controls the drop probability when the fill level is just below 100%.

If Max Unit is 'Fill Level' (the red line), Max controls the fill level where drop probability reaches 100%. This configuration makes it possible to reserve a portion of the queue exclusively for frames marked with Drop Precedence Level 0 (green frames). The reserved portion is calculated as $(100 - \text{Max}) \%$.

Frames marked with Drop Precedence Level 0 (green frames) are never dropped.

The drop probability for frames increases linearly from zero (at Min average queue filling level) to Max Drop Probability or Fill Level.

6.7 Multicast

5.7.1 IGMP Snooping

This page provides IGMP Snooping related configurations.

IGMP Snooping Configuration

Global Configuration	
Snooping Enabled	<input type="checkbox"/>
Unregistered IPMCv4 Flooding Enabled	<input checked="" type="checkbox"/>
IGMP SSM Range	232.0.0.0 / 8
Leave Proxy Enabled	<input type="checkbox"/>
Proxy Enabled	<input type="checkbox"/>

Port Related Configuration

Port	Router Port	Fast Leave	Throttling
*	<input type="checkbox"/>	<input type="checkbox"/>	<> ▼
1	<input type="checkbox"/>	<input type="checkbox"/>	unlimited ▼
2	<input type="checkbox"/>	<input type="checkbox"/>	unlimited ▼
3	<input type="checkbox"/>	<input type="checkbox"/>	unlimited ▼

Label	Description
Snooping Enabled	Check to enable global IGMP snooping
Unregistered IPMCv4 Flooding enabled	Enable unregistered IPMCv4 traffic flooding. The flooding control takes effect only when IGMP Snooping is enabled. When IGMP Snooping is disabled, unregistered IPMCv4 traffic flooding is always active in spite of this setting.
IGMP SSM Range	SSM (Source-Specific Multicast) Range allows the SSM-aware hosts and routers run the SSM service model for the groups in the address range. Assign valid IPv4 multicast address as prefix with a prefix length (from 4 to 32) for the range.
Leaver Proxy Enabled	Enable IGMP Leave Proxy. This feature can be used to avoid forwarding unnecessary leave messages to the router side.
Proxy Enable	Enable IGMP Proxy. This feature can be used to avoid forwarding unnecessary join and leave messages to the router side.
Router Port	Specifies which ports act as router ports. A router port is a port on the Ethernet switch that leads towards the Layer 3 multicast device or IGMP querier. If an aggregation member port is selected as a router port, the whole aggregation will act as a router port.
Fast Leave	Check to enable fast leave on the port

Throttling	Enable to limit the number of multicast groups to which a switch port can belong.
-------------------	---

VLAN Configurations of IGMP Snooping

Each page shows up to 99 entries from the VLAN table, with a default value of 20, selected by the **Entries Per Page** input field. When first visited, the web page will show the first 20 entries from the beginning of the VLAN Table. The first displayed will be the one with the lowest VLAN ID found in the VLAN Table.

The **VLAN** input field allows the user to select the starting point in the VLAN Table. Clicking the **Refresh** button will update the displayed table starting from that or the next closest VLAN Table match.

The **>>** will use the last entry of the currently displayed entry as a basis for the next lookup. When the end is reached, the text **No more entries** is shown in the displayed table. Use the **<<** button to start over.

IGMP Snooping VLAN Configuration

Refresh |<< >>

Start from VLAN 1 with 20 entries per page.

Delete	VLAN ID	Snooping Enabled	Querier Election	Querier Address	Compatibility	PRI	RV	QT (sec)	QRI (0.1 sec)	LLQI (0.1 sec)	URI (sec)
Delete		<input type="checkbox"/>	<input checked="" type="checkbox"/>	0.0.0.0	IGMP-Auto	0	2	125	100	10	1

Add New IGMP VLAN

Save Reset

Label	Description
Delete	Check to delete the entry. The designated entry will be deleted during the next save.
VLAN ID	The VLAN ID of the entry
IGMP Snooping Enable	Check to enable IGMP snooping for individual VLAN. Up to 32 VLANs can be selected.
Querier Election	Enable to join IGMP Querier election in the VLAN. Disable to act as an IGMP Non-Querier.
Querier Address	Define the IPv4 address as source address used in IP header for IGMP Querier election . When the Querier address is not set, system uses IPv4 management address of the IP interface associated with this VLAN. When the IPv4 management address is not set, system uses the first available IPv4 management address.

Compatibility	<p>Compatibility is maintained by hosts and routers taking appropriate actions depending on the versions of IGMP operating on hosts and routers within a network.</p> <p>The allowed selection is IGMP-Auto, Forced IGMPv1, Forced IGMPv2, Forced IGMPv3, default compatibility value is IGMP-Auto.</p>
PRI	<p>Priority of Interface.</p> <p>It indicates the IGMP control frame priority level generated by the system. These values can be used to prioritize different classes of traffic.</p> <p>The allowed range is 0 (best effort) to 7 (highest), default interface priority value is 0.</p>
RV	<p>Robustness Variable.</p> <p>The Robustness Variable allows tuning for the expected packet loss on a network.</p> <p>The allowed range is 1 to 255, default robustness variable value is 2.</p>
QI	<p>Query Interval.</p> <p>The Query Interval is the interval between General Queries sent by the Querier.</p> <p>The allowed range is 1 to 31744 seconds, default query interval is 125 seconds.</p>
QRI	<p>Query Response Interval.</p> <p>The Maximum Response Delay used to calculate the Maximum Response Code inserted into the periodic General Queries.</p> <p>The allowed range is 0 to 31744 in tenths of seconds, default query response interval is 100 in tenths of seconds (10 seconds).</p>
LLQI(LMQI for IGMP)	<p>Last Member Query Interval.</p> <p>The Last Member Query Time is the time value represented by the Last Member Query Interval, multiplied by the Last Member Query Count.</p> <p>The allowed range is 0 to 31744 in tenths of seconds, default last member query interval is 10 in tenths of seconds (1 second).</p>
URI	<p>Unsolicited Report Interval. The Unsolicited Report Interval is the time between repetitions of a host's initial report of membership in a group.</p> <p>The allowed range is 0 to 31744 seconds, default unsolicited report interval is 1 second.</p>

IGMP Snooping Status

This page provides IGMP snooping status.

Auto-refresh Refresh

IGMP Snooping Status

Statistics

VLAN ID	Querier Version	Host Version	Querier Status	Queries Transmitted	Queries Received	V1 Reports Received	V2 Reports Received	V3 Reports Received	V2 Leaves Received
Router Port									
Port	Status								
1	-								
2	-								
3	-								
4	-								

Label	Description
VLAN ID	The VLAN ID of the entry
Querier Version	Active Querier version
Host Version	Active Host version
Querier Status	Shows the Querier status as ACTIVE or IDLE
Querier Receive	The number of transmitted Querier
V1 Reports Receive	The number of received V1 reports
V2 Reports Receive	The number of received V2 reports
V3 Reports Receive	The number of received V3 reports
V2 Leave Receive	The number of received V2 leave packets
Refresh	Click to refresh the page immediately
Clear	Clear all statistics counters
Auto-refresh	Check to enable an automatic refresh of the page at regular intervals
Port	Switch port number
Status	Indicates whether a specific port is a router port or not

Groups Information of IGMP Snooping

Entries in the **IGMP Group Table** are shown on this page. The **IGMP Group Table** is sorted first by VLAN ID, and then by group.

IGMP Snooping Group Information

Auto-refresh Refresh |<< >>

Start from VLAN and group address with entries per page.

		Port Members																			
VLAN ID	Groups	1	2	3	4	5	6	7	8	9	10	11	12	13	14	15	16	17	18	19	20
No more entries																					

Label	Description
VLAN ID	The VLAN ID of the group
Groups	The group address of the group displayed
Port Members	Ports under this group

IPv4 SFM Information

Entries in the IGMP SFM Information Table are shown on this page. The IGMP SFM (Source-Filtered Multicast) Information Table also contains the SSM (Source-Specific Multicast) information. This table is sorted first by VLAN ID, then by group, and then by Port. Different source addresses belong to the same group are treated as single entry.

IGMP SFM Information

Auto-refresh Refresh |<< >>

Start from VLAN and Group with entries per page.

VLAN ID	Group	Port	Mode	Source Address	Type	Hardware Filter/Switch
No more entries						

Label	Description
VLAN ID	The VLAN ID of the group
Groups	The group address of the group displayed
Port	Switch port number.
Mode	Indicates the filtering mode maintained per (VLAN ID, port number, Group Address) basis. It can be either Include or Exclude.
Source Address	<p><u>IP</u> Address of the source.</p> <p>Currently, the maximum number of IPv4 source address for filtering (per group) is 8.</p> <p>When there is no any source filtering address, the text "None" is</p>

	shown in the Source Address field.
Type	Indicates the Type. It can be either Allow or Deny.
Hardware Filter / Switch	Indicates whether data plane destined to the specific group address from the source IPv4 address could be handled by chip or not.

Port Group Filtering

IGMP Snooping Port Filtering Profile Configuration

Port	Filtering Profile
1	- ▼
2	- ▼
3	- ▼
4	- ▼

Label	Description
Port	The logical port for the settings.
Filtering Profile	Select the <u>IPMC Profile</u> as the filtering condition for the specific port. Summary about the designated profile will be shown by clicking the view button.
Profile Management Button	You can inspect the rules of the designated profile by using the following button:  : List the rules associated with the designated profile.

6.8 Security

6.8.1 Device Binding

This page provides device binding configurations. Device binding is a powerful way to monitor devices and network security.

Device Binding									
Function State		Enable ▼							
Port	Mode	Alive Check		Stream Check		DDOS Prevention		Device	
		Active	Status	Active	Status	Active	Status	IP Address	MAC Address
1	Scan ▼	<input type="checkbox"/>	---	<input type="checkbox"/>	---	<input type="checkbox"/>	---	0.0.0.0	00-00-00-00-
2	Binding ▼	<input type="checkbox"/>	---	<input type="checkbox"/>	---	<input type="checkbox"/>	---	0.0.0.0	00-00-00-00-
3	Shutdown ▼	<input type="checkbox"/>	---	<input type="checkbox"/>	---	<input type="checkbox"/>	---	0.0.0.0	00-00-00-00-
4	--- ▼	<input type="checkbox"/>	---	<input type="checkbox"/>	---	<input type="checkbox"/>	---	0.0.0.0	00-00-00-00-
5	--- ▼	<input type="checkbox"/>	---	<input type="checkbox"/>	---	<input type="checkbox"/>	---	0.0.0.0	00-00-00-00-

Label	Description
Mode	Indicates the device binding operation for each port. Possible modes are: ---: disable Scan : scans IP/MAC automatically, but no binding function Binding : enables binding. Under this mode, any IP/MAC that does not match the entry will not be allowed to access the network. Shutdown : shuts down the port (No Link)
Alive Check Active	Check to enable alive check. When enabled, switch will ping the device continually.
Alive Check Status	Indicates alive check status. Possible statuses are: ---: disable Got Reply : receive ping reply from device, meaning the device is still alive Lost Reply : not receiving ping reply from device, meaning the device might have been dead.
Stream Check Active	Check to enable stream check. When enabled, the switch will detect the stream change (getting low) from the device.
Stream Check Status	Indicates stream check status. Possible statuses are: ---: disable Normal : the stream is normal. Low : the stream is getting low.
DDoS Prevention Acton	Check to enable DDOS prevention. When enabled, the switch will monitor the device against DDOS attacks.
DDoS Prevention Status	Indicates DDOS prevention status. Possible statuses are: ---: disable Analyzing : analyzes packet throughput for initialization Running : analysis completes and ready for next move Attacked : DDOS attacks occur
Device IP Address	Specifies IP address of the device
Device MAC Address	Specifies MAC address of the device

Advanced Configurations

Alias IP Address

This page provides Alias IP Address configuration. Some devices might have more than one IP addresses. You could specify the other IP address here.

Alias IP Address

Port	Alias IP Address
1	0.0.0.0
2	0.0.0.0
3	0.0.0.0
4	0.0.0.0
5	0.0.0.0
6	0.0.0.0
7	0.0.0.0

Label	Description
Alias IP Address	Specifies alias IP address. Keep 0.0.0.0 if the device does not have an alias IP address.

Alive Check

You can use ping commands to check port link status. If port link fails, you can set actions from the drop-down list.

Alive Check

Port	Mode	Action	Status
1	---	---	---
2	---	---	---
3	---	---	---
4	---	Link Change Only Log it Shunt Down the Port Reboot Device	---
5	---	---	---
6	---	---	---
7	---	---	---
8	---	---	---
9	---	---	---
10	---	---	---
11	---	---	---
12	---	---	---

Label	Description
Link Change	Disables or enables the port
Only log it	Simply sends logs to the log server
Shunt Down the Port	Disables the port
Reboot Device	Disables or enables PoE power

DDoS Prevention

This page provides DDOS Prevention configurations. The switch can monitor ingress packets, and perform actions when DDOS attack occurred on this port. You can configure the setting to achieve maximum protection.

DDOS Prevention

Port	Mode	Sensibility	Packet Type	Socket Number		Filter	Action	Status
				Low	High			
1	Enabled	Normal	TCP	80	80	Destination	---	Running...
2	---	Normal	TCP	80	80	Destination	---	---
3	---	Normal	TCP	80	80	Destination	---	---
4	---	Normal	TCP	80	80	Destination	---	---
5	---	Normal	TCP	80	80	Destination	---	---
6	---	Normal	TCP	80	80	Destination	---	---
7	---	Normal	TCP	80	80	Destination	---	---
8	---	Normal	TCP	80	80	Destination	---	---
9	---	Normal	TCP	80	80	Destination	---	---
10	---	Normal	TCP	80	80	Destination	---	---
11	---	Normal	TCP	80	80	Destination	---	---

Label	Description
Mode	Enables or disables DDOS prevention of the port
Sensibility	Indicates the level of DDOS detection. Possible levels are: Low: low sensibility Normal: normal sensibility Medium: medium sensibility High: high sensibility
Packet Type	Indicates the types of DDoS attack packets to be monitored. Possible types are: RX Total: all ingress packets RX Unicast: unicast ingress packets RX Multicast: multicast ingress packets RX Broadcast: broadcast ingress packets TCP: TCP ingress packets UDP: UDP ingress packets
Socket Number	If packet type is UDP (or TCP), please specify the socket number here. The socket number can be a range, from low to high. If the socket number is only one, please fill the same number in the low and high fields.
Filter	If packet type is UDP (or TCP), please choose the socket direction (Destination/Source).
Action	Indicates the action to take when DDOS attacks occur. Possible actions are: ---: no action Blocking 1 minute: blocks the forwarding for 1 minute and log the event Blocking 10 minute: blocks the forwarding for 10 minutes and

	<p>log the event</p> <p>Blocking: blocks and logs the event</p> <p>Shunt Down the Port: shuts down the port (No Link) and logs the event</p> <p>Only Log it: simply logs the event</p> <p>Reboot Device: if PoE is supported, the device can be rebooted. The event will be logged.</p>
Status	<p>Indicates the DDOS prevention status. Possible statuses are:</p> <p>---: disables DDOS prevention</p> <p>Analyzing: analyzes packet throughput for initialization</p> <p>Running: analysis completes and ready for next move</p> <p>Attacked: DDOS attacks occur</p>

Device Description

This page allows you to configure device description settings.

Device Description

Port	Device		
	Type	Location Address	Description
1	IP Camera		
2	IP Phone		
3	Access Point		
4	PC		
5	PLC		
6	Network Video Recorder		
7	---		
8	---		
9	---		
10	---		
11	---		
12	---		

Label	Description
Type	Indicates device types. Possible types are: --- (no specification), IP Camera , IP Phone , Access Point , PC , PLC , and Network Video Recorder
Location Address	Indicates location information of the device. The information can be used for Google Mapping.

Description	Device descriptions
--------------------	---------------------

Stream Check

This page allows you to configure stream check settings.

Stream Check

Port	Mode	Action	Status
1	---	---	---
2	---	---	---
3	---	---	---
4	---	---	---
5	---	---	---
6	---	---	---
7	---	---	---
8	---	---	---
9	---	---	---
10	---	---	---
11	---	---	---
12	---	---	---
13	---	---	---
14	---	---	---
15	---	---	---
16	---	---	---
17	---	---	---
18	---	---	---
19	---	---	---
20	---	---	---

Label	Description
Mode	Enables or disables stream monitoring of the port
Action	Indicates the action to take when the stream gets low. Possible actions are: ---: no action Log it: simply logs the event

6.8.2 Access Management Configuration

You can configure access management table on this page. If the application's type match any one of the access management entries, it will allow access to the switch.

Access Management Configuration

Mode Disabled ▾

Delete	VLAN ID	Start IP Address	End IP Address	HTTP/HTTPS	SNMP	TELNET/SSH
Delete	1	0.0.0.0	0.0.0.0	<input type="checkbox"/>	<input type="checkbox"/>	<input type="checkbox"/>

Add New Entry

Label	Description
--------------	-------------

Delete	Check to delete the entry. It will be deleted during the next save.
VLAN ID	The VLAN ID for the access management entry.
Start IP Address	The start IP address for the access management entry.
End IP Address	The end IP address for the access management entry.
HTTP/HTTPS	The host can access the switch from HTTP/HTTPS interface if the host IP address matches the IP address range provided in the entry.
SNMP	The host can access the switch from SNMP interface if the host IP address matches the IP address range provided in the entry.
TELNET/SSH	The host can access the switch from TELNET/SSH interface if the host IP address matches the IP address range provided in the entry.

Statistics

This page provides an overview of access management configurations.

Auto-refresh Refresh Clear

Access Management Statistics

Interface	Received Packets	Allowed Packets	Discarded Packets
HTTP	0	0	0
HTTPS	0	0	0
SNMP	0	0	0
TELNET	0	0	0
SSH	0	0	0

6.8.3 IP Source Guard

IP source guard can prevent traffic attacks if a host tries to use the IP address of its neighbor. You can enable IP source guard when DHCP snooping is enabled on an untrusted interface. With this function enabled, the switch blocks all IP traffic received on the interface except for DHCP packets allowed by DHCP snooping.

Configuration

IP Source Guard Configuration

Mode Disabled ▾

Translate dynamic to static

Port Mode Configuration

Port	Mode	Max Dynamic Clients
*	<> ▾	<> ▾
1	Disabled ▾	Unlimited ▾
2	Disabled ▾	Unlimited ▾
3	Disabled ▾	Unlimited ▾
4	Disabled ▾	Unlimited ▾
5	Disabled ▾	Unlimited ▾
6	Disabled ▾	Unlimited ▾

Label	Description
Mode	Enable or disable this function.
Max Dynamic Clients	Specify the number of clients supported.

Static Table

Static IP Source Guard Table

Delete	Port	VLAN ID	IP Address	MAC address
Delete	3 ▾			

Add New Entry

Save Reset

Label	Description
Delete	Check to delete the entry. It will be deleted during the next save.
Port	The logical port for the settings.
VLAN ID	The vlan id for the settings.
IP Address	Allowed Source IP address.
MAC Address	Allowed Source MAC address.

Dynamic Table

This page shows entries in the Dynamic IP Source Guard table. The default value is 20.

The Start from port address, VLAN, MAC address, and IP address input fields allow you to select the starting point in the table.

Dynamic IP Source Guard Table

Auto-refresh Refresh |<< >>

Start from Port 1 , VLAN 1 and IP address 0.0.0.0 with 20 entries per page.

Port	VLAN ID	IP Address	MAC Address
No more entries			

Label	Description
Port	The logical port for the settings.
VLAN ID	The vlan id for the settings.
IP Address	Allowed source IP address.
MAC Address	Allowed source MAC address.

6.8.4 ACL

Ports

This page allows you to configure the ACL parameters (ACE) of each switch port. These parameters will affect frames received on a port unless the frame matches a specific ACE.

ACL Ports Configuration

Refresh Clear

Port	Policy ID	Action	Rate Limiter ID	Port Redirect	Mirror	Logging	Shutdown	State	Counter
*	<input type="text" value="0"/>	<>	Disabled	Disabled Port 1 Port 2	<>	<>	<>	<>	*
1	<input type="text" value="0"/>	Permit	Disabled	Disabled Port 1 Port 2	Disabled	Disabled	Disabled	Enabled	0
2	<input type="text" value="0"/>	Permit	Disabled	Disabled Port 1 Port 2	Disabled	Disabled	Disabled	Enabled	0
3	<input type="text" value="0"/>	Permit	Disabled	Disabled Port 1 Port 2	Disabled	Disabled	Disabled	Enabled	0
4	<input type="text" value="0"/>	Permit	Disabled	Disabled Port 1 Port 2	Disabled	Disabled	Disabled	Enabled	0
5	<input type="text" value="0"/>	Permit	Disabled	Disabled Port 1 Port 2	Disabled	Disabled	Disabled	Enabled	979

Label	Description
Port	The switch port number to which the following settings will be applied
Policy ID	Select to apply a policy to the port. The allowed values are 1 to 8. The default value is 1 .
Action	Select to Permit to permit or Deny to deny forwarding. The default value is Permit .

Rate Limiter ID	Select a rate limiter for the port. The allowed values are Disabled or numbers from 1 to 15. The default value is Disabled .
Port Redirect	Indicates the port redirect operation implemented by the ACE. Frames matching the ACE are redirected to the listed port.
Mirror	Select which port frames are copied to. The allowed values are Disabled or a specific port number. The default value is Disabled .
Logging	Specifies the logging operation of the port. The allowed values are: Enabled : frames received on the port are stored in the system log Disabled : frames received on the port are not logged The default value is Disabled . Please note that system log memory capacity and logging rate is limited.
Shutdown	Specifies the shutdown operation of this port. The allowed values are: Enabled : if a frame is received on the port, the port will be disabled. Disabled : port shut down is disabled. The default value is Disabled .
Counter	Counts the number of frames that match this ACE.

Rate Limiters

This page allows you to configure the rate limiter for the ACL of the switch.

ACL Rate Limiter Configuration

Rate Limiter ID	Rate	Unit
*	10	<>
1	10	pps
2	10	pps
3	10	pps
4	10	pps
5	10	pps
6	10	pps
7	10	pps
8	10	pps
9	10	pps
10	10	pps
11	10	pps
12	10	pps
13	10	pps
14	10	pps
15	10	pps
16	10	pps

Save Reset

Label	Description
Rate Limiter ID	The rate limiter ID for the settings contained in the same row.
Rate	The rate unit is packet per second (pps), which can be configured as

	1, 2, 4, 8, 16, 32, 64, 128, 256, 512, 1K, 2K, 4K, 8K, 16K, 32K, 64K, 128K, 256K, 512K, or 1024K. The 1 kpps is actually 1002.1 pps.
Unit	Specify the unit for the rate.

ACL Control List

This page allows you to configure ACE (Access Control Entry). An ACE consists of several parameters. These parameters vary with the frame type you have selected. First select the ingress port for the ACE, and then the frame type. Different parameter options are displayed according to the frame type you have selected. A frame matching the ACE can be configured here.

ACE Configuration

<table border="1" style="width: 100%; border-collapse: collapse;"> <tr> <td style="background-color: #2c3e50; color: white; padding: 5px;">Ingress Port</td> <td style="padding: 5px;">All Port 1 Port 2 Port 3 Port 4</td> </tr> <tr> <td style="background-color: #2c3e50; color: white; padding: 5px;">Policy Filter</td> <td style="padding: 5px;">Any ▼</td> </tr> <tr> <td style="background-color: #2c3e50; color: white; padding: 5px;">Frame Type</td> <td style="padding: 5px;">Any ▼</td> </tr> </table>	Ingress Port	All Port 1 Port 2 Port 3 Port 4	Policy Filter	Any ▼	Frame Type	Any ▼	<table border="1" style="width: 100%; border-collapse: collapse;"> <tr> <td style="background-color: #2c3e50; color: white; padding: 5px;">Action</td> <td style="padding: 5px;">Permit ▼</td> </tr> <tr> <td style="background-color: #2c3e50; color: white; padding: 5px;">Rate Limiter</td> <td style="padding: 5px;">Disabled ▼</td> </tr> <tr> <td style="background-color: #2c3e50; color: white; padding: 5px;">Mirror</td> <td style="padding: 5px;">Disabled ▼</td> </tr> <tr> <td style="background-color: #2c3e50; color: white; padding: 5px;">Logging</td> <td style="padding: 5px;">Disabled ▼</td> </tr> <tr> <td style="background-color: #2c3e50; color: white; padding: 5px;">Shutdown</td> <td style="padding: 5px;">Disabled ▼</td> </tr> <tr> <td style="background-color: #2c3e50; color: white; padding: 5px;">Counter</td> <td style="padding: 5px;">0</td> </tr> </table>	Action	Permit ▼	Rate Limiter	Disabled ▼	Mirror	Disabled ▼	Logging	Disabled ▼	Shutdown	Disabled ▼	Counter	0
Ingress Port	All Port 1 Port 2 Port 3 Port 4																		
Policy Filter	Any ▼																		
Frame Type	Any ▼																		
Action	Permit ▼																		
Rate Limiter	Disabled ▼																		
Mirror	Disabled ▼																		
Logging	Disabled ▼																		
Shutdown	Disabled ▼																		
Counter	0																		

Label	Description
Ingress Port	<p>Indicates the ingress port to which the ACE will apply.</p> <p>Any: the ACE applies to any port</p> <p>Port n: the ACE applies to this port number, where n is the number of the switch port.</p> <p>Policy n: the ACE applies to this policy number, where n can range from 1 to 8.</p>
Frame Type	<p>Indicates the frame type of the ACE. These frame types are mutually exclusive.</p> <p>Any: any frame can match the ACE.</p> <p>Ethernet Type: only Ethernet type frames can match the ACE. The IEEE 802.3 describes the value of length/types should be greater than or equal to 1536 decimal (equal to 0600 hexadecimal).</p> <p>ARP: only ARP frames can match the ACE. Notice the ARP frames will not match the ACE with Ethernet type.</p> <p>IPv4: only IPv4 frames can match the ACE. Notice the IPv4 frames</p>

	will not match the ACE with Ethernet type.
Action	Specifies the action to take when a frame matches the ACE. Permit: takes action when the frame matches the ACE. Deny: drops the frame matching the ACE.
Rate Limiter	Specifies the rate limiter in number of base units. The allowed range is 1 to 15. Disabled means the rate limiter operation is disabled.
Port Copy	Frames matching the ACE are copied to the port number specified here. The allowed range is the same as the switch port number range. Disabled means the port copy operation is disabled.
Logging	Specifies the logging operation of the ACE. The allowed values are: Enabled : frames matching the ACE are stored in the system log. Disabled : frames matching the ACE are not logged. Please note that system log memory capacity and logging rate is limited.
Shutdown	Specifies the shutdown operation of the ACE. The allowed values are: Enabled : if a frame matches the ACE, the ingress port will be disabled. Disabled : port shutdown is disabled for the ACE.
Counter	Indicates the number of times the ACE matched by a frame.

MAC Parameters

SMAC Filter	Specific ▾
SMAC Value	00-00-00-00-00-0
DMAC Filter	Specific ▾
DMAC Value	00-00-00-00-00-0

Label	Description
SMAC Filter	(Only displayed when the frame type is Ethernet Type or ARP.) Specifies the source MAC filter for the ACE. Any : no SMAC filter is specified (SMAC filter status is "don't-care"). Specific : if you want to filter a specific source MAC address with the ACE, choose this value. A field for entering an SMAC value appears.
SMAC Value	When Specific is selected for the SMAC filter, you can enter a specific source MAC address. The legal format is

	"xx-xx-xx-xx-xx-xx". Frames matching the ACE will use this SMAC value.
DMAC Filter	<p>Specifies the destination MAC filter for this ACE</p> <p>Any: no DMAC filter is specified (DMAC filter status is "don't-care").</p> <p>MC: frame must be multicast.</p> <p>BC: frame must be broadcast.</p> <p>UC: frame must be unicast.</p> <p>Specific: If you want to filter a specific destination MAC address with the ACE, choose this value. A field for entering a DMAC value appears.</p>
DMAC Value	When Specific is selected for the DMAC filter, you can enter a specific destination MAC address. The legal format is "xx-xx-xx-xx-xx-xx". Frames matching the ACE will use this DMAC value.

VLAN Parameters

802.1Q Tagged	Any ▼
VLAN ID Filter	Specific ▼
VLAN ID	1
Tag Priority	4-7 ▼

Label	Description
VLAN ID Filter	<p>Specifies the VLAN ID filter for the ACE</p> <p>Any: no VLAN ID filter is specified (VLAN ID filter status is "don't-care").</p> <p>Specific: if you want to filter a specific VLAN ID with the ACE, choose this value. A field for entering a VLAN ID number appears.</p>
VLAN ID	When Specific is selected for the VLAN ID filter, you can enter a specific VLAN ID number. The allowed range is 1 to 4095. Frames matching the ACE will use this VLAN ID value.
Tag Priority	Specifies the tag priority for the ACE. A frame matching the ACE will use this tag priority. The allowed number range is 0 to 7. Any means that no tag priority is specified (tag priority is " don't-care ").

IP Parameters

IP Protocol Filter	Other ▾
IP Protocol Value	6
IP TTL	Non-zero ▾
IP Fragment	Yes ▾
IP Option	Yes ▾
SIP Filter	Network ▾
SIP Address	0.0.0.0
SIP Mask	0.0.0.0
DIP Filter	Network ▾
DIP Address	0.0.0.0
DIP Mask	0.0.0.0

Label	Description
IP Protocol Filter	<p>Specifies the IP protocol filter for the ACE</p> <p>Any: no IP protocol filter is specified ("don't-care").</p> <p>Specific: if you want to filter a specific IP protocol filter with the ACE, choose this value. A field for entering an IP protocol filter appears.</p> <p>ICMP: selects ICMP to filter IPv4 ICMP protocol frames. Extra fields for defining ICMP parameters will appear. For more details of these fields, please refer to the help file.</p> <p>UDP: selects UDP to filter IPv4 UDP protocol frames. Extra fields for defining UDP parameters will appear. For more details of these fields, please refer to the help file.</p> <p>TCP: selects TCP to filter IPv4 TCP protocol frames. Extra fields for defining TCP parameters will appear. For more details of these fields, please refer to the help file.</p>
IP Protocol Value	<p>Specific allows you to enter a specific value. The allowed range is 0 to 255. Frames matching the ACE will use this IP protocol value.</p>
IP TTL	<p>Specifies the time-to-live settings for the ACE</p> <p>Zero: IPv4 frames with a time-to-live value greater than zero must not be able to match this entry.</p> <p>Non-zero: IPv4 frames with a time-to-live field greater than zero must be able to match this entry.</p> <p>Any: any value is allowed ("don't-care").</p>

IP Fragment	<p>Specifies the fragment offset settings for the ACE. This includes settings of More Fragments (MF) bit and Fragment Offset (FRAG OFFSET) for an IPv4 frame.</p> <p>No: IPv4 frames whose MF bit is set or the FRAG OFFSET field is greater than zero must not be able to match this entry.</p> <p>Yes: IPv4 frames whose MF bit is set or the FRAG OFFSET field is greater than zero must be able to match this entry.</p> <p>Any: any value is allowed ("don't-care").</p>
IP Option	<p>Specifies the options flag settings for the ACE</p> <p>No: IPv4 frames whose options flag is set must not be able to match this entry.</p> <p>Yes: IPv4 frames whose options flag is set must be able to match this entry.</p> <p>Any: any value is allowed ("don't-care").</p>
SIP Filter	<p>Specifies the source IP filter for this ACE</p> <p>Any: no source IP filter is specified (Source IP filter is "don't-care").</p> <p>Host: source IP filter is set to Host. Specify the source IP address in the SIP Address field that appears.</p> <p>Network: source IP filter is set to Network. Specify the source IP address and source IP mask in the SIP Address and SIP Mask fields that appear.</p>
SIP Address	<p>When Host or Network is selected for the source IP filter, you can enter a specific SIP address in dotted decimal notation.</p>
SIP Mask	<p>When Network is selected for the source IP filter, you can enter a specific SIP mask in dotted decimal notation.</p>
DIP Filter	<p>Specifies the destination IP filter for the ACE</p> <p>Any: no destination IP filter is specified (destination IP filter is "don't-care").</p> <p>Host: destination IP filter is set to Host. Specify the destination IP address in the DIP Address field that appears.</p> <p>Network: destination IP filter is set to Network. Specify the destination IP address and destination IP mask in the DIP Address and DIP Mask fields that appear.</p>
DIP Address	<p>When Host or Network is selected for the destination IP filter, you can enter a specific DIP address in dotted decimal notation.</p>
DIP Mask	<p>When Network is selected for the destination IP filter, you can enter a specific DIP mask in dotted decimal notation.</p>

ARP Parameters

ARP/RARP	Other ▾	ARP SMAC Match	1 ▾
Request/Reply	Request ▾	RARP SMAC Match	1 ▾
Sender IP Filter	Network ▾	IP/Ethernet Length	Any ▾
Sender IP Address	192.168.1.1	IP	0 ▾
Sender IP Mask	255.255.255.0	Ethernet	1 ▾
Target IP Filter	Network ▾		
Target IP Address	192.168.1.254		
Target IP Mask	255.255.255.0		

Label	Description
ARP/RARP	<p>Specifies the available ARP/RARP opcode (OP) flag for the ACE</p> <p>Any: no ARP/RARP OP flag is specified (OP is "don't-care").</p> <p>ARP: frame must have ARP/RARP opcode set to ARP</p> <p>RARP: frame must have ARP/RARP opcode set to RARP.</p> <p>Other: frame has unknown ARP/RARP Opcode flag.</p>
Request/Reply	<p>Specifies the available ARP/RARP opcode (OP) flag for the ACE</p> <p>Any: no ARP/RARP OP flag is specified (OP is "don't-care").</p> <p>Request: frame must have ARP Request or RARP Request OP flag set.</p> <p>Reply: frame must have ARP Reply or RARP Reply OP flag.</p>
Sender IP Filter	<p>Specifies the sender IP filter for the ACE</p> <p>Any: no sender IP filter is specified (sender IP filter is "don't-care").</p> <p>Host: sender IP filter is set to Host. Specify the sender IP address in the SIP Address field that appears.</p> <p>Network: sender IP filter is set to Network. Specify the sender IP address and sender IP mask in the SIP Address and SIP Mask fields that appear.</p>
Sender IP Address	When Host or Network is selected for the sender IP filter, you can enter a specific sender IP address in dotted decimal notation.
Sender IP Mask	When Network is selected for the sender IP filter, you can enter a specific sender IP mask in dotted decimal notation.
Target IP Filter	Specifies the target IP filter for the specific ACE

	<p>Any: no target IP filter is specified (target IP filter is "don't-care").</p> <p>Host: target IP filter is set to Host. Specify the target IP address in the Target IP Address field that appears.</p> <p>Network: target IP filter is set to Network. Specify the target IP address and target IP mask in the Target IP Address and Target IP Mask fields that appear.</p>
Target IP Address	When Host or Network is selected for the target IP filter, you can enter a specific target IP address in dotted decimal notation.
Target IP Mask	When Network is selected for the target IP filter, you can enter a specific target IP mask in dotted decimal notation.
ARP SMAC Match	<p>Specifies whether frames will meet the action according to their sender hardware address field (SHA) settings.</p> <p>0: ARP frames where SHA is not equal to the SMAC address</p> <p>1: ARP frames where SHA is equal to the SMAC address</p> <p>Any: any value is allowed ("don't-care").</p>
RARP SMAC Match	<p>Specifies whether frames will meet the action according to their target hardware address field (THA) settings.</p> <p>0: RARP frames where THA is not equal to the SMAC address</p> <p>1: RARP frames where THA is equal to the SMAC address</p> <p>Any: any value is allowed ("don't-care")</p>
IP/Ethernet Length	<p>Specifies whether frames will meet the action according to their ARP/RARP hardware address length (HLN) and protocol address length (PLN) settings.</p> <p>0: ARP/RARP frames where the HLN is equal to Ethernet (0x06) and the (PLN) is equal to IPv4 (0x04) must not match this entry.</p> <p>1: ARP/RARP frames where the HLN is equal to Ethernet (0x06) and the (PLN) is equal to IPv4 (0x04) must match this entry.</p> <p>Any: any value is allowed ("don't-care").</p>
IP	<p>Specifies whether frames will meet the action according to their ARP/RARP hardware address space (HRD) settings.</p> <p>0: ARP/RARP frames where the HLD is equal to Ethernet (1) must not match this entry.</p> <p>1: ARP/RARP frames where the HLD is equal to Ethernet (1)</p>

	<p>must match this entry.</p> <p>Any: any value is allowed ("don't-care").</p>
Ethernet	<p>Specifies whether frames will meet the action according to their ARP/RARP protocol address space (PRO) settings.</p> <p>0: ARP/RARP frames where the PRO is equal to IP (0x800) must not match this entry.</p> <p>1: ARP/RARP frames where the PRO is equal to IP (0x800) must match this entry.</p> <p>Any: any value is allowed ("don't-care").</p>

ICMP Parameters

ICMP Type Filter	Specific
ICMP Type Value	255
ICMP Code Filter	Specific
ICMP Code Value	255

Label	Description
ICMP Type Filter	<p>Specifies the ICMP filter for the ACE</p> <p>Any: no ICMP filter is specified (ICMP filter status is "don't-care").</p> <p>Specific: if you want to filter a specific ICMP filter with the ACE, you can enter a specific ICMP value. A field for entering an ICMP value appears.</p>
ICMP Type Value	<p>When Specific is selected for the ICMP filter, you can enter a specific ICMP value. The allowed range is 0 to 255. A frame matching the ACE will use this ICMP value.</p>
ICMP Code Filter	<p>Specifies the ICMP code filter for the ACE</p> <p>Any: no ICMP code filter is specified (ICMP code filter status is "don't-care").</p> <p>Specific: if you want to filter a specific ICMP code filter with the ACE, you can enter a specific ICMP code value. A field for entering an ICMP code value appears.</p>
ICMP Code Value	<p>When Specific is selected for the ICMP code filter, you can enter a specific ICMP code value. The allowed range is 0 to 255. A frame matching the ACE will use this ICMP code value.</p>

TCP Parameters

Source Port Filter	Specific ▾
Source Port No.	0
Dest. Port Filter	Specific ▾
Dest. Port No.	80
TCP FIN	Any ▾
TCP SYN	Any ▾
TCP RST	Any ▾
TCP PSH	Any ▾
TCP ACK	Any ▾
TCP URG	Any ▾

UDP Parameters

Source Port Filter	Specific ▾
Source Port No.	0
Dest. Port Filter	Range ▾
Dest. Port Range	80 - 65535

Label	Description
TCP/UDP Source Filter	<p>Specifies the TCP/UDP source filter for the ACE</p> <p>Any: no TCP/UDP source filter is specified (TCP/UDP source filter status is "don't-care").</p> <p>Specific: if you want to filter a specific TCP/UDP source filter with the ACE, you can enter a specific TCP/UDP source value. A field for entering a TCP/UDP source value appears.</p> <p>Range: if you want to filter a specific TCP/UDP source range filter with the ACE, you can enter a specific TCP/UDP source range. A field for entering a TCP/UDP source value appears.</p>
TCP/UDP Source No.	<p>When Specific is selected for the TCP/UDP source filter, you can enter a specific TCP/UDP source value. The allowed range is 0 to 65535. A frame matching the ACE will use this TCP/UDP source value.</p>
TCP/UDP Source Range	<p>When Range is selected for the TCP/UDP source filter, you can enter a specific TCP/UDP source range value. The allowed range is 0 to 65535. A frame matching the ACE will use this TCP/UDP source value.</p>
TCP/UDP Destination Filter	<p>Specifies the TCP/UDP destination filter for the ACE</p> <p>Any: no TCP/UDP destination filter is specified (TCP/UDP destination filter status is "don't-care").</p> <p>Specific: if you want to filter a specific TCP/UDP destination filter with the ACE, you can enter a specific TCP/UDP destination value. A field for entering a TCP/UDP destination value appears.</p> <p>Range: if you want to filter a specific range TCP/UDP destination</p>

	filter with the ACE, you can enter a specific TCP/UDP destination range. A field for entering a TCP/UDP destination value appears.
TCP/UDP Destination Number	When Specific is selected for the TCP/UDP destination filter, you can enter a specific TCP/UDP destination value. The allowed range is 0 to 65535. A frame matching the ACE will use this TCP/UDP destination value.
TCP/UDP Destination Range	When Range is selected for the TCP/UDP destination filter, you can enter a specific TCP/UDP destination range value. The allowed range is 0 to 65535. A frame matching the ACE will use this TCP/UDP destination value.
TCP FIN	Specifies the TCP FIN ("no more data from sender") value for the ACE. 0 : TCP frames where the FIN field is set must not be able to match this entry. 1 : TCP frames where the FIN field is set must be able to match this entry. Any : any value is allowed (" don't-care ").
TCP SYN	Specifies the TCP SYN ("synchronize sequence numbers") value for the ACE 0 : TCP frames where the SYN field is set must not be able to match this entry. 1 : TCP frames where the SYN field is set must be able to match this entry. Any : any value is allowed (" don't-care ").
TCP PSH	Specifies the TCP PSH ("push function") value for the ACE 0 : TCP frames where the PSH field is set must not be able to match this entry. 1 : TCP frames where the PSH field is set must be able to match this entry. Any : any value is allowed (" don't-care ").
TCP ACK	Specifies the TCP ACK ("acknowledgment field significant") value for the ACE 0 : TCP frames where the ACK field is set must not be able to match this entry. 1 : TCP frames where the ACK field is set must be able to match this entry. Any : any value is allowed (" don't-care ").

TCP URG	<p>Specifies the TCP URG ("urgent pointer field significant") value for the ACE</p> <p>0: TCP frames where the URG field is set must not be able to match this entry.</p> <p>1: TCP frames where the URG field is set must be able to match this entry.</p> <p>Any: any value is allowed ("don't-care").</p>
----------------	--

6.8.5 AAA

Common Server Configurations

This page allows you to configure authentication servers.

RADIUS Server Configuration

Global Configuration

Timeout	5	seconds
Retransmit	3	times
Deadtime	0	minutes
Key	<input type="text"/>	
NAS-IP-Address	<input type="text"/>	
NAS-IPv6-Address	<input type="text"/>	
NAS-Identifier	<input type="text"/>	

Server Configuration

Delete	Hostname	Auth Port	Acct Port	Timeout	Retransmit	Key
Delete	<input type="text"/>	1812	1813	<input type="text"/>	<input type="text"/>	<input type="text"/>

Label	Description
Timeout	<p>The timeout, which can be set to a number between 3 and 3600 seconds, is the maximum time to wait for a reply from a server. If the server does not reply within this time frame, we will consider it to be dead and continue with the next enabled server (if any).</p> <p>RADIUS servers are using the UDP protocol, which is unreliable by design. In order to cope with lost frames, the timeout interval is divided into 3 subintervals of equal length. If a reply is not received within the subinterval, the request is transmitted again. This algorithm causes the RADIUS server to be queried up to 3 times before it is considered to be dead.</p>
Retransmit	<p>The number of times the switch tries to connect to a RADIUS server.</p>

Dead Time	The dead time, which can be set to a number between 0 and 3600 seconds, is the period during which the switch will not send new requests to a server that has failed to respond to a previous request. This will stop the switch from continually trying to contact a server that it has already determined as dead. Setting the dead time to a value greater than 0 (zero) will enable this feature, but only if more than one server has been configured.
NAS-IP-Address	Indicates the identifying IP Address of the NAS which is requesting authentication of the user, and SHOULD be unique to the NAS within the scope of the RADIUS server.
NAS-ID	Network Access Server identifier (NAS-ID) for the interface. The NAS-ID is sent to the RADIUS server by the controller (as a RADIUS client) using the authentication request, which is used to classify users to different groups. You can enter up to 32 alphanumeric characters.
Delete	Click to delete an entry from the table.
Hostname	Specifies the host name of the RADIUS server. The maximum supported length for the AAA RADIUS hostname is 40 characters.
Auth Port	The authentication port which specifies the UDP port used to connect the RADIUS server for authentication. The default is 1812.
Acct Port	The UDP port to use on the RADIUS accounting server. If the port is set to 0 (zero), the default port (1813) is used on the RADIUS accounting server.
Key	The shared secret between the switch and the RADIUS server.
Timeout	The time to wait for the RADIUS server to respond.
Retransmit	The number of times the switch tries to connect to a RADIUS server.

6.8.6 TACACS+

TACACS+ Server Configuration

Global Configuration

Timeout	5	seconds
Deadtime	0	minutes
Key		

Server Configuration

Delete	Hostname	Port	Timeout	Key
Delete		49		

Add New Server

Save Reset

Label	Description
Timeout	<p>The timeout, which can be set to a number between 3 and 3600 seconds, is the maximum time to wait for a reply from a server. If the server does not reply within this time frame, we will consider it to be dead and continue with the next enabled server (if any).</p> <p>TACACS+ servers are using the UDP protocol, which is unreliable by design. In order to cope with lost frames, the timeout interval is divided into 3 subintervals of equal length. If a reply is not received within the subinterval, the request is transmitted again. This algorithm causes the RADIUS server to be queried up to 3 times before it is considered to be dead.</p>
Dead Time	<p>The dead time, which can be set to a number between 0 and 3600 seconds, is the period during which the switch will not send new requests to a server that has failed to respond to a previous request. This will stop the switch from continually trying to contact a server that it has already determined as dead.</p> <p>Setting the dead time to a value greater than 0 (zero) will enable this feature, but only if more than one server has been configured.</p>
Key	The shared secret between the switch and the TACACS+ server.
Hostname	Specifies the host name of the TACACS+ server. The maximum supported length for the AAA RADIUS hostname is 40 characters.

Timeout	The time to wait for the TACACS+ server to respond.
Key	The shared secret between the switch and the TACACS+ server.

6.8.7 RADIUS

Authentication and Accounting Server Configurations

This page provides an overview of the status of the RADIUS servers configurable on the authentication configuration page.

RADIUS Server Status Overview					
Auto-refresh <input type="checkbox"/> Refresh					
#	IP Address	Authentication Port	Authentication Status	Accounting Port	Accounting Status
1			Disabled		Disabled
2			Disabled		Disabled
3			Disabled		Disabled
4			Disabled		Disabled
5			Disabled		Disabled

Label	Description
#	The RADIUS server number. Click to navigate to detailed statistics of the server
IP Address	The IP address and UDP port number (in <IP Address>:<UDP Port> notation) of the server
Status	<p>The current status of the server. This field has one of the following values:</p> <p>Disabled: the server is disabled.</p> <p>Not Ready: the server is enabled, but IP communication is not yet up and running.</p> <p>Ready: the server is enabled, IP communications are built, and the RADIUS module is ready to accept access attempts.</p> <p>Dead (X seconds left): access attempts are made to this server, but it does not reply within the configured timeout. The server has temporarily been disabled, but will be re-enabled when the dead-time expires. The number of seconds left before this occurs is displayed in parentheses. This state is only reachable when more than one server is enabled.</p>

RADIUS Details

This page shows the access statistics of the authentication and accounting servers. Use the server drop-down list to switch between the backend servers to show related details.

RADIUS Authentication Statistics for Server #2

Server #2 ▼	Auto-refresh <input type="checkbox"/>	Refresh	Clear
Receive Packets		Transmit Packets	
Access Accepts	0	Access Requests	0
Access Rejects	0	Access Retransmissions	0
Access Challenges	0	Pending Requests	0
Malformed Access Responses	0	Timeouts	0
Bad Authenticators	0		
Unknown Types	0		
Packets Dropped	0		
Other Info			
IP Address			
State			Disabled
Round-Trip Time			0 ms

RADIUS Accounting Statistics for Server #2

Receive Packets		Transmit Packets	
Responses	0	Requests	0
Malformed Responses	0	Retransmissions	0
Bad Authenticators	0	Pending Requests	0
Unknown Types	0	Timeouts	0
Packets Dropped	0		
Other Info			
IP Address			
State			Disabled
Round-Trip Time			0 ms

6.8.8 NAS (802.1x)

This page allows you to configure the IEEE 802.1X and MAC-based authentication system and port settings.

The IEEE 802.1X standard defines a port-based access control procedure that prevents unauthorized access to a network by requiring users to first submit credentials for authentication. One or more central servers (the backend servers) determine whether the user is allowed access to the network. These backend (RADIUS) servers are configured on the authentication configuration page.

MAC-based authentication allows for authentication of more than one user on the same port, and does not require the users to have special 802.1X software installed on their system. The switch uses the users' MAC addresses to authenticate against the backend server. As intruders can create counterfeit MAC addresses, MAC-based authentication is less secure than 802.1X authentication.

Overview of 802.1X (Port-Based) Authentication

In an 802.1X network environment, the user is called the supplicant, the switch is the authenticator, and the RADIUS server is the authentication server. The switch acts as the man-in-the-middle, forwarding requests and responses between the supplicant and the authentication server. Frames sent between the supplicant and the switch are special 802.1X frames, known as EAPOL (EAP Over LANs) frames which encapsulate EAP PDUs (RFC3748). Frames sent between the switch and the RADIUS server are RADIUS packets. RADIUS packets also encapsulate EAP PDUs together with other attributes like the switch's IP address, name, and the supplicant's port number on the switch. EAP is very flexible as it allows for different authentication methods, like MD5-Challenge, PEAP, and TLS. The important thing is that the authenticator (the switch) does not need to know which authentication method the supplicant and the authentication server are using, or how many information exchange frames are needed for a particular method. The switch simply encapsulates the EAP part of the frame into the relevant type (EAPOL or RADIUS) and forwards it.

When authentication is complete, the RADIUS server sends a special packet containing a success or failure indication. Besides forwarding the result to the supplicant, the switch uses it to open up or block traffic on the switch port connected to the supplicant.

Note: in an environment where two backend servers are enabled, the server timeout is configured to X seconds (using the authentication configuration page), and the first server in the list is currently down (but not considered dead), if the supplicant retransmits EAPOL Start frames at a rate faster than X seconds, it will never be authenticated because the switch will cancel on-going backend authentication server requests whenever it receives a new EAPOL Start frame from the supplicant. Since the server has not failed (because the X seconds have not expired), the same server will be contacted when the next backend authentication server request from the switch. This scenario will loop forever. Therefore, the server timeout should be smaller than the supplicant's EAPOL Start frame retransmission rate.

Overview of MAC-Based Authentication

Unlike 802.1X, MAC-based authentication is not a standard, but merely a best-practices method adopted by the industry. In MAC-based authentication, users are called clients, and the switch acts as the supplicant on behalf of clients. The initial frame (any kind of frame) sent by a client is snooped by the switch, which in turn uses the client's MAC address as both username and password in the subsequent EAP exchange with the RADIUS server. The 6-byte MAC address is converted to a string in the following form "xx-xx-xx-xx-xx-xx", that is, a dash (-) is used as separator between the lower-cased hexadecimal digits. The switch only supports the MD5-Challenge authentication method, so the RADIUS server must be

configured accordingly.

When authentication is complete, the RADIUS server sends a success or failure indication, which in turn causes the switch to open up or block traffic for that particular client, using static entries into the MAC Table. Only then will frames from the client be forwarded on the switch. There are no EAPOL frames involved in this authentication, and therefore, MAC-based authentication has nothing to do with the 802.1X standard.

The advantage of MAC-based authentication over 802.1X is that several clients can be connected to the same port (e.g. through a 3rd party switch or a hub) and still require individual authentication, and that the clients do not need special supplicant software to authenticate. The disadvantage is that MAC addresses can be spoofed by malicious users, equipment whose MAC address is a valid RADIUS user can be used by anyone, and only the MD5-Challenge method is supported.

802.1X and MAC-Based authentication configurations consist of two sections: system- and port-wide.

Refresh

Network Access Server Configuration

System Configuration

Mode	Disabled ▾
Reauthentication Enabled	<input type="checkbox"/>
Reauthentication Period	3600 seconds
EAPOL Timeout	30 seconds
Aging Period	300 seconds
Hold Time	10 seconds
RADIUS-Assigned QoS Enabled	<input type="checkbox"/>
RADIUS-Assigned VLAN Enabled	<input type="checkbox"/>
Guest VLAN Enabled	<input type="checkbox"/>
Guest VLAN ID	1
Max. Reauth. Count	2
Allow Guest VLAN if EAPOL Seen	<input type="checkbox"/>

Port Configuration

Port	Admin State	RADIUS-Assigned QoS Enabled	RADIUS-Assigned VLAN Enabled	Guest VLAN Enabled	Port State	Restart
*	Force Authorized ▾	<input type="checkbox"/>	<input type="checkbox"/>	<input type="checkbox"/>		
1	<> Force Authorized	<input type="checkbox"/>	<input type="checkbox"/>	<input type="checkbox"/>	Globally Disabled	Reauthenticate Reinitialize
2	Force Unauthorized Port-based 802.1X	<input type="checkbox"/>	<input type="checkbox"/>	<input type="checkbox"/>	Globally Disabled	Reauthenticate Reinitialize
3	Single 802.1X Multi 802.1X	<input type="checkbox"/>	<input type="checkbox"/>	<input type="checkbox"/>	Globally Disabled	Reauthenticate Reinitialize
4	MAC-based Auth.	<input type="checkbox"/>	<input type="checkbox"/>	<input type="checkbox"/>	Globally Disabled	Reauthenticate Reinitialize
5	Force Authorized ▾	<input type="checkbox"/>	<input type="checkbox"/>	<input type="checkbox"/>	Globally Disabled	Reauthenticate Reinitialize

Label	Description
Mode	Indicates if 802.1X and MAC-based authentication is globally enabled or disabled on the switch. If globally disabled, all ports are allowed to forward frames.
Reauthentication Enabled	If checked, clients are reauthenticated after the interval specified by the Reauthentication Period. Reauthentication for 802.1X-enabled ports can be used to detect if a new device is plugged into a switch port. For MAC-based ports, reauthentication is only useful if the

	<p>RADIUS server configuration has changed. It does not involve communication between the switch and the client, and therefore does not imply that a client is still present on a port (see Age Period below).</p>
Reauthentication Period	<p>Determines the period, in seconds, after which a connected client must be re-authenticated. This is only active if the Reauthentication Enabled checkbox is checked. Valid range of the value is 1 to 3600 seconds.</p>
EAPOL Timeout	<p>Determines the time for retransmission of Request Identity EAPOL frames.</p> <p>Valid range of the value is 1 to 65535 seconds. This has no effect for MAC-based ports.</p>
Age Period	<p>This setting applies to the following modes, i.e. modes using the Port Security functionality to secure MAC addresses:</p> <p>MAC-Based Auth.:</p> <p>When the NAS module uses the Port Security module to secure MAC addresses, the Port Security module needs to check for activity on the MAC address in question at regular intervals and free resources if no activity is seen within a given period of time. This parameter controls exactly this period and can be set to a number between 10 and 1000000 seconds.</p> <p>For ports in MAC-based Auth. mode, reauthentication does not cause direct communications between the switch and the client, so this will not detect whether the client is still attached or not, and the only way to free any resources is to age the entry.</p>
Hold Time	<p>This setting applies to the following modes, i.e. modes using the Port Security functionality to secure MAC addresses:</p> <p>MAC-Based Auth.:</p> <p>If a client is denied access - either because the RADIUS server denies the client access or because the RADIUS server request times out (according to the timeout specified on the "Configuration→Security→AAA" page) - the client is put on hold in Unauthorized state. The hold timer does not count during an on-going authentication.</p> <p>The switch will ignore new frames coming from the client during the hold time.</p> <p>The hold time can be set to a number between 10 and 1000000</p>

	seconds.
Port	The port number for which the configuration below applies
Admin State	<p>If NAS is globally enabled, this selection controls the port's authentication mode. The following modes are available:</p> <p>Force Authorized In this mode, the switch will send one EAPOL Success frame when the port link is up, and any client on the port will be allowed network access without authentication.</p> <p>Force Unauthorized In this mode, the switch will send one EAPOL Failure frame when the port link is up, and any client on the port will be disallowed network access.</p> <p>Port-based 802.1X In an 802.1X network environment, the user is called the supplicant, the switch is the authenticator, and the RADIUS server is the authentication server. The authenticator acts as the man-in-the-middle, forwarding requests and responses between the supplicant and the authentication server. Frames sent between the supplicant and the switch are special 802.1X frames, known as EAPOL (EAP Over LANs) frames which encapsulate EAP PDUs (RFC3748). Frames sent between the switch and the RADIUS server is RADIUS packets. RADIUS packets also encapsulate EAP PDUs together with other attributes like the switch's IP address, name, and the supplicant's port number on the switch. EAP is very flexible as it allows for different authentication methods, like MD5-Challenge, PEAP, and TLS. The important thing is that the authenticator (the switch) does not need to know which authentication method the supplicant and the authentication server are using, or how many information exchange frames are needed for a particular method. The switch simply encapsulates the EAP part of the frame into the relevant type (EAPOL or RADIUS) and forwards it.</p> <p>When authentication is complete, the RADIUS server sends a special packet containing a success or failure indication. Besides forwarding the result to the supplicant, the switch uses it to open up or block traffic on the switch port connected to the supplicant.</p>

Note: in an environment where two backend servers are enabled, the server timeout is configured to X seconds (using the authentication configuration page), and the first server in the list is currently down (but not considered dead), if the supplicant retransmits EAPOL Start frames at a rate faster than X seconds, it will never be authenticated because the switch will cancel on-going backend authentication server requests whenever it receives a new EAPOL Start frame from the supplicant. Since the server has not failed (because the X seconds have not expired), the same server will be contacted when the next backend authentication server request from the switch. This scenario will loop forever. Therefore, the server timeout should be smaller than the supplicant's EAPOL Start frame retransmission rate.

a. Single 802.1X

In port-based 802.1X authentication, once a supplicant is successfully authenticated on a port, the whole port is opened for network traffic. This allows other clients connected to the port (for instance through a hub) to piggy-back on the successfully authenticated client and get network access even though they are not authenticated individually. To overcome this security breach, use the Single 802.1X variant.

Single 802.1X is not yet an IEEE standard, but features many of the same characteristics as port-based 802.1X. In Single 802.1X, at most one supplicant can get authenticated on the port at a time. Normal EAPOL frames are used in the communications between the supplicant and the switch. If more than one supplicant are connected to a port, the one that comes first when the port's link is connected will be the first one considered. If that supplicant does not provide valid credentials within a certain amount of time, the chance will be given to another supplicant. Once a supplicant is successfully authenticated, only that supplicant will be allowed access. This is the most secure of all the supported modes. In this mode, the Port Security module is used to secure a supplicant's MAC address once successfully authenticated.

b. Multi 802.1X

In port-based 802.1X authentication, once a supplicant is successfully authenticated on a port, the whole port is opened for

network traffic. This allows other clients connected to the port (for instance through a hub) to piggy-back on the successfully authenticated client and get network access even though they are not authenticated individually. To overcome this security breach, use the Multi 802.1X variant.

Multi 802.1X is not yet an IEEE standard, but features many of the same characteristics as port-based 802.1X. In Multi 802.1X, one or more supplicants can be authenticated on the same port at the same time. Each supplicant is authenticated individually and secured in the MAC table using the Port Security module.

In Multi 802.1X it is not possible to use the multicast BPDU MAC address as the destination MAC address for EAPOL frames sent from the switch to the supplicant, since that would cause all supplicants attached to the port to reply to requests sent from the switch. Instead, the switch uses the supplicant's MAC address, which is obtained from the first EAPOL Start or EAPOL Response Identity frame sent by the supplicant. An exception to this is when no supplicants are attached. In this case, the switch sends EAPOL Request Identity frames using the BPDU multicast MAC address as destination - to wake up any supplicants that might be on the port.

The maximum number of supplicants that can be attached to a port can be limited using the Port Security Limit Control functionality.

MAC-based Auth.

Unlike port-based 802.1X, MAC-based authentication is not a standard, but merely a best-practices method adopted by the industry. In MAC-based authentication, users are called clients, and the switch acts as the supplicant on behalf of clients. The initial frame (any kind of frame) sent by a client is snooped by the switch, which in turn uses the client's MAC address as both username and password in the subsequent EAP exchange with the RADIUS server. The 6-byte MAC address is converted to a string in the following form "xx-xx-xx-xx-xx-xx", that is, a dash (-) is used as separator between the lower-cased hexadecimal digits. The switch only supports the MD5-Challenge authentication method, so the RADIUS server must be configured accordingly.

	<p>When authentication is complete, the RADIUS server sends a success or failure indication, which in turn causes the switch to open up or block traffic for that particular client, using the Port Security module. Only then will frames from the client be forwarded on the switch. There are no EAPOL frames involved in this authentication, and therefore, MAC-based authentication has nothing to do with the 802.1X standard.</p> <p>The advantage of MAC-based authentication over port-based 802.1X is that several clients can be connected to the same port (e.g. through a 3rd party switch or a hub) and still require individual authentication, and that the clients don't need special supplicant software to authenticate. The advantage of MAC-based authentication over 802.1X-based authentication is that the clients do not need special supplicant software to authenticate. The disadvantage is that MAC addresses can be spoofed by malicious users - equipment whose MAC address is a valid RADIUS user can be used by anyone. Also, only the MD5-Challenge method is supported. The maximum number of clients that can be attached to a port can be limited using the Port Security Limit Control functionality.</p>
Port State	<p>The current state of the port. It can undertake one of the following values:</p> <p>Globally Disabled: NAS is globally disabled.</p> <p>Link Down: NAS is globally enabled, but there is no link on the port.</p> <p>Authorized: the port is in Force Authorized or a single-supplicant mode and the supplicant is authorized.</p> <p>Unauthorized: the port is in Force Unauthorized or a single-supplicant mode and the supplicant is not successfully authorized by the RADIUS server.</p> <p>X Auth/Y Unauth: the port is in a multi-supplicant mode. Currently X clients are authorized and Y are unauthorized.</p>
Restart	<p>Two buttons are available for each row. The buttons are only enabled when authentication is globally enabled and the port's Admin State is in an EAPOL-based or MAC-based mode.</p> <p>Clicking these buttons will not cause settings changed on the page to take effect.</p>

	<p>Reauthenticate: schedules a reauthentication whenever the quiet-period of the port runs out (EAPOL-based authentication). For MAC-based authentication, reauthentication will be attempted immediately.</p> <p>The button only has effect on successfully authenticated clients on the port and will not cause the clients to be temporarily unauthorized.</p> <p>Reinitialize: forces a reinitialization of the clients on the port and hence a reauthentication immediately. The clients will transfer to the unauthorized state while the reauthentication is in progress.</p>
--	--

Switch

This page provides an overview of the current NAS port states.

Network Access Server Switch Status						
Auto-refresh <input type="checkbox"/> Refresh						
Port	Admin State	Port State	Last Source	Last ID	QoS Class	Port VLAN ID
1	Force Authorized	Globally Disabled			-	
2	Force Authorized	Globally Disabled			-	
3	Force Authorized	Globally Disabled			-	
4	Force Authorized	Globally Disabled			-	
5	Force Authorized	Globally Disabled			-	

Label	Description
Port	The switch port number. Click to navigate to detailed 802.1X statistics of each port.
Admin State	The port's current administrative state. Refer to NAS Admin State for more details regarding each value.
Port State	The current state of the port. Refer to NAS Port State for more details regarding each value.
Last Source	The source MAC address carried in the most recently received EAPOL frame for EAPOL-based authentication, and the most recently received frame from a new client for MAC-based authentication.
Last ID	The user name (supplicant identity) carried in the most recently received Response Identity EAPOL frame for EAPOL-based authentication, and the source MAC address from the most recently received frame from a new client for MAC-based authentication.
QoS Class	Shows the level of QoS.

This page provides detailed IEEE 802.1X statistics for a specific switch port using port-based authentication. For MAC-based ports, only selected backend server (RADIUS Authentication Server) statistics is showed. Use the port drop-down list to select which port details to be displayed.

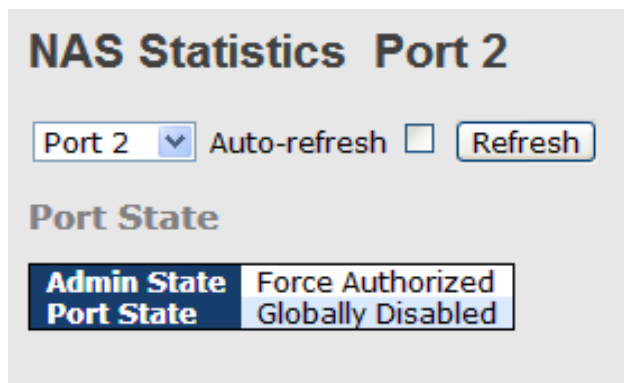

Label	Description																																																
Admin State	The port's current administrative state. Refer to NAS Admin State for more details regarding each value.																																																
Port State	The current state of the port. Refer to NAS Port State for more details regarding each value.																																																
EAPOL Counters	<p>These supplicant frame counters are available for the following administrative states:</p> <ul style="list-style-type: none"> • Force Authorized • Force Unauthorized • 802.1X <table border="1"> <thead> <tr> <th colspan="4">EAPOL Counters</th> </tr> <tr> <th>Direction</th> <th>Name</th> <th>IEEE Name</th> <th>Description</th> </tr> </thead> <tbody> <tr> <td>Rx</td> <td>Total</td> <td>dot1xAuthEapolFramesRx</td> <td>The number of valid EAPOL frames of any type that have been received by the switch.</td> </tr> <tr> <td>Rx</td> <td>Response ID</td> <td>dot1xAuthEapolRespIdFramesRx</td> <td>The number of valid EAP Resp/ID frames that have been received by the switch.</td> </tr> <tr> <td>Rx</td> <td>Responses</td> <td>dot1xAuthEapolRespFramesRx</td> <td>The number of valid EAPOL response frames (other than Resp/ID frames) that have been received by the switch.</td> </tr> <tr> <td>Rx</td> <td>Start</td> <td>dot1xAuthEapolStartFramesRx</td> <td>The number of EAPOL Start frames that have been received by the switch.</td> </tr> <tr> <td>Rx</td> <td>Logoff</td> <td>dot1xAuthEapolLogoffFramesRx</td> <td>The number of valid EAPOL logoff frames that have been received by the switch.</td> </tr> <tr> <td>Rx</td> <td>Invalid Type</td> <td>dot1xAuthInvalidEapolFramesRx</td> <td>The number of EAPOL frames that have been received by the switch in which the frame type is not recognized.</td> </tr> <tr> <td>Rx</td> <td>Invalid Length</td> <td>dot1xAuthEapLengthErrorFramesRx</td> <td>The number of EAPOL frames that have been received by the switch in which the Packet Body Length field is invalid.</td> </tr> <tr> <td>Tx</td> <td>Total</td> <td>dot1xAuthEapolFramesTx</td> <td>The number of EAPOL frames of any type that have been transmitted by the switch.</td> </tr> <tr> <td>Tx</td> <td>Request ID</td> <td>dot1xAuthEapolReqIdFramesTx</td> <td>The number of EAP initial request frames that have been transmitted by the switch.</td> </tr> <tr> <td>Tx</td> <td>Requests</td> <td>dot1xAuthEapolReqFramesTx</td> <td>The number of valid EAP Request frames (other than initial request frames) that have been transmitted by the switch.</td> </tr> </tbody> </table>	EAPOL Counters				Direction	Name	IEEE Name	Description	Rx	Total	dot1xAuthEapolFramesRx	The number of valid EAPOL frames of any type that have been received by the switch.	Rx	Response ID	dot1xAuthEapolRespIdFramesRx	The number of valid EAP Resp/ID frames that have been received by the switch.	Rx	Responses	dot1xAuthEapolRespFramesRx	The number of valid EAPOL response frames (other than Resp/ID frames) that have been received by the switch.	Rx	Start	dot1xAuthEapolStartFramesRx	The number of EAPOL Start frames that have been received by the switch.	Rx	Logoff	dot1xAuthEapolLogoffFramesRx	The number of valid EAPOL logoff frames that have been received by the switch.	Rx	Invalid Type	dot1xAuthInvalidEapolFramesRx	The number of EAPOL frames that have been received by the switch in which the frame type is not recognized.	Rx	Invalid Length	dot1xAuthEapLengthErrorFramesRx	The number of EAPOL frames that have been received by the switch in which the Packet Body Length field is invalid.	Tx	Total	dot1xAuthEapolFramesTx	The number of EAPOL frames of any type that have been transmitted by the switch.	Tx	Request ID	dot1xAuthEapolReqIdFramesTx	The number of EAP initial request frames that have been transmitted by the switch.	Tx	Requests	dot1xAuthEapolReqFramesTx	The number of valid EAP Request frames (other than initial request frames) that have been transmitted by the switch.
EAPOL Counters																																																	
Direction	Name	IEEE Name	Description																																														
Rx	Total	dot1xAuthEapolFramesRx	The number of valid EAPOL frames of any type that have been received by the switch.																																														
Rx	Response ID	dot1xAuthEapolRespIdFramesRx	The number of valid EAP Resp/ID frames that have been received by the switch.																																														
Rx	Responses	dot1xAuthEapolRespFramesRx	The number of valid EAPOL response frames (other than Resp/ID frames) that have been received by the switch.																																														
Rx	Start	dot1xAuthEapolStartFramesRx	The number of EAPOL Start frames that have been received by the switch.																																														
Rx	Logoff	dot1xAuthEapolLogoffFramesRx	The number of valid EAPOL logoff frames that have been received by the switch.																																														
Rx	Invalid Type	dot1xAuthInvalidEapolFramesRx	The number of EAPOL frames that have been received by the switch in which the frame type is not recognized.																																														
Rx	Invalid Length	dot1xAuthEapLengthErrorFramesRx	The number of EAPOL frames that have been received by the switch in which the Packet Body Length field is invalid.																																														
Tx	Total	dot1xAuthEapolFramesTx	The number of EAPOL frames of any type that have been transmitted by the switch.																																														
Tx	Request ID	dot1xAuthEapolReqIdFramesTx	The number of EAP initial request frames that have been transmitted by the switch.																																														
Tx	Requests	dot1xAuthEapolReqFramesTx	The number of valid EAP Request frames (other than initial request frames) that have been transmitted by the switch.																																														
Backend Server Counters	<p>These backend (RADIUS) frame counters are available for the following administrative states:</p> <ul style="list-style-type: none"> • 802.1X 																																																

	<p>• MAC-based Auth.</p> <table border="1"> <thead> <tr> <th colspan="4">Backend Server Counters</th> </tr> <tr> <th>Direction</th> <th>Name</th> <th>IEEE Name</th> <th>Description</th> </tr> </thead> <tbody> <tr> <td>Rx</td> <td>Access Challenges</td> <td>dot1xAuthBackendAccessChallenges</td> <td>Port-based: Counts the number of times that the switch receives the first request from the backend server following the first response from the supplicant. Indicates that the backend server has communication with the switch. MAC-based: Counts all Access Challenges received from the backend server for this port (left-most table) or client (right-most table).</td> </tr> <tr> <td>Rx</td> <td>Other Requests</td> <td>dot1xAuthBackendOtherRequestsToSupplicant</td> <td>Port-based: Counts the number of times that the switch sends an EAP Request packet following the first to the supplicant. Indicates that the backend server chose an EAP-method. MAC-based: Not applicable.</td> </tr> <tr> <td>Rx</td> <td>Auth. Successes</td> <td>dot1xAuthBackendAuthSuccesses</td> <td>Port- and MAC-based: Counts the number of times that the switch receives a success indication. Indicates that the supplicant/client has successfully authenticated to the backend server.</td> </tr> <tr> <td>Rx</td> <td>Auth. Failures</td> <td>dot1xAuthBackendAuthFails</td> <td>Port- and MAC-based: Counts the number of times that the switch receives a failure message. This indicates that the supplicant/client has not authenticated to the backend server.</td> </tr> <tr> <td>Tx</td> <td>Responses</td> <td>dot1xAuthBackendResponses</td> <td>Port-based: Counts the number of times that the switch attempts to send a supplicant's first response packet to the backend server. Indicates the switch attempted communication with the backend server. Possible retransmissions are not counted. MAC-based: Counts all the backend server packets sent from the switch towards the backend server for a given port (left-most table) or client (right-most table). Possible retransmissions are not counted.</td> </tr> </tbody> </table>	Backend Server Counters				Direction	Name	IEEE Name	Description	Rx	Access Challenges	dot1xAuthBackendAccessChallenges	Port-based: Counts the number of times that the switch receives the first request from the backend server following the first response from the supplicant. Indicates that the backend server has communication with the switch. MAC-based: Counts all Access Challenges received from the backend server for this port (left-most table) or client (right-most table).	Rx	Other Requests	dot1xAuthBackendOtherRequestsToSupplicant	Port-based: Counts the number of times that the switch sends an EAP Request packet following the first to the supplicant. Indicates that the backend server chose an EAP-method. MAC-based: Not applicable.	Rx	Auth. Successes	dot1xAuthBackendAuthSuccesses	Port- and MAC-based: Counts the number of times that the switch receives a success indication. Indicates that the supplicant/client has successfully authenticated to the backend server.	Rx	Auth. Failures	dot1xAuthBackendAuthFails	Port- and MAC-based: Counts the number of times that the switch receives a failure message. This indicates that the supplicant/client has not authenticated to the backend server.	Tx	Responses	dot1xAuthBackendResponses	Port-based: Counts the number of times that the switch attempts to send a supplicant's first response packet to the backend server. Indicates the switch attempted communication with the backend server. Possible retransmissions are not counted. MAC-based: Counts all the backend server packets sent from the switch towards the backend server for a given port (left-most table) or client (right-most table). Possible retransmissions are not counted.
Backend Server Counters																													
Direction	Name	IEEE Name	Description																										
Rx	Access Challenges	dot1xAuthBackendAccessChallenges	Port-based: Counts the number of times that the switch receives the first request from the backend server following the first response from the supplicant. Indicates that the backend server has communication with the switch. MAC-based: Counts all Access Challenges received from the backend server for this port (left-most table) or client (right-most table).																										
Rx	Other Requests	dot1xAuthBackendOtherRequestsToSupplicant	Port-based: Counts the number of times that the switch sends an EAP Request packet following the first to the supplicant. Indicates that the backend server chose an EAP-method. MAC-based: Not applicable.																										
Rx	Auth. Successes	dot1xAuthBackendAuthSuccesses	Port- and MAC-based: Counts the number of times that the switch receives a success indication. Indicates that the supplicant/client has successfully authenticated to the backend server.																										
Rx	Auth. Failures	dot1xAuthBackendAuthFails	Port- and MAC-based: Counts the number of times that the switch receives a failure message. This indicates that the supplicant/client has not authenticated to the backend server.																										
Tx	Responses	dot1xAuthBackendResponses	Port-based: Counts the number of times that the switch attempts to send a supplicant's first response packet to the backend server. Indicates the switch attempted communication with the backend server. Possible retransmissions are not counted. MAC-based: Counts all the backend server packets sent from the switch towards the backend server for a given port (left-most table) or client (right-most table). Possible retransmissions are not counted.																										
<p>Last Supplicant/Client Info</p>	<p>Information about the last supplicant/client that attempts to authenticate. This information is available for the following administrative states:</p> <ul style="list-style-type: none"> • 802.1X • MAC-based Auth. <table border="1"> <thead> <tr> <th colspan="3">Last Supplicant/Client Info</th> </tr> <tr> <th>Name</th> <th>IEEE Name</th> <th>Description</th> </tr> </thead> <tbody> <tr> <td>MAC Address</td> <td>dot1xAuthLastEapolFrameSource</td> <td>The MAC address of the last supplicant/client.</td> </tr> <tr> <td>VLAN ID</td> <td>-</td> <td>The VLAN ID on which the last frame from the last supplicant/client was received. 802.1X-based: The protocol version number carried in the most recently received EAPOL frame.</td> </tr> <tr> <td>Version</td> <td>dot1xAuthLastEapolFrameVersion</td> <td>MAC-based: Not applicable.</td> </tr> <tr> <td>Identity</td> <td>-</td> <td>802.1X-based: The user name (supplicant identity) carried in the most recently received Response Identity EAPOL frame. MAC-based: Not applicable.</td> </tr> </tbody> </table>	Last Supplicant/Client Info			Name	IEEE Name	Description	MAC Address	dot1xAuthLastEapolFrameSource	The MAC address of the last supplicant/client.	VLAN ID	-	The VLAN ID on which the last frame from the last supplicant/client was received. 802.1X-based: The protocol version number carried in the most recently received EAPOL frame.	Version	dot1xAuthLastEapolFrameVersion	MAC-based: Not applicable.	Identity	-	802.1X-based: The user name (supplicant identity) carried in the most recently received Response Identity EAPOL frame. MAC-based: Not applicable.										
Last Supplicant/Client Info																													
Name	IEEE Name	Description																											
MAC Address	dot1xAuthLastEapolFrameSource	The MAC address of the last supplicant/client.																											
VLAN ID	-	The VLAN ID on which the last frame from the last supplicant/client was received. 802.1X-based: The protocol version number carried in the most recently received EAPOL frame.																											
Version	dot1xAuthLastEapolFrameVersion	MAC-based: Not applicable.																											
Identity	-	802.1X-based: The user name (supplicant identity) carried in the most recently received Response Identity EAPOL frame. MAC-based: Not applicable.																											

6.8.9 ARP Inspection

This page allows you to configure the Random Early Detection (RED) settings.

Through different RED configuration for the queues (QoS classes) it is possible to obtain Weighted Random Early Detection (WRED) operation between queues.

The settings are global for all ports in the switch.

Weighted Random Early Detection Configuration

Group	Queue	DPL	Enable	Min	Max	Max Unit
1	0	1	<input type="checkbox"/>	0	50	Drop Probability ▼
1	0	2	<input type="checkbox"/>	0	50	Drop Probability ▼
1	0	3	<input type="checkbox"/>	0	50	Drop Probability ▼
1	1	1	<input type="checkbox"/>	0	50	Drop Probability ▼
1	1	2	<input type="checkbox"/>	0	50	Drop Probability ▼
1	1	3	<input type="checkbox"/>	0	50	Drop Probability ▼
1	2	1	<input type="checkbox"/>	0	50	Drop Probability ▼

Label	Description
Group	The WRED group number for which the configuration below applies.
Queue	The queue number (QoS class) for which the configuration below applies.
DPL	The Drop Precedence Level for which the configuration below applies.
Enable	Controls whether RED is enabled for this entry.
Min	Controls the lower RED fill level threshold. If the queue filling level is below this threshold, the drop probability is zero. This value is restricted to 0-100%.
Max	Controls the upper RED drop probability or fill level threshold for frames marked with Drop Precedence Level > 0 (yellow frames). This value is restricted to 1-100%.
Max Unit	Selects the unit for Max. Possible values are: Drop Probability: Max controls the drop probability just below 100% fill level. Fill Level: Max controls the fill level where drop probability reaches 100%.

6.8.10 Port Security

Limit Control

This page allows you to configure limit control for port security system- or port-wise. It will limit the number of users on a given port. If the specified number is exceeded, an action is taken..

System Configuration

Mode	Disabled ▼
Aging Enabled	<input type="checkbox"/>
Aging Period	3600 seconds

Label	Description
Mode	Indicates if Limit Control is globally enabled or disabled on the switch. If globally disabled, other modules may still use the underlying functionality, but limit checks and corresponding actions are disabled.
Aging Enabled	If checked, secured MAC addresses are subject to aging as discussed under Aging Period.
Aging Period	You can specify the aging period in seconds. The Aging Period can be set to a number between 10 and 10,000,000 seconds.

Port Configuration

Port	Mode	Limit	Action	State	Re-open
*	<> ▼	4	<> ▼		
1	Disabled ▼	4	None ▼	Disabled	Reopen
2	Disabled ▼	4	None ▼	Disabled	Reopen
3	Disabled ▼	4	None ▼	Disabled	Reopen

Label	Description
Mode	Controls whether Limit Control is enabled on this port. Both this and the Global Mode must be set to Enabled for Limit Control to be in effect. Notice that other modules may still use the underlying port security features without enabling Limit Control on a given port.
Limit	The maximum number of MAC addresses that can be secured on this port. The maximum allowed value is 1024. If the limit is

	exceeded, the corresponding action is taken.
Action	<p>If the limit number is reached, the switch will take one of the following actions:</p> <p>None: Do not allow more than Limit MAC addresses on the port, but take no further action.</p> <p>Trap: If Limit + 1 MAC addresses is seen on the port, send an <i>SNMP (Simple Network Management Protocol)</i> trap. If Aging is disabled, only one SNMP trap will be sent, but with Aging enabled, new SNMP traps will be sent every time the limit gets exceeded.</p> <p>Shutdown: If Limit + 1 MAC addresses is seen on the port, shut down the port. This implies that all secured MAC addresses will be removed from the port, and no new address will be learned. Even if the link is physically disconnected and reconnected on the port (by disconnecting the cable), the port will remain shut down.</p> <p>Trap & Shutdown: If Limit + 1 MAC addresses is seen on the port, both the “Trap” and the “Shutdown” actions described above will be taken.</p>
State	<p>This column shows the current state of the port as seen from the Limit Control's point of view. The state takes one of four values:</p> <p>Disabled: Limit Control is either globally disabled or disabled on the port.</p> <p>Ready: The limit is not yet reached. This can be shown for all actions.</p> <p>Limit Reached: Indicates that the limit is reached on this port. This state can only be shown if Action is set to None or Trap.</p> <p>Shutdown: Indicates that the port is shut down by the Limit Control module. This state can only be shown if Action is set to Shutdown or Trap & Shutdown.</p>
Re-open	<p>If a port is shut down by this module, you may reopen it by clicking this button, which will only be enabled if this is the case.</p> <p>Note that clicking the Re-open button causes the page to be refreshed, so non-committed changes will be lost.</p>

Switch

This page allows you to review the port security status.

Port Security Switch Status

Auto-refresh

User Module Legend

User Module Name	Abbr
Limit Control	L
802.1X	8

Label	Description
User Module Name	The full name of a module that may request Port Security services.
Abbr	A one-letter abbreviation of the user module. This is used in the Users column in the port status table.

Port Status

Port	Users	State	MAC Count	
			Current	Limit
1	--	Disabled	-	-
2	--	Disabled	-	-
3	--	Disabled	-	-
4	--	Disabled	-	-
5	--	Disabled	-	-

Label	Description
Users	Each of the user modules has a column that shows whether that module has enabled Port Security or not. A '-' means that the corresponding user module is not enabled, whereas a letter indicates that the user module abbreviated by that letter (see Abbr) has enabled port security.
State	Shows the current state of the port which includes the following values: Disabled: No user modules are currently using the Port Security

	<p>service.</p> <p>Ready: The Port Security service is in use by at least one user module, and is awaiting frames from unknown MAC addresses to arrive.</p> <p>Limit Reached: The Port Security service is enabled by at least the Limit Control user module, and that module has indicated that the limit is reached and no more MAC addresses should be taken in.</p> <p>Shutdown: The Port Security service is enabled by at least the Limit Control user module, and that module has indicated that the limit is exceeded. No MAC addresses can be learned on the port until it is administratively re-opened on the Limit Control configuration Web-page.</p>
MAC Count	<p>The two columns indicate the number of currently learned MAC addresses (forwarding as well as blocked) and the maximum number of MAC addresses that can be learned on the port, respectively. If no user modules are enabled on the port, the Current column will show a dash (-). If the Limit Control user module is not enabled on the port, the Limit column will show a dash (-).</p>

Port

This page allows you to review the MAC addresses secured by the Port Security module.

Port Security Port Status Port 1

Port 1 ▼
Auto-refresh
Refresh

MAC Address	VLAN ID	State	Time of Addition	Age/Hold
No MAC addresses attached				

Label	Description
MAC Address	The MAC address that is seen on this port. If no MAC addresses are learned, a single row stating No MAC addresses attached is displayed.
VLAN ID	The VLAN ID that is seen on this port.
State	Indicates whether the corresponding MAC address is blocked or forwarding. If blocked, it will not be allowed to transmit or receive traffic.

Time of Addition	Shows the date and time when this MAC address was first seen on the port.
Age/Hold	<p>If at least one user module has decided to block this MAC address, it will stay in the blocked state until the hold time (measured in seconds) expires. If all user modules have decided to allow this MAC address to forward, and aging is enabled, the Port Security module will periodically check that this MAC address still forwards traffic.</p> <p>If the age period (measured in seconds) expires and no frames have been seen, the MAC address will be removed from the MAC table. Otherwise a new age period will begin.</p> <p>If aging is disabled or a user module has decided to hold the MAC address indefinitely, a dash (-) will be shown.</p>

6.9 Warning

6.9.1 Fault Alarm

When any selected fault event happens, the Fault LED on the switch panel will light up and the electric relay will signal at the same time.

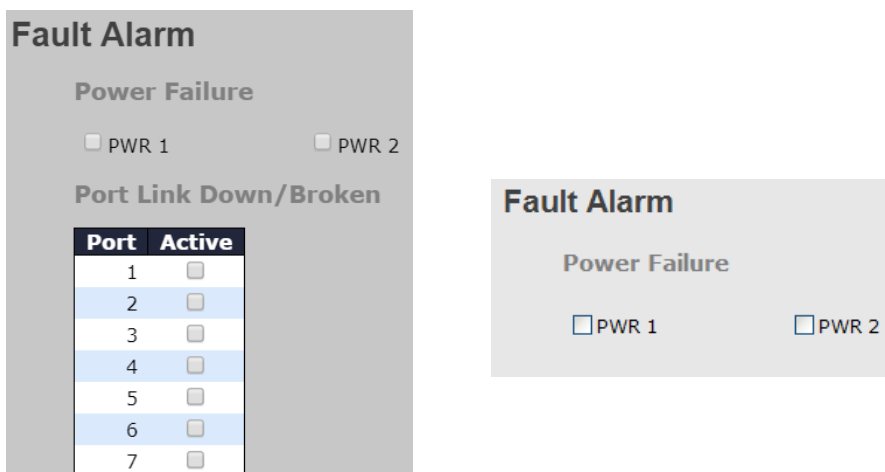

6.9.2 System Warning

SYSLOG Setting

The SYSLOG is a protocol that transmits event notifications across networks.

System Log Configuration

Server Mode	Disabled ▼
Server Address	
Syslog Level	Informational ▼ Error Warning Notice Informational

Label	Description
Server Mode	<p>Indicates existing server mode. When the mode operation is enabled, the syslog message will be sent to syslog server. The syslog protocol is based on UDP communications and received on UDP port 514 and the syslog server will not send acknowledgments back to the sender since UDP is a connectionless protocol and it does not provide acknowledgments. The syslog packet will always be sent even if the syslog server does not exist. Possible modes are:</p> <p>Enabled: enable server mode</p> <p>Disabled: disable server mode</p>
Server Address	<p>Indicates the IPv4 host address of syslog server. If the switch provides DNS functions, it also can be a host name.</p>
Syslog Level	<p>Select the severity level for the syslog messages to be logged. The list contains:</p> <p>Error: Log error messages.</p> <p>Warning: Log warning messages.</p> <p>Notice: Log messages that represent significant condition but not errors.</p> <p>Informational: Log informational messages.</p>

Event Selection

SYSLOG and SMTP are two warning methods supported by the system. Check the corresponding box to enable the system event warning method you want. Please note that the checkbox cannot be checked when SYSLOG or SMTP is disabled.

System Warning - Event Selection

System Events	SYSLOG
System Start	<input type="checkbox"/>
Power Status	<input type="checkbox"/>
SNMP Authentication Failure	<input type="checkbox"/>
Redundant Ring Topology Change	<input type="checkbox"/>

Port	SYSLOG	Port	SYSLOG
1	Disabled ▼	2	Disabled ▼
3	Disabled ▼	4	Disabled ▼
5	▼	6	▼
7	▼	8	▼
9	▼	10	▼
11	▼	12	▼

Save Reset

Label	Description
System Cold Start	Sends out alerts when the system is restarted
Power Status	Sends out alerts when power is up or down
SNMP Authentication Failure	Sends out alert when SNMP authentication fails
Redundant-Ring Topology Change	Sends out alerts when Redundant-Ring topology changes
Port Event SYSLOG	<ul style="list-style-type: none"> ■ Disable ■ Link Up ■ Link Down ■ Link Up & Link Down
Apply	Click to activate the configurations
Help	Shows help file

6.10 Monitor and Diag

6.10.1 MAC Table

The MAC address table can be configured on this page. You can set timeouts for entries in the dynamic MAC table and configure the static MAC table here.

MAC Address Table Configuration

Aging Configuration

Disable Automatic Aging

Aging Time seconds

MAC Table Learning

	Port Members																			
	1	2	3	4	5	6	7	8	9	10	11	12	13	14	15	16	17	18	19	20
Auto	<input checked="" type="radio"/>	<input checked="" type="radio"/>	<input checked="" type="radio"/>	<input checked="" type="radio"/>	<input checked="" type="radio"/>	<input checked="" type="radio"/>	<input checked="" type="radio"/>	<input checked="" type="radio"/>	<input checked="" type="radio"/>	<input checked="" type="radio"/>	<input checked="" type="radio"/>	<input checked="" type="radio"/>	<input checked="" type="radio"/>	<input checked="" type="radio"/>	<input checked="" type="radio"/>	<input checked="" type="radio"/>	<input checked="" type="radio"/>	<input checked="" type="radio"/>	<input checked="" type="radio"/>	<input checked="" type="radio"/>
Disable	<input type="radio"/>	<input type="radio"/>	<input type="radio"/>	<input type="radio"/>	<input type="radio"/>	<input type="radio"/>	<input type="radio"/>	<input type="radio"/>	<input type="radio"/>	<input type="radio"/>	<input type="radio"/>	<input type="radio"/>	<input type="radio"/>	<input type="radio"/>	<input type="radio"/>	<input type="radio"/>	<input type="radio"/>	<input type="radio"/>	<input type="radio"/>	<input type="radio"/>
Secure	<input type="radio"/>	<input type="radio"/>	<input type="radio"/>	<input type="radio"/>	<input type="radio"/>	<input type="radio"/>	<input type="radio"/>	<input type="radio"/>	<input type="radio"/>	<input type="radio"/>	<input type="radio"/>	<input type="radio"/>	<input type="radio"/>	<input type="radio"/>	<input type="radio"/>	<input type="radio"/>	<input type="radio"/>	<input type="radio"/>	<input type="radio"/>	<input type="radio"/>

Static MAC Table Configuration

Delete	VLAN ID	MAC Address	Port Members																			
			1	2	3	4	5	6	7	8	9	10	11	12	13	14	15	16	17	18	19	20
Delete	1	00-00-00-00-00-00	<input type="checkbox"/>	<input type="checkbox"/>	<input type="checkbox"/>	<input type="checkbox"/>	<input type="checkbox"/>	<input type="checkbox"/>	<input type="checkbox"/>	<input type="checkbox"/>	<input type="checkbox"/>	<input type="checkbox"/>	<input type="checkbox"/>	<input type="checkbox"/>	<input type="checkbox"/>	<input type="checkbox"/>	<input type="checkbox"/>	<input type="checkbox"/>	<input type="checkbox"/>	<input type="checkbox"/>	<input type="checkbox"/>	<input type="checkbox"/>

Aging Configuration

By default, dynamic entries are removed from the MAC after 300 seconds. This removal is called aging.

You can configure aging time by entering a value in the box below in seconds; for example, **Age Time** seconds.

The allowed range is 10 to 1000000 seconds.

You can disable the automatic aging of dynamic entries by checking **Disable Automatic Aging**.

MAC Table Learning

If the learning mode for a given port is grayed out, it means another module is in control of the mode, and thus the user cannot change the configurations. An example of such a module is MAC-Based authentication under 802.1X.

You can configure the port to dynamically learn the MAC address based upon the following settings:

MAC Table Learning

	Port Members																			
	1	2	3	4	5	6	7	8	9	10	11	12	13	14	15	16	17	18	19	20
Auto	<input checked="" type="radio"/>	<input checked="" type="radio"/>	<input checked="" type="radio"/>	<input checked="" type="radio"/>	<input checked="" type="radio"/>	<input checked="" type="radio"/>	<input checked="" type="radio"/>	<input checked="" type="radio"/>	<input checked="" type="radio"/>	<input checked="" type="radio"/>	<input checked="" type="radio"/>	<input checked="" type="radio"/>	<input checked="" type="radio"/>	<input checked="" type="radio"/>	<input checked="" type="radio"/>	<input checked="" type="radio"/>	<input checked="" type="radio"/>	<input checked="" type="radio"/>	<input checked="" type="radio"/>	<input checked="" type="radio"/>
Disable	<input type="radio"/>	<input type="radio"/>	<input type="radio"/>	<input type="radio"/>	<input type="radio"/>	<input type="radio"/>	<input type="radio"/>	<input type="radio"/>	<input type="radio"/>	<input type="radio"/>	<input type="radio"/>	<input type="radio"/>	<input type="radio"/>	<input type="radio"/>	<input type="radio"/>	<input type="radio"/>	<input type="radio"/>	<input type="radio"/>	<input type="radio"/>	<input type="radio"/>
Secure	<input type="radio"/>	<input type="radio"/>	<input type="radio"/>	<input type="radio"/>	<input type="radio"/>	<input type="radio"/>	<input type="radio"/>	<input type="radio"/>	<input type="radio"/>	<input type="radio"/>	<input type="radio"/>	<input type="radio"/>	<input type="radio"/>	<input type="radio"/>	<input type="radio"/>	<input type="radio"/>	<input type="radio"/>	<input type="radio"/>	<input type="radio"/>	<input type="radio"/>

Label	Description
Auto	Learning is done automatically as soon as a frame with unknown SMAC is received.
Disable	No learning is done.
Secure	Only static MAC entries are learned, all other frames are dropped. Note: make sure the link used for managing the switch is added to the static Mac table before changing to secure learning mode, otherwise the management link will be lost and can only be restored by using another non-secure port or by connecting to the switch via the serial interface.

Static MAC Table Configurations

The static entries in the MAC table are shown in this table. The static MAC table can contain up to 64 entries. The entries are for the whole stack, not for individual switches. The MAC table is sorted first by VLAN ID and then by MAC address.

Static MAC Table Configuration																						
Delete	VLAN ID	MAC Address	Port Members																			
			1	2	3	4	5	6	7	8	9	10	11	12	13	14	15	16	17	18	19	20
Delete	1	00-00-00-00-00-00	<input type="checkbox"/>	<input type="checkbox"/>	<input type="checkbox"/>	<input type="checkbox"/>	<input type="checkbox"/>	<input type="checkbox"/>	<input type="checkbox"/>	<input type="checkbox"/>	<input type="checkbox"/>	<input type="checkbox"/>	<input type="checkbox"/>	<input type="checkbox"/>	<input type="checkbox"/>	<input type="checkbox"/>	<input type="checkbox"/>	<input type="checkbox"/>	<input type="checkbox"/>	<input type="checkbox"/>	<input type="checkbox"/>	
Add New Static Entry																						

Label	Description
Delete	Check to delete an entry. It will be deleted during the next save.
VLAN ID	The VLAN ID for the entry
MAC Address	The MAC address for the entry
Port Members	Checkmarks indicate which ports are members of the entry. Check or uncheck to modify the entry.
Adding New Static Entry	Click to add a new entry to the static MAC table. You can specify the VLAN ID, MAC address, and port members for the new entry. Click Save to save the changes.

MAC Table

Each page shows up to 999 entries from the MAC table, with a default value of 20, selected by the **Entries Per Page** input field. When first visited, the web page will show the first 20 entries from the beginning of the MAC Table. The first displayed will be the one with the lowest VLAN ID and the lowest MAC address found in the MAC Table.

Each page shows up to 999 entries from the MAC table, with a default value of 20, selected by

6.10.2 Port Statistics

Traffic Overview

This page provides an overview of general traffic statistics for all switch ports.

Port Statistics Overview

Auto-refresh Refresh Clear

Port	Description	Packets		Bytes		Errors		Drops		Filtered Received
		Received	Transmitted	Received	Transmitted	Received	Transmitted	Received	Transmitted	
1		0	0	0	0	0	0	0	0	0
2		42716	18891	5721301	3208070	0	0	0	0	1967
3		0	0	0	0	0	0	0	0	0
4		0	0	0	0	0	0	0	0	0
5		0	0	0	0	0	0	0	0	0
6		0	0	0	0	0	0	0	0	0
7		0	0	0	0	0	0	0	0	0
8		0	0	0	0	0	0	0	0	0
9		0	0	0	0	0	0	0	0	0
10		0	0	0	0	0	0	0	0	0
11		0	0	0	0	0	0	0	0	0
12		0	0	0	0	0	0	0	0	0

Label	Description
Port	The switch port number to which the following settings will be applied.
Packets	The number of received and transmitted packets per port
Bytes	The number of received and transmitted bytes per port
Errors	The number of frames received in error and the number of incomplete transmissions per port
Drops	The number of frames discarded due to ingress or egress congestion
Filtered	The number of received frames filtered by the forwarding process
Auto-refresh	Check to enable an automatic refresh of the page at regular intervals.
Refresh	Updates the counter entries, starting from the current entry ID.
Clear	Flushes all counters entries

Detailed Statistics

This page provides detailed traffic statistics for a specific switch port. Use the port drop-down list to decide the details of which switch port to be displayed.

The displayed counters include the total number for receive and transmit, the size for receive and transmit, and the errors for receive and transmit.

Detailed Statistics – Total Receive & Transmit

Detailed Port Statistics Port 1			
Port 1 ▾ Auto-refresh <input type="checkbox"/> Refresh Clear			
Receive Total		Transmit Total	
Rx Packets	0	Tx Packets	0
Rx Octets	0	Tx Octets	0
Rx Unicast	0	Tx Unicast	0
Rx Multicast	0	Tx Multicast	0
Rx Broadcast	0	Tx Broadcast	0
Rx Pause	0	Tx Pause	0
Receive Size Counters		Transmit Size Counters	
Rx 64 Bytes	0	Tx 64 Bytes	0
Rx 65-127 Bytes	0	Tx 65-127 Bytes	0
Rx 128-255 Bytes	0	Tx 128-255 Bytes	0
Rx 256-511 Bytes	0	Tx 256-511 Bytes	0
Rx 512-1023 Bytes	0	Tx 512-1023 Bytes	0
Rx 1024-1526 Bytes	0	Tx 1024-1526 Bytes	0
Rx 1527- Bytes	0	Tx 1527- Bytes	0
Receive Queue Counters		Transmit Queue Counters	
Rx Q0	0	Tx Q0	0
Rx Q1	0	Tx Q1	0
Rx Q2	0	Tx Q2	0
Rx Q3	0	Tx Q3	0
Rx Q4	0	Tx Q4	0
Rx Q5	0	Tx Q5	0
Rx Q6	0	Tx Q6	0
Rx Q7	0	Tx Q7	0

Label	Description
Rx and Tx Packets	The number of received and transmitted (good and bad) packets
Rx and Tx Octets	The number of received and transmitted (good and bad) bytes, including FCS, except framing bits
Rx and Tx Unicast	The number of received and transmitted (good and bad) unicast packets
Rx and Tx Multicast	The number of received and transmitted (good and bad) multicast packets
Rx and Tx Broadcast	The number of received and transmitted (good and bad) broadcast packets
Rx and Tx Pause	The number of MAC Control frames received or transmitted on this port that have an opcode indicating a PAUSE operation
Rx Drops	The number of frames dropped due to insufficient receive buffer or egress congestion
Rx CRC/Alignment	The number of frames received with CRC or alignment errors
Rx Undersize	The number of short ¹ frames received with a valid CRC
Rx Oversize	The number of long ² frames received with a valid CRC
Rx Fragments	The number of short ¹ frames received with an invalid CRC
Rx Jabber	The number of long ² frames received with an invalid CRC
Rx Filtered	The number of received frames filtered by the forwarding process
Tx Drops	The number of frames dropped due to output buffer congestion
Tx Late / Exc.Coll.	The number of frames dropped due to excessive or late collisions

1. Short frames are frames smaller than 64 bytes.
2. Long frames are frames longer than the maximum frame length configured for this port.

6.10.3 Port Monitoring

You can configure port mirroring on this page. To solve network problems, selected traffic can be copied, or mirrored, to a mirror port where a frame analyzer can be attached to analyze the frame flow. The traffic to be copied to the mirror port is selected as follows:

All frames received on a given port (also known as ingress or source mirroring).

All frames transmitted on a given port (also known as egress or destination mirroring).

Port to mirror is also known as the mirror port. Frames from ports that have either source (rx) or destination (tx) mirroring enabled are mirrored to this port. Disabled option disables mirroring.

Mirroring & Remote Mirroring Configuration

Mode	Disabled ▼
Type	Mirror ▼
VLAN ID	200
Reflector Port	Port 1 ▼

Source VLAN(s) Configuration

Source VLANs

Port Configuration

Port	Source	Intermediate	Destination
1	Disabled ▼	<input type="checkbox"/>	<input type="checkbox"/>
2	Disabled ▼	<input type="checkbox"/>	<input type="checkbox"/>
3	Disabled ▼	<input type="checkbox"/>	<input type="checkbox"/>
4	Disabled ▼	<input type="checkbox"/>	<input type="checkbox"/>
5	Disabled ▼	<input type="checkbox"/>	<input type="checkbox"/>

Label	Description
Mode	Enable or disable this function.
Type	<p>Mirror: the switch is running on mirror mode. The source port(s) and destination port are located on this switch.</p> <p>Source: the switch is a source node for monitor flow. The source port(s) and intermediate port(s) are located on this switch.</p> <p>Intermediate: the switch is a forwarding node for monitor flow and the switch is an option node. The object is to forward traffic from source</p>

	<p>switch to destination switch. The intermediate ports are located on this switch.</p> <p>Destination: the switch is an end node for monitor flow. The destination port(s) and intermediate port(s) are located on this switch.</p>
VLAN ID	The VLAN ID points out where the monitor packet will copy to. The default VLAN ID is 200.
Reflector Port	Select a reflector port. This port carries all the mirrored traffic at source switch.
Source VLANs	The switch can support VLAN-based mirroring. If you want to monitor some VLANs on the switch, you can set the selected VLANs on this field.
Port	The logical port for the settings contained in the same row. The CPU also can be selected.
Source	<p>Selects mirror mode.</p> <p>Disabled: Neither frames transmitted nor frames received are mirrored.</p> <p>Both: Frames received and frames transmitted are mirrored on the Intermediate/Destination port.</p> <p>Rx only: Frames received on this port are mirrored on the Intermediate/Destination port. Frames transmitted are not mirrored.</p> <p>Tx only: Frames transmitted on this port are mirrored on the Intermediate/Destination port. Frames received are not mirrored.</p>
Intermediate	Select intermediate port. This checkbox is designed for Remote Mirroring. The intermediate port is a switched port to connect to other switch. All packets that are going through intermediate port will be tagged when the mirror function is enabled.
Destination	Select destination port. This checkbox is designed for mirror or Remote Mirroring. The destination port is a switched port that you receive a copy of traffic from the source port.

6.10.4 System Log Information

This page provides switch system log information.

System Log Information

Auto-refresh Refresh Clear |<< << >> >>|

Level	All ▼
Clear Level	All ▼

The total number of entries is 3 for the given level.

Start from ID with entries per page.

ID	Level	Time	Message
1	Notice	1970-01-01T00:00:10+00:00	LINK-UPDOWN: Interface Vlan 1, changed state to down.
2	Notice	1970-01-01T00:00:16+00:00	LINK-UPDOWN: Interface Vlan 1, changed state to up.
3	Notice	1970-01-01T00:40:49+00:00	LINK-UPDOWN: Interface Vlan 1, changed state to up.

Label	Description
ID	The ID (>= 1) of the system log entry
Level	<p>The level of the system log entry. The following level types are supported:</p> <p>Notice: Log messages that represent significant condition but not errors.</p> <p>Informational: Log informational messages.</p> <p>Warning: Log warning messages.</p> <p>Error: Log error messages.</p> <p>All: Log all messages.</p>
Time	The time of the system log entry
Message	The MAC address of the switch
Auto-refresh	Check this box to enable an automatic refresh of the page at regular intervals.
Refresh	Updates system log entries, starting from the current entry ID
Clear	Flushes all system log entries
<<	Updates system log entries, starting from the first available entry ID
<<	Updates system log entries, ending at the last entry currently displayed
>>	Updates system log entries, starting from the last entry currently displayed.
>>	Updates system log entries, ending at the last available entry ID.

6.10.5 Cable Diagnostics

This page allows you to perform VeriPHY cable diagnostics.

VeriPHY Cable Diagnostics

Port All ▼

Start

Cable Status								
Port	Pair A	Length A	Pair B	Length B	Pair C	Length C	Pair D	Length D
1	--	--	--	--	--	--	--	--
2	--	--	--	--	--	--	--	--
3	--	--	--	--	--	--	--	--
4	--	--	--	--	--	--	--	--
5	--	--	--	--	--	--	--	--
6	--	--	--	--	--	--	--	--
7	--	--	--	--	--	--	--	--
8	--	--	--	--	--	--	--	--
9	--	--	--	--	--	--	--	--
10	--	--	--	--	--	--	--	--
11	--	--	--	--	--	--	--	--
12	--	--	--	--	--	--	--	--
13	--	--	--	--	--	--	--	--
14	--	--	--	--	--	--	--	--
15	--	--	--	--	--	--	--	--
16	--	--	--	--	--	--	--	--

Press **Start** to run the diagnostics. This will take approximately 5 seconds. If all ports are selected, this can take approximately 15 seconds. When completed, the page refreshes automatically, and you can view the cable diagnostics results in the cable status table. Note that VeriPHY diagnostics is only accurate for cables 7 - 140 meters long.

10 and 100 Mbps ports will be disconnected while running VeriPHY diagnostics. Therefore, running VeriPHY on a 10 or 100 Mbps management port will cause the switch to stop responding until VeriPHY is complete.

Label	Description
Port	The port for which VeriPHY Cable Diagnostics is requested
Cable Status	Port: port number Pair: the status of the cable pair Length: the length (in meters) of the cable pair

6.10.6 SFP Monitor

SFP modules with DDM (Digital Diagnostic Monitoring) function can measure the temperature of the apparatus, helping you monitor the status of connection and detect errors immediately. You can manage and set up event alarms through DDM Web interface.

SFP Monitor

Auto-refresh Refresh

Port No.	Temperature (°C)	Vcc (V)	TX Bias (mA)	TX Power (mW)	(dBm)	RX Power (mW)	(dBm)
17	N/A	N/A	N/A	N/A	N/A	N/A	N/A
18	N/A	N/A	N/A	N/A	N/A	N/A	N/A
19	N/A	N/A	N/A	N/A	N/A	N/A	N/A
20	N/A	N/A	N/A	N/A	N/A	N/A	N/A

Warning Temperature :
 °C(0~100)

Event Alarm :
 Syslog

6.10.7 SFP Type

This page shows the details of the SFP port. For each port, the summary displays the SFP type, the vendor name and serial number.

SFP Type

Auto-refresh Refresh

Port	Vendor	PID	Version	Type
17				
18				
19				
20				

6.10.8 Ping

This page allows you to issue ICMP PING packets to troubleshoot IP connectivity issues.

ICMP Ping

IP Address	0.0.0.0
Ping Length	56
Ping Count	5
Ping Interval	1

After you press **Start**, five ICMP packets will be transmitted, and the sequence number and roundtrip time will be displayed upon reception of a reply. The page refreshes automatically until responses to all packets are received, or until a timeout occurs.

PING6 server ::10.10.132.20

64 bytes from ::10.10.132.20: icmp_seq=0, time=0ms

64 bytes from ::10.10.132.20: icmp_seq=1, time=0ms

64 bytes from ::10.10.132.20: icmp_seq=2, time=0ms

64 bytes from ::10.10.132.20: icmp_seq=3, time=0ms

64 bytes from ::10.10.132.20: icmp_seq=4, time=0ms

Sent 5 packets, received 5 OK, 0 bad

You can configure the following properties of the issued ICMP packets:

Label	Description
IP Address	The destination IP Address
Ping Size	The payload size of the ICMP packet. Values range from 8 to 1400 bytes.

IPv6 Ping

ICMPv6 Ping

IP Address	0:0:0:0:0:0:0:0
Ping Length	56
Ping Count	5
Ping Interval	1
Egress Interface	

PING6 server ::192.168.10.1

sendto

sendto

sendto

sendto

sendto

Sent 5 packets, received 0 OK, 0 bad

6.11 Configuration

This setting allows you to activate or delete configuration files. Simply select the files to be activated or deleted and press the button.

6.11.1 Activate

Activate Configuration

Select configuration file to activate. The previous configuration will be completely replaced, potentially leading to loss of management connectivity.

Please note: The activated configuration file will not be saved to startup-config automatically.

File Name
<input type="radio"/> default-config
<input type="radio"/> startup-config

Activate Configuration

6.11.2 Delete

Delete Configuration File

Select configuration file to delete.

File Name
<input type="radio"/> startup-config

Delete Configuration File

6.12 Save

You can save current configurations as a startup configuration file.

Save Running Configuration to startup-config

Please note: The generation of the configuration file may be time consuming, depending on the amount of non-default configuration.

Save Configuration

6.13 Troubleshooting

6.13.1 Factory Defaults

You can reset the configuration of the stack switch on this page. Only the IP configuration is retained.

Factory Defaults

**Are you sure you want to reset the configuration to
Factory Defaults?**

Label	Description
Yes	Click to reset the configuration to factory defaults
No	Click to return to the Port State page without resetting

6.13.2 System Reboot

You can reset the stack switch on this page. After reset, the system will boot normally as if you have powered on the devices.

Warm Reset

Are you sure you want to perform a Warm Restart?

Label	Description
Yes	Click to reboot device
No	Click to return to the Port State page without rebooting

Technical Specifications

ORing Switch Model	IGS-9822DGP+
Physical Ports	
10/100/1000Base-T(X) with Ports in RJ45 Auto MDI/MDIX	8
100/1G/2.5GBase-X with SFP port	2
1G/10GBase-X with SFP port	2
Technology	
Ethernet Standards	IEEE 802.3 for 10Base-T IEEE 802.3u for 100Base-TX and 100Base-FX IEEE 802.3ab for 1000Base-T IEEE 802.3z for 1000Base-X IEEE 802.3x for Flow control IEEE 802.3ad for LACP (Link Aggregation Control Protocol) IEEE 802.1p for COS (Class of Service) IEEE 802.1Q for VLAN Tagging IEEE 802.1D for STP (Spanning Tree Protocol) IEEE 802.1w for RSTP (Rapid Spanning Tree Protocol) IEEE 802.1s for MSTP (Multiple Spanning Tree Protocol) IEEE 802.1x for Authentication IEEE 802.1AB for LLDP (Link Layer Discovery Protocol)
MAC Table	32k
Priority Queues	8
Processing	Store-and-Forward
Packet Buffer	32Mbits
Switch Properties	Switching latency: 7 us Switching bandwidth: 66Gbps Throughput (packet per second) : 49.1Mpps@64Bytes packet Max. Number of Available VLANs: 4096 VLAN ID Range : VID 0 to 4095 IGMP multicast groups: 64 for each VLAN Port rate limiting: User Define
Jumbo frame	Up to 10K Bytes
Security Features	Device Binding security feature Enable/disable ports, MAC based port security Port based network access control (802.1x) VLAN (802.1Q) to segregate and secure network traffic RADIUS/TACACS+ centralized password management SNMPv3 encrypted authentication and access security HTTPS / SSH / SSL enhance network security DOS/DDOS auto prevention
Software Features	Redundant Ring (O-Ring) with recovery time less than 30ms Quality of Service (802.1p) for real-time traffic VLAN (802.1Q) with VLAN tagging IGMP Snooping IP-based bandwidth management Application-based QoS management Port configuration, status, statistics, monitoring, security DHCP Server/Client/Relay SMTP Client Modbus TCP NTP server/client UPnP
QoS	TOS/Diffserv supported CoS Application based QoS IP based bandwidth management
Network Redundancy	O-Ring O-Chain

	MRP*NOTE STP/RSTP/MSTP (IEEE 802.1 d/w/s)
RS-232 Serial Console Port	RS-232 in RJ45 connector with console cable. 115200bps, 8, N, 1
LED indicators	
Power Indicator (PWR)	Green : Power LED x 3
Ring Master Indicator (R.M.)	Green : Indicates that the system is operating in O-Ring Master mode
O-Ring Indicator (Ring)	Green : Indicates that the system operating in O-Ring mode Green Blinking : Indicates that the Ring is broken.
Fault Indicator (Fault)	Amber : Indicate unexpected event occurred
10/100/1000Base-T(X) RJ45 Port Indicator	Green for port Link/Act(Upper) Dual color LED for speed: Green for 1000Mbps, Amber for 100Mbps, off-light for 10Mbps(Lower)
1G/2.5GBase-X SFP Port Indicator	Green LED for Link/Act
1G/10Gbase-X SFP Port Indicator	Green LED for Link/Act
Fault contact	
Relay	Relay output to carry capacity of 1A at 24VDC
Reset Function	
Reset Button	< 5 sec: System reboot, > 5 sec: Factory default
Power	
Redundant Input power	Dual DC inputs 12~48VDC on 6-pin terminal block
Power consumption (Typ.)	19 Watts
Overload current protection	Present
Reverse Polarity Protection	Present
Physical Characteristic	
Enclosure	IP-30
Dimension (W x D x H)	74.3 (W) x 125 (D) x 153.6 (H) mm (2.93 x 4.92 x 6.05 inches)
Weight (g)	1078 g
Environmental	
Storage Temperature	-40 to 85°C (-40 to 185°F)
Operating Temperature	-20 to 60°C (-14 to 140°F) at 2.5G/10G SFP -40 to 75°C (-40 to 167°F) at full Gigabit
Operating Humidity	5% to 95% Non-condensing
Regulatory approvals	
EMC	CE EMC (EN 55024, EN 55032), FCC Part 15 B
EMI	EN 55032, CISPR32, EN 61000-3-2, EN 61000-3-3, FCC Part 15 B class A
EMS	EN 55024 (IEC/EN 61000-4-2 (ESD), IEC/EN 61000-4-3 (RS), IEC/EN 61000-4-4 (EFT), IEC/EN 61000-4-5 (Surge), IEC/EN 61000-4-6 (CS), IEC/EN 61000-4-8(PFMF), IEC/EN 61000-4-11 (DIP))
Shock	IEC60068-2-27
Free Fall	IEC60068-2-31
Vibration	IEC60068-2-6
Safety	EN60950-1
MTBF	585191 hrs
Warranty	5 years