

Quick Installation Guide

IES-180-L





Industrial Unmanaged Switch

Introduction

IES-180-L is an unmanaged Ethernet switch with eight 10/100Base-T(X) ports in a compact form factor. The easy-to-install switch comes with rigid IP-30 housing and can operate in harsh environments. The wide operating temperature range from -20°C to 60°C ensures the switch can operate reliably in extreme weather conditions.

Package Contents





The device is shipped with the following items. If any of these items is missing or damaged, please contact your customer service representative for assistance.

Contents	Pictures	Number
IES-180-L		X 1
DIN-rail Kit		X 1
Wall-mount Kit		X 2
QIG		X 1

Preparation

Before you begin installing the switch, make sure you have all of the package contents available.

Safety & Warnings

-  **Elevated Operating Ambient:** If installed in a closed cabinet, the operating ambient temperature of the rack environment may be greater than room ambient. Therefore, consideration should be given to installing the equipment in an environment compatible with the maximum ambient temperature (T_{ma}) specified by the manufacturer.
-  **Reduced Air Flow:** Installation of the equipment should be such that the amount of air flow required for safe operation of the equipment is not compromised.
-  **Mechanical Loading:** Mounting of the equipment in the din-rail should be such that a hazardous condition is not achieved due to uneven mechanical loading.
-  **Circuit Overloading:** Consideration should be given to the connection of the equipment to the supply circuit and the effect that overloading of the circuits might have on overcurrent protection and supply wiring. Appropriate consideration of equipment nameplate ratings should be used when addressing this concern.

Dimension (Unit: mm)

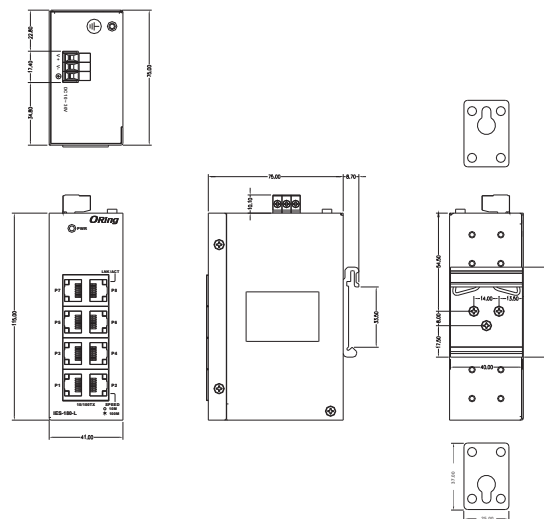

Panel Layouts

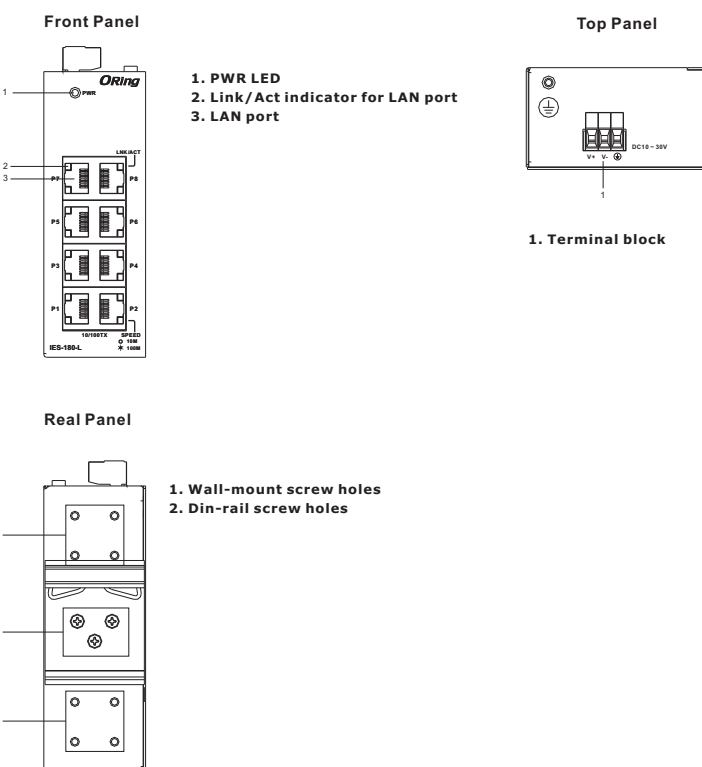

Installation

DIN-rail Installation

- Step 1:** Slant the switch and screw the Din-rail kit onto the back of the switch, right in the middle of the back panel.
- Step 2:** Slide the switch onto a DIN-rail from the Din-rail kit and make sure the switch clicks into the rail firmly.

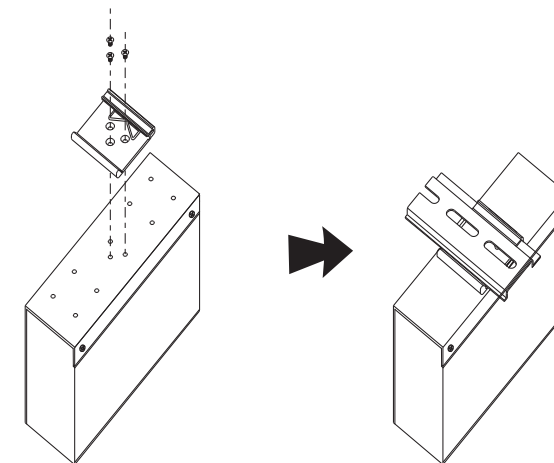

Wall-mounting

- Step 1:** Screw the two pieces of wall-mount kits onto both sides of the switch. A total of eight screws are required, as shown below.
- Step 2:** Use the switch, with wall mount plates attached, as a guide to mark the correct locations of wall-mount screws.
- Step 3:** Insert screw through the large parts of the keyhole-shaped apertures, and then slide the switch downwards. Tighten the four screws for added stability.

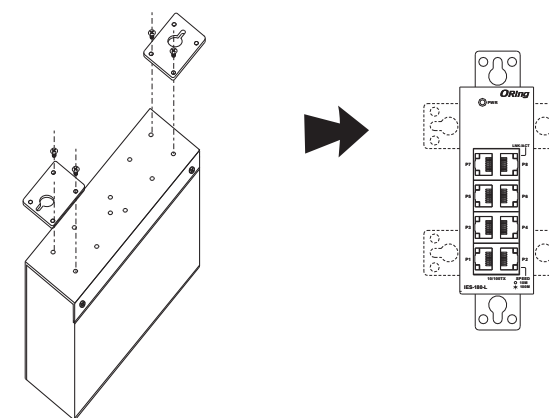

Network Connection

The device has standard Ethernet ports. According to the link type, the switch uses CAT 3, 4, 5, 5e UTP cables to connect to any other network devices (PCs, servers, switches, routers, or hubs). Please refer to the following table for cable specifications.

Cable Types and Specifications:

Cable	Type	Max. Length	Connector
10BASE-T	Cat. 3, 4, 5 100-ohm	UTP 100 m (328 ft)	RJ-45
100BASE-TX	Cat. 5 100-ohm UTP	UTP 100 m (328 ft)	RJ-45

For pin assignments for the cables, please refer to the following table.

10/100Base-T(X) RJ-45	
Pin Number	Assignment
1	TD+
2	TD-
3	RD+
4	Not used
5	Not used
6	RD-
7	Not used
8	Not used

Note: "+" and "-" signs represent the polarity of the wires that make up each wire pair.

Wiring

Power inputs

The switch provides a 10~30 VDC voltage power input on a 3-pin terminal block. Follow the steps to connect the power.

STEP 1: Insert the negative/positive wires into the V-/V+ terminals, respectively.



STEP 2: To keep the DC wires from pulling loose, use a small flat-blade screwdriver to tighten the wire-clamp screws on the front of the terminal block connector.

Configurations

After installing the switch and connecting cables, start the switch by turning on power. The green power and LEDs should turn on.

LED indication table

LED	Color	Status	Description
PWR	Green	On	DC power module activated
LNK/ACT	Green	On	Port is linked
		Blinking	Transmitting data
	Amber	On	Port is running at 100Mbps
		Off	Port is running at 10Mbps

Specifications

ORing Switch Model	IES-180-L
Physical Ports	
10/100Base-T(X) Ports in RJ45 Auto MDI/MDIX	8
Technology	
Ethernet Standards	IEEE 802.3 for 10Base-T IEEE 802.3u for 100Base-TX IEEE 802.3x for Flow control
MAC Table	2048 MAC addresses
Packet Buffer	448Kbits
Processing	Store-and-Forward
Power	
Input power	10~30 VDC voltage power input on 3-pin terminal block
Power consumption(Typ.)	1.65 Watts
Overload current protection	Present
Reverse polarity protection	Present
Physical Characteristic	
Enclosure	IP-30
Dimension (W x D x H)	41 (W) x 75 (D) x 115 (H)mm (1.61 x 2.95 x 4.53 inch)
Weight (g)	307 g
Environmental	
Storage Temperature	-40 to 85°C (-40 to 185°F)
Operating Temperature	-20 to 60°C (-4 to 140°F)
Operating Humidity	5% to 95% Non-condensing
Regulatory Approvals	
EMI	FCC Part 15, CISPR (EN55022) class A
EMS	EN61000-4-2 (ESD), EN61000-4-3 (RS), EN61000-4-4 (EFT), EN61000-4-5 (Surge), EN61000-4-6 (CS), EN61000-4-8, EN61000-4-11
Shock	IEC60068-2-27
Free Fall	IEC60068-2-32
Vibration	IEC60068-2-6
Safety	EN60950-1
Warranty	5 years

Copyright© 2015 ORing
All rights reserved.



ORing Industrial Networking Corp.
TEL: +886-2-2218-1066 Website: www.oring-networking.com
FAX: +886-2-2218-1014 E-mail: support@oring-networking.com