

**RS-232/422/485/DIO
to Ethernet Data Gateway
Installation Guide**

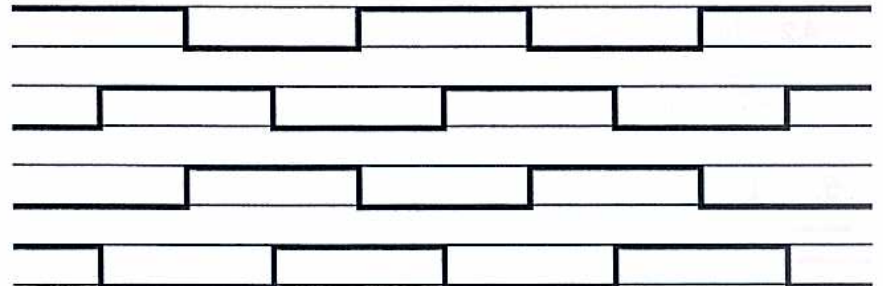

Contents

1. Introduction.....	1
1.1 Features.....	1
1.2 Product Specifications.....	1
2. Package Check List	4
3. Panel Layout	5
3.1 Connector Layout	5
3.2 Front Panel Layout.....	6
3.2.1 RS-232 Pin Assignments and Cable Wiring.....	6
3.2.2 Digital I/O Control Pins (5V TTL Level).....	7
3.2.3 RS-422/485 Pin Assignments	7
3.2.4 DIP Switch Settings.....	7
3.3 Rear Panel Layout	8
3.3.1 Input Power Connectors	9
3.3.2 LED Indicators.....	9
4. Configuring the Data Gateway.....	10
4.1 Etm Manager Program	10
4.2 Web Browser Console Configuration.....	11
4.2.1 Entering the web Browser Console	11
4.2.2 Updating Configuration	13
5. Diagnosing the Data Gateway	17

5.1 Entering Setup.....	17
5.2 Digital I/O.....	19

1. Introduction

Thank you for purchasing this RS-232/422/485/DIO to Ethernet Data Gateway. It allows you to control RS-232, RS-422, RS-485 and Digital Input/Output devices over a TCP/IP-based Ethernet. It provides TCP Server Mode, TCP Client Mode and UDP Modes that compatible with the standard network API (Winsock or BSD Sockets). It provides a web browser console to change its settings by Internet Browser easily.

1.1 Features

- ✓ Provides one RS232/422/485 Port over LAN
- ✓ Provides 7 Digital I/O Lines over LAN
- ✓ Allows to Reset the Hardware from External
- ✓ Supports 4-wire RS-422/485 and 2-wire RS-485 applications
- ✓ 300bps to 115.2Kbps Serial Port Baud Rate
- ✓ Built-in 15KV ESD Protection for ALL Signals
- ✓ Provides TCP Server, TCP Client, and UDP Modes
- ✓ Provides one 10/100Mbps, RJ45 LAN Port
- ✓ Provides +12V DC from DC Jack or Terminal Blocks

1.2 Product Specifications

Type	Specifications
LAN	10/100Mbps Ethernet
Connector	RJ45
Speed	10/100Mbps

RS-232/422/485	
No. of Ports	1 (RS-232 and RS-422/485 are shared port, only one of them can be used simultaneously)
Interface	4-wire RS-422: TxD+/-, RxD+/- 4-wire RS-495: TxD+/-, RxD+/- 2-wire RS-485: Data+/- RS-232 signals: TXD,RXD,RTS,CTS,DTR,DSR,DCD,GND
Connector	Terminal Block (RS-422/485) DB9 male (RS-232)
Serial and LAN and Digital I/O Line Protection	15KV
Watch Dog Timer	Built-in
Parity	None, Odd, Even
Data bits	7, 8
Stop bit	1, 2
Speed	300 to 115.2Kbps
Power Requirements	
Power Input	12V DC (via DC Jack), or 12V DC (via Terminal Block)

Power Consumption	110mA @ 12V DC
Mechanical Specifications	
Material	Metal
Gross Weight	380 ± 5g (0.84 lb)
Environmental	
Operating Temperature	0 to 55°C (32 to 131°F)
Storage Temperature	-20 to 85°C (-4 to 185°F)
Operating Humidity	5 to 95% RH

2. Package Check List

Before installing the product, please make sure the following accessories are well packed in the box :

- RS-232/422/485/DIO to Ethernet Data Gateway x 1
- Optional 12V DC, 1.5A AC Adapter x 1
- Installation Guide x 1

(Mark the check box to help you check it)

3. Panel Layout

3.1 Connector Layout

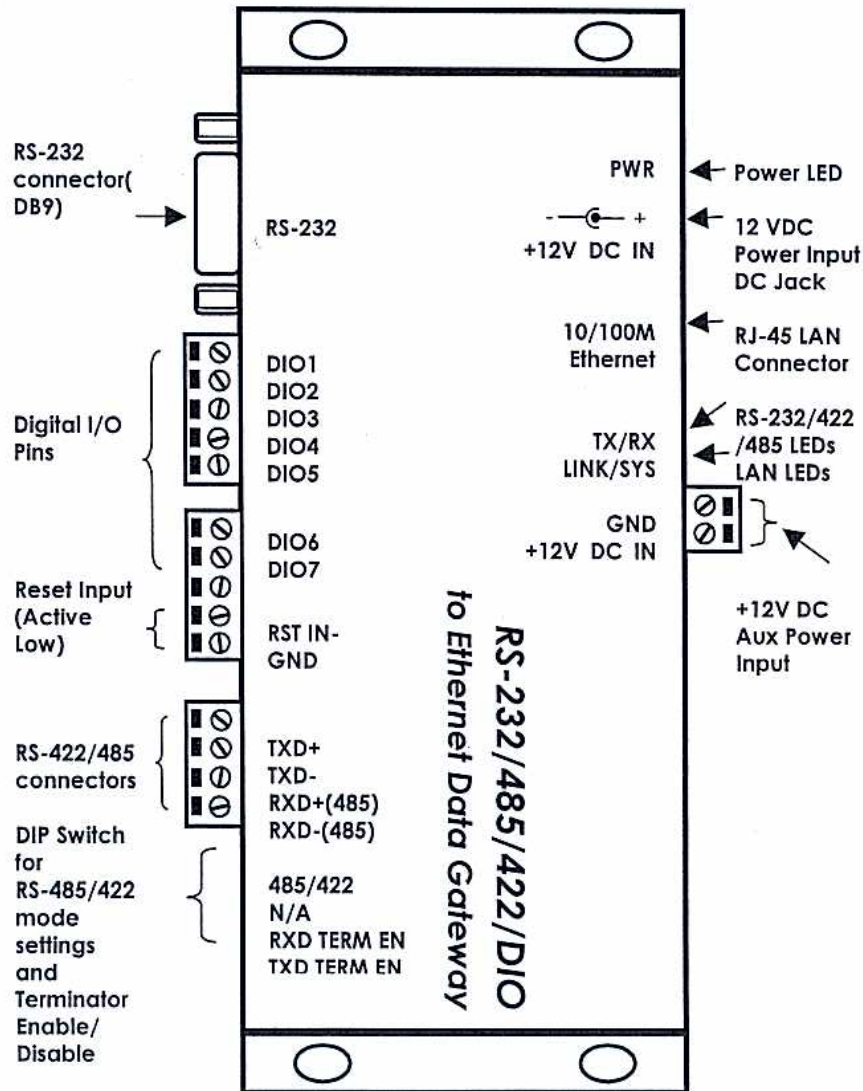

3.2 Front Panel Layout

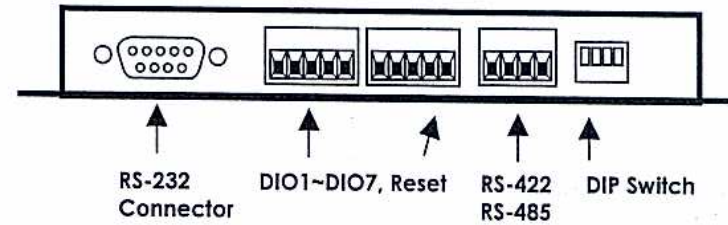

3.2.1 RS-232 Pin Assignments and Cable Wiring

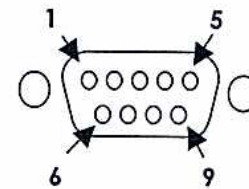

9 Pins	Signal
1	DCD
2	RXD
3	TXD
4	DTR
5	GND
6	DSR
7	RTS
8	CTS
9	NC

DB9(Male) to DB9(Male) Wiring

DB9 (Gateway)	DB9 (Serial Device)
1 DCD	1 DCD
2 RXD	2 RXD
3 TXD	3 TXD
4 DTR	4 DTR
5 GND	5 GND
6 DSR	6 DSR
7 RTS	7 RTS
8 CTS	8 CTS

3.2.2 Digital I/O Control Pins (5V TTL Level)

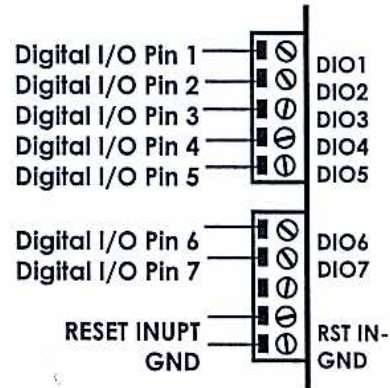

3.2.3 RS-422/485 Pin Assignments

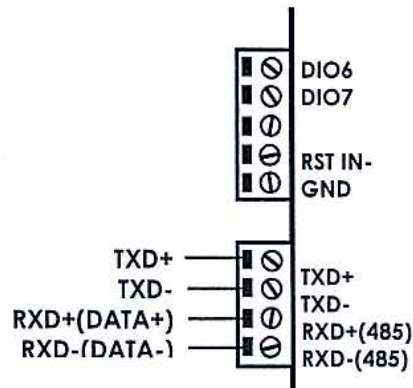

3.2.4 DIP Switch Settings

This DIP switch on the front panel is used to set RS-485 or RS-422 modes, enable and disable the termination resistors on the TxD+/TxD- and RxD+/RxD- wires.

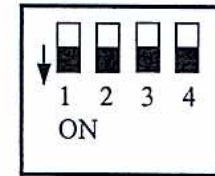

DIP Switch No.	DIP Switch Settings	Mode and Termination Resistor Setting
1	On (default)	2-wire RS-485 mode
	Off	4-wire RS-422/485
2	Not Used (default is On)	Not Used
3	On (default)	RxD Termination Resistor Enabled
	Off	RxD Termination Resistor Disabled
4	On (default)	TxD Termination Resistor Enabled
	Off	TxD Termination Disabled

3.3 Rear Panel Layout

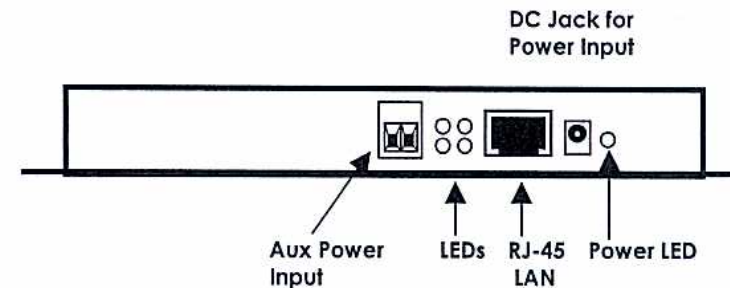

3.3.1 Input Power Connectors

There are 2 connectors (DC jack and Terminator Blocks) for the input power. Connect a 12V DC to either of them. Please do NOT connect power to both connectors.

3.3.2 LED Indicators

There are 4 green LEDs on the rear panel as described in the following table:

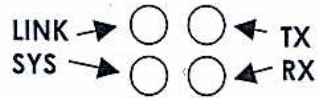

LED Name	LED Function
LINK	Steady On: Ethernet connection is OK Off: Ethernet disconnected, or has a short
SYS	Blinking when Ethernet is transferring data
TX	Blinking when RS-232/422/485 is sending data out
RX	Blinking when RS-232/422/485 is receiving data

4. Configuring the Data Gateway

The configuration of the Data Gateway can be done by running the Etm.exe program or by a web browser by the Data Gateway's web console. If you don't know the IP address of the Data Gateway, the Etm.exe program (see next section) will find and allows you the configure them.

4.1 Etm Manager Program

Etm.exe is a device manager program which runs under the Windows 32 bit environment. Using UDP broadcast packets, Etm.exe allows you to inquire and modify the gateway's basic parameters. Upon executing Etm.exe, the following screen (example) will appear if a gateway is found.

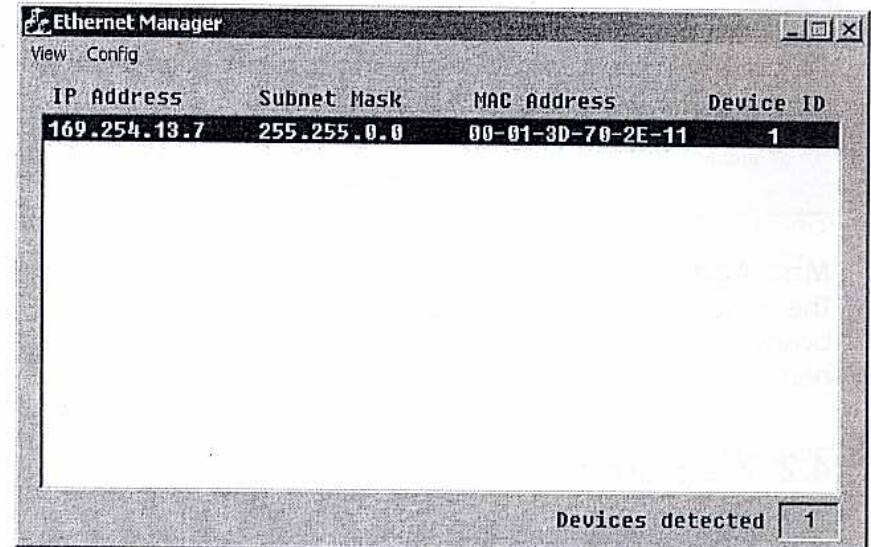

The screen shows number of devices detected, as well as their IP Address, Sub Mask, MAC Address and Device ID. If you select the "View" / "Refresh" function or press <F5> key, the system will re-detect the devices and update the screen accordingly.

Because Etm.exe uses UDP broadcast Packets, it has the following characteristics :

It's not subject to the subnet restriction – the program is usable even if the gateway's IP and PC's IP are not on the same subnet.

Since broadcast packets cannot pass through the router, only the devices on the same network section can be detected.

Due to the fact that Etm.exe uses UDP broadcast, for security reasons the Config function is available when only one device is detected. In this case, the following parameters can be modified under the Config function.

IP Address / Subnet Mask

Enter the new IP Address / Subnet Mask value and click "OK". Or click "Cancel" to abort the operation

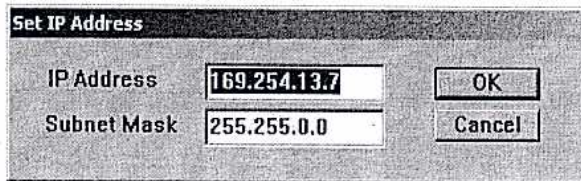

A dialog box titled "Set IP Address" with two input fields and two buttons. The "IP Address" field contains "169.254.13.7" and the "Subnet Mask" field contains "255.255.0.0". The "OK" button is on the right, and the "Cancel" button is on the bottom right.

Mac Address

The Mac Address is automatically generated by the system based on system time. It does not need to be changed under normal operation.

4.2 Web Browser Console Configuration

4.2.1 Entering the web Browser Console

The Data Gateway supports the HTTP communication protocol. All device configurations can be easily set by the web browser. Just type in gateway's IP address or using Etm.exe and select "Config/Device Setting" function, then the following screen will

be displayed.



The following basic information is shown on the screen:

- **System time elapsed** : The elapsed time since the system was turned on. In the screen shown above, the elapsed time is 0 hour 7 minutes and 5 seconds. This information can be used to determine if the device has been operating normally without being reset.
- **Firmware release date** : This is used to identify the firmware version of the Ethernet Data Gateway device.
- **Ethernet address** : The Ethernet address has 6 hex-decimal bytes.

Now, type in the password and click the "Login" button to enter the configuration screen. Note that initially the password is not required, just click the "Login" button.



WARNING! If the correct password is not entered correctly

in three tries, you have to wait at least 20minutes to try again.

The following is an example of the configuration screen.

Controller Setup	
IP address	169.254.13.7
Subnet mask	255.255.0.0
Gateway address	0.0.0.0
DHCP client	Disable
Socket port of HTTP setup	80
Socket port of serial I/O	100 TCP Server
Socket port of digital I/O	101 TCP Server
Destination IP address / socket port (TCP client and UDP)	0.0.0.0 0
Serial I/O settings (baud rate, parity, data bits, stop bits)	57600 N 8 1
Interface of serial I/O	RS 232
Packet mode of serial input	Disable
Packet mode inter-packet timeout	10 ms
Device ID	1
Report device ID when connected	Disable
Setup password	
Access password	
Update	

4.2.2 Updating Configuration

After changed the configuration, click the "Update" button to update the parameters.

Item	Description
IP address	4 numbers separated by dots, assigned by the server under DHCP mode.
Subnet mask	4 numbers separated by dots, assigned by the server under DHCP mode.
Gateway address	4 numbers separated by dots, assigned by the server under DHCP mode.
DHCP client	If disable, then IP address · Subnet mask and Gateway address must be assigned manually.
Socket port of HTTP setup	If disable, then IP address, Subnet masks and Gateway address must be assigned manually.
Socket port of serial I/O	Port Number : any number between 1 and 65536,except 80 and 81 (which have been designated as the web pages) Socket Type : TCP Server, uses TCP protocol, passively waits for Client. TCP Client, uses TCP protocol, actively connects to Server. UDP Client, uses UDP protocol, exchanges packets with Server without connection.
Socket port of digital I/O	This is an extra I/O socket with similar configuration as the socket port of serial I/O, but the Port Number must be different Port Number : any number between 1 and 65536,except 80 and 81 (which have been designated as the web pages) Socket Type : TCP Server, uses TCP protocol, passively waits for Client. TCP Client, uses TCP protocol, actively connects to Server. UDP Client, uses UDP protocol, exchanges packets with Server without connection.
Destination IP address/ Socket port (TCP client and UDP)	The Server IP address under TCP client or UDP client mode.
Serial I/O settings (baud rate, parity,	Baud Rate : 300 – 115200 bps Parity & Data Bits : No Parity, 8 bits

data bits, stop bits)	Even Parity, 7 bits Odd Parity, 7 bits Stop Bit : 1 or 2				
Interface of serial I/O	RS232 : use only TxD and RxD to transfer and receive data. RS232 (RTS/CTS) : TxD, RxD – transfer and receive data RTS/CTS – flow control RS232 (RTS/CTS,DTR/DSR) : TxD, RxD – transfer and receive data RTS/CTS – flow control DTR – socket connection status, DSR – socket connection control RS485 (Half duplex) : half duplex RS422 (Full duplex) : full duplex				
Packet mode of serial input	If packet mode is disabled, the data received from the serial port will be transmitted immediately with minimal delay. If packet mode is enable, the data will be saved in the buffer memory first, and transmitted when the entire packet is received or when the buffer memory is full				
Packet mode inter-packet timeout	In packet mode, the time constant used to determine if the packet is finished, acceptable range is 10 to 1000 ms.				
Device ID	User assigned device ID number, acceptable range is 0 to 65535.				
Report device ID when connected	If this function is enabled, the device will report the device ID after the socket is connected. The format is : <table border="1" data-bbox="369 997 817 1117"> <tr> <td>Serial I/O socket</td> <td>nnnnnA[LF][CR]</td> </tr> <tr> <td>Digital I/O socket</td> <td>nnnnnB[LF][CR]</td> </tr> </table> <p>There are eight bytes : nnnnn is the 5-digit device ID, [LF] is decimal 10, and [CR] is decimal 13</p>	Serial I/O socket	nnnnnA[LF][CR]	Digital I/O socket	nnnnnB[LF][CR]
Serial I/O socket	nnnnnA[LF][CR]				
Digital I/O socket	nnnnnB[LF][CR]				
Setup password	The login password can be empty or 1 to 15 characters long. If the password is empty then no password is required for login.				
Access password	This is the password for socket connection. It can be empty or 1 to 15 characters long. If the password is empty then no password is required for login. If the password is not empty, then it must be entered immediately after socket connection is made. If the password is not entered within 10 seconds or a wrong password is entered, then it will				

automatically disconnect. If a wrong password is entered for three times in a row, no connection is allowed within 20 minutes.

After clicking on the "Update" button, the following screen will appear:



At this point the gateway is restarting with the new parameters. In about 5 seconds the system will return to the Login screen

5. Diagnosing the Data Gateway

5.1 Entering Setup

Make a null modem by connecting pin 2 and 3 together on a 9-pin male RS-232 connector. Plug the null modem on the Data Gateway's RS-232 connector.

Connect the Data Gateway onto the LAN, into the same subnet as the testing Host PC. Execute Hyperterm.exe. The following screen will appear.



Key in your favorite name and click the "OK" button. The following screen will appear.

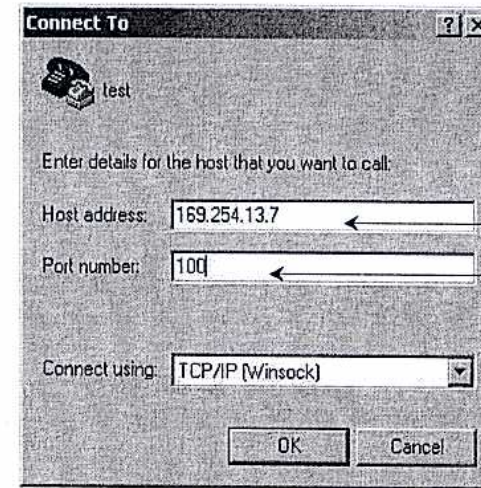

Enter IP Address and socket port of serial I/O. Make sure TCP/IP (Winsock) is selected and clicks the "OK" button. The following screen will appear.

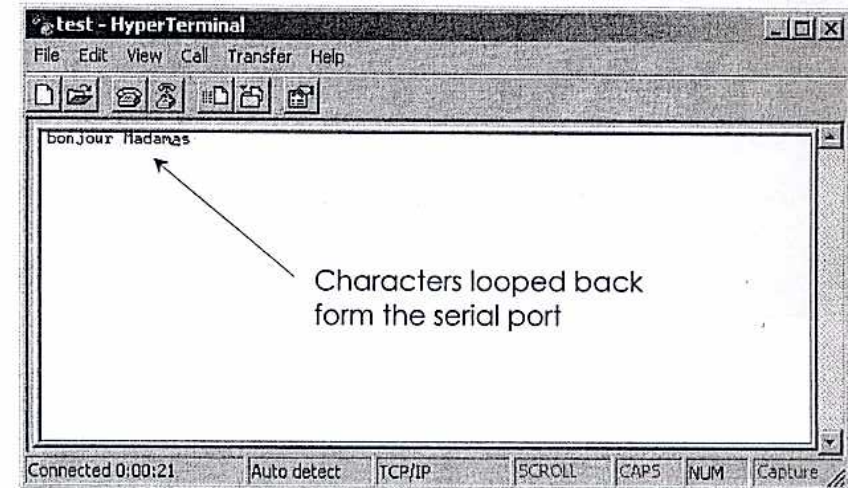

At this point you may type in a few test characters. These characters will be looped back through the null modem, and displayed on the screen. Note that 'Rx' will flash once whenever you type in a character, to indicate the receiving of

that character. You may also send a text file and it will be displayed on the screen. However, you should not use the "Send file" function because the transmission protocols such as Zmodem will cause Hyperterminal to reset the Ethernet Data Gateway.

5.2 Digital I/O

Connect gateway onto the LAN, into the same subnet as the testing PC. Execute Hypertrm.exe. Key in your favorite name and click the "OK" button.

Enter IP Address and socket port of digital I/O. Make sure TCP/IP (Winsock) is selected and clicks the "OK" button. The following screen will appear.



IP Address

Socket port of digital I/O

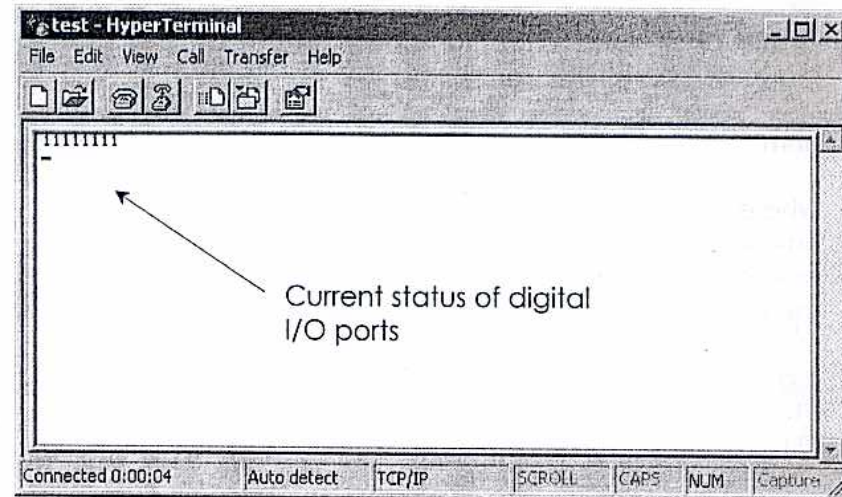

Select "File" / "Property" / "Configure" / "ASCII" and make the following settings.

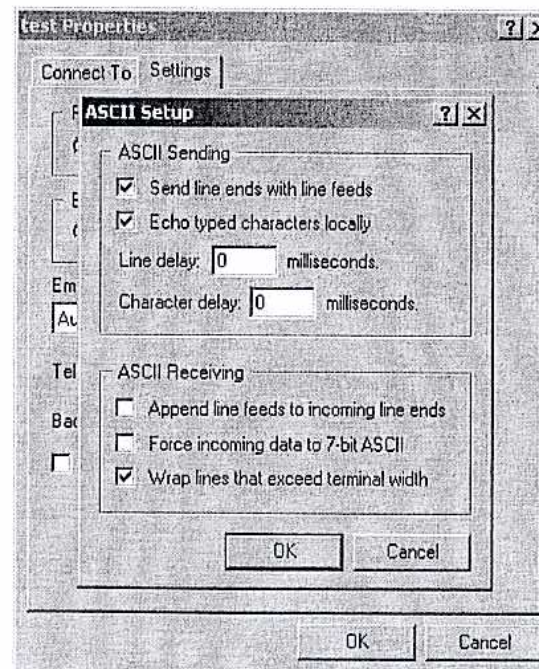

At this point you may key in command strings to change the digital I/O port state. For example:

nnm

where

nn=Output pin number

m = 0 or 1, 0 means to set the I/O pin to LOW, 1 means to set the I/O pin to HIGH.

e.g.

010 == change output #1 to low

011 == change output #1 to high

020 == change output #2 to low

021 == change output #2 to high

