

PIA-3410



High-speed Multi I/O Module

Description

The PIA-3410 is a high-speed Multi I/O module. It comes with two serial ports (RS-232 x 1, RS-232/485 x 1), one bidirectional printer port that supports SPP, ECP and EPP modes, an IDE HDD interface and a floppy disk controller.

The PIA-3410's industrial grade reliability lets it operate continuously at temperatures up to 60°C. The PIA-3410 can be setup using normal jumper settings or ,when used together with the PIA-3310 PC/104 386SX CPU Module, can be 100% configured in the BIOS setup

- **Chipset** : SMC FDC37C665GT
- **I/O configuration** : by jumpers or in BIOS (of PIA-3310)
- **Bus interface**: PC/104
- **IDE HDD interface** : supports up to two IDE (AT bus) hard disk drives.
- **FDD interface** : supports up to two FDD, 5¼ (360 KB and 1.2 MB) and / or 3½ (720 KB and 1.44 MB)
- **Enhanced bidirectional parallel port** : supports EPP/ECP/SPP
- **Serial ports** : one RS-232 and one RS-232/485 port, jumper selectable. Both channels with 16C550 compatible UARTs with 16-byte FIFO for speeds up to 115.2 Kbps

Power requirements:

- Single 5V @ 320 mA

Physical and Environmental

- Dimensions : 95 x 90 mm
- Weight : 100 gram
- Operating temperature: 0 ~ +60°C
- Storage temperature : -25 ~ +80°C
- Relative humidity: 0 ~ 90% non-condensing

Board Layout

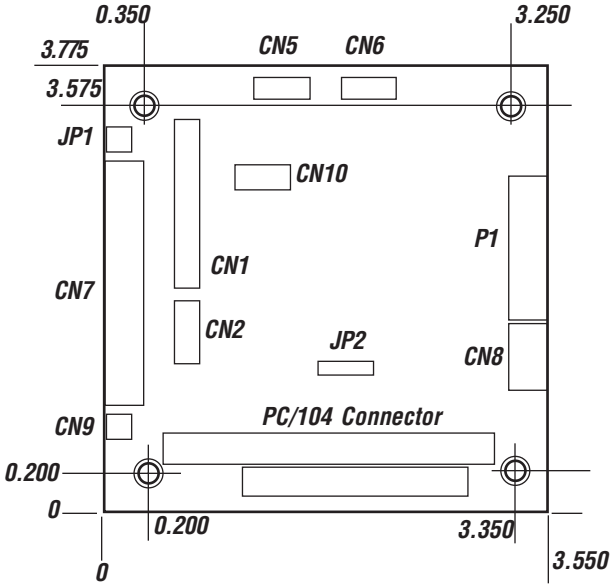

- | | |
|-------------------------------|-------------------------------------|
| CN1 : FDD connector | JP1 : IDE LED |
| CN2 : RS-232 COM2 | JP2 : RS-232/485 select |
| CN5 : IRQ select COM1 | P1 : Parallel port connector |
| CN6 : IRQ select COM2 | |
| CN7 : IDE connector | |
| CN8 : RS-232 COM1 | |
| CN9 : RS-485 COM2 | |
| CN10 : ECP, DMA select | |

(dimensions in inches, not to scale)

Serial Port setup (CN 5/6/8/9 and JP2)

The PIA-3410 offers two serial ports: one RS-232 and one RS232/485. These ports let you connect to serial devices (mouse, printers, etc.), or to a communication network.

The PIA-3410 serial ports can be setup using normal jumper settings or, when used together with the PIA-3310 PC/104 386SX CPU Module, can be configured in the BIOS setup of the CPU Module. For BIOS setup see PIA-3310 manual.

COM 1 RS-232 port (CN8)

The primary serial port connector, a 10-pin, dual-in-line, male header is located on the right side of the module.

COM 2 RS-232 (CN2)

The secondary serial port connector, a 10-pin, dual-in-line, male header is located on the left bottom side of the module. The connector is only to be used for RS-232 operation. For the RS-485 function a separate header is placed.

COM 2 RS-485 (CN9)

The secondary serial port for the RS-485 option, a 2-pin, male header is located on the left side of the module below the IDE port. The connector is only to be used for RS-485 operation.

COM1 and COM2 Interrupt Settings (CN5, CN6)

CN5 controls the interrupt for COM1 and CN6 controls the interrupt for COM2

COM1 RS-232

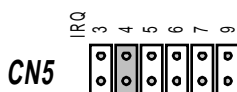

COM2 RS-232/485

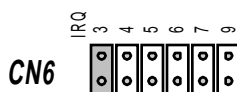

RS-232/485 Mode Selection (JP2)

COM2 offers you the option to be used either in RS-232 or RS-485 mode. A 3-pin header located on the center of the board near the PC/104 connector let you configure this option.

JP 2

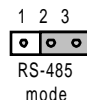
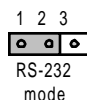

Parallel Port setup (CN10)

The port interrupt for the parallel port is fixed at IRQ5. The port support SPP, EPP and ECP mode. In ECP mode you can select the DMA channel you wish your high speed communication to traverse through.

Jumpers on jumper block 2 control DMA channel setting in ECP mode.

- DMA 1 (both left two pins closed)
- DMA 2 (both right two pins closed)

JP 2

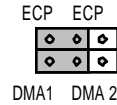

Harddisk and FDD setup

Setup of your harddisk and floppy disk drive is done in the BIOS setup program of your CPU module or CPU card. Note that the PIA-3410 is only supported by standard BIOS (not enhanced). Harddisk setup parameters have to be entered by hand, no auto-detect function.

Pin Assignments

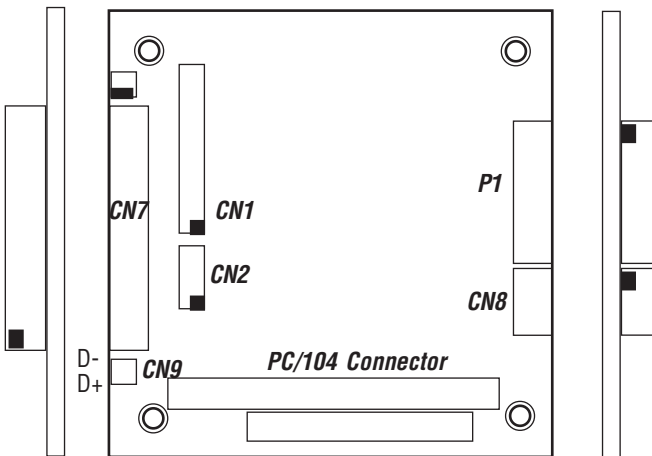

■ = Position of number 1 pin on connectors

Parallel Printer Connector (P1)

Pin	Name	Pin	Name
1	Strobe#	14	Auto Form Feed
2	D0	15	Error#
3	D1	16	Initialize
4	D2	17	Printer Select In
5	D3	18	GND
6	D4	19	GND
7	D5	20	GND
8	D6	21	GND
9	D7	22	GND
10	Acknowledge	23	GND
11	Busy	24	GND
12	Paper Empty	25	GND
13	Printer Select	26	NC

RS-232 Serial Port COM1 (CN8)

Pin	Name
1	Data Carrier Detect (DCD)
2	Receive Data (RxD)
3	Transmit Data (TxD)
4	Data Terminal Ready (DTR)
5	Ground (GND)
6	Data Set Ready (DSR)
7	Request To Send (RTS)
8	Clear To Send (CTS)
9	Ring Indicator (RI)

RS-232 Serial Port COM2 (CN2)

Pin	Name
1	Data Carrier Detect (DCD)
2	Receive Data (RxD)
3	Transmit Data (TxD)
4	Data Terminal Ready (DTR)
5	Ground (GND)
6	Data Set Ready (DSR)
7	Request To Send (RTS)
8	Clear To Send (CTS)
9	Ring Indicator (RI)

RS-485 Serial Port COM2 (CN9)

Pin	Name
1	Data +
2	Data -

HDD LED (JP1)

Pin	Name
1	+
2	-

IDE Hard Drive Connector (CN1)

Pin	Name	Pin	Name
1	-RESET	2	GND
3	IDED7	4	HD8
5	HD6	6	HD9
7	HD5	8	HD10
9	HD4	10	HD11
11	HD3	12	HD12
13	HD2	14	HD13
15	HD1	16	HD14
17	HD0	18	HD15
19	GND	20	NC
21	NC	22	GND
23	-IOW	24	GND
25	-IOR	26	GND
27	IORDY	28	IDEALE
29	NC	30	GND
31	IRQ14	32	-IOCS16
33	IDEA1	34	NC
35	IDEA0	36	IDEA2
37	-HDCS0	38	-HDCS1
39	HDDLED	40	GND

3.2 Floppy Drive Connector (CN2)

Pin	Name	Pin	Name
1	GND	2	RM/LC
3	GND	4	NC
5	GND	6	NC, DRATE0
7	GND	8	-INDEX
9	GND	10	-MTR0
11	GND	12	-DRV1
13	GND	14	-DRV0
15	GND	16	-MTR1
17	GND	18	DIR
19	GND	20	-STEP
21	GND	22	-WD
23	GND	24	-WG
25	GND	26	-TRK0
27	GND	28	-WP
29	GND, DRATE1/MEDIA_ID1	30	-RDATA
31	GND	32	HDSEL
33	GND, MEDIA_ID0	34	DSKCHG

Warranty

This product is warranted to be in good working order for a period of one year from the date of purchase. Should this product fail to be in good working order at any time during this period, we will, at our option, replace or repair it at no additional charge except as set forth in the following terms. This warranty does not apply to products damaged by misuse, modifications, accident or disaster.

Vendor assumes no liability for any damages, lost profits, lost savings or any other incidental or consequential damage resulting from the use, misuse of, or inability to use this product. Vendor will not be liable for any claim made by any other related party.

Return authorization must be obtained from the vendor before returned merchandise will be accepted. Authorization can be obtained by calling or faxing the vendor and requesting a Return Merchandise Authorization (RMA) number. Returned goods should always be accompanied by a clear problem description.

