

# **Neosys Technology Inc.**

**Nuvo-6108GC Series**

## **User Manual**

Revision 1.0

# Table of Contents

<b>Table of Contents</b> .....	<b>2</b>
<b>Legal Information</b> .....	<b>4</b>
<b>Contact Information</b> .....	<b>5</b>
<b>Declaration of Conformity</b> .....	<b>5</b>
<b>Copyright Notice</b> .....	<b>6</b>
<b>Safety Precautions</b> .....	<b>7</b>
<b>Service and Maintenance</b> .....	<b>8</b>
<b>ESD Precautions</b> .....	<b>8</b>
<b>About This Manual</b> .....	<b>9</b>

## 1 Introduction

<b>1.1 Product Specifications</b> .....	<b>11</b>
<b>1.2 Dimension</b> .....	<b>13</b>
1.2.1 I/O Panel View .....	13
1.2.2 Removable Side Panel View .....	14
1.2.3 I/O Panel View with Damping Bracket Installed .....	15
1.2.4 Bottom View with Damping Bracket Installed .....	16

## 2 System Overview

<b>2.1 Nuvo-6108GC Packing List</b> .....	<b>17</b>
<b>2.2 External I/O</b> .....	<b>18</b>
2.2.1 Reset Button .....	20
2.2.2 Power Button .....	21
2.2.3 Speaker-out 3.5mm Jack .....	22
2.2.4 LED Indicators .....	23
2.2.5 USB 3.0 Port .....	24
2.2.6 GbE Port .....	25
2.2.7 DVI Port .....	26
2.2.8 COM Port .....	27
2.2.9 3-Pin Terminal Block for DC Input .....	29
2.2.10 3-Pin Remote On/ Off .....	30
<b>2.3 Internal I/O Functions</b> .....	<b>31</b>
2.3.1 Status LED Output & Remote On/ Off Control and Pin Definition .....	31
2.3.2 Dual DRAM SODIMM Slot .....	33
2.3.3 mini-PCIe Slot and Pin Definition .....	34
2.3.4 M.2 (B Key) and SIM Card Slot .....	36
2.3.5 SATA Port 1 .....	38
2.3.6 SATA Ports 2, 3 and 4 .....	39
2.3.7 Internal USB Port on Extension Board .....	40
2.3.8 PCIe 8-Pin and 6-Pin 12V VDC Power Connector .....	41
2.3.9 X16/ x8 PCI Express Slots .....	42

## 3 System Installation

<b>3.1 Disassembling the System</b> .....	<b>44</b>
<b>3.2 Installing Internal Components</b> .....	<b>50</b>
3.2.1 CPU Installation Procedure .....	50
3.2.2 DDR4 SO-DIMM Installation .....	54
3.2.3 M.2 Module, SIM Card and Antennae Installation .....	56
3.2.4 mini-PCIe Module and Antennae Installation .....	58
3.2.5 Installing HDD/ SSD to SATA Port 1 .....	60
3.2.6 Installing HDD/ SSD to SATA Ports 2/ 3/ 4 .....	62
3.2.7 PCI/ PCIe Add-on Card Installation .....	64
<b>3.3 Installing the System Enclosure</b> .....	<b>68</b>
<b>3.4 Anti-vibrate Grommet/ Wall Mount Bracket Installation</b> .....	<b>71</b>

<b>4</b>	<b>System Configuration</b>	
<b>4.1</b>	<b>BIOS Settings</b>	<b>72</b>
4.1.1	COM1 & COM2 Configuration	73
4.1.2	SATA Configuration	74
4.1.3	TPM Availability	76
4.1.4	Auto Wake on S5	77
4.1.5	Power On After Power Failure Option	78
4.1.6	Power & Performance (CPU SKU Power Configuration)	79
4.1.7	Wake on LAN Option	80
4.1.8	Boot Menu	81
4.1.9	Boot Type (Legacy/ UEFI)	83
4.1.10	Position New Boot Device	85
4.1.11	Watchdog Timer for Booting	86
4.1.12	Legacy/ UEFI Boot Device	87
<b>4.2</b>	<b>AMT Configuration</b>	<b>88</b>
<b>4.3</b>	<b>RAID Configuration</b>	<b>90</b>
<b>5</b>	<b>OS Support and Driver Installation</b>	
<b>5.1</b>	<b>Operating System Compatibility</b>	<b>92</b>
<b>5.2</b>	<b>Driver Installation</b>	<b>93</b>
5.2.1	Install Drivers Automatically	93
5.2.2	Install Drivers Manually	94
<b>5.3</b>	<b>Driver Installation for Watchdog Timer Control</b>	<b>95</b>
	<b>Appendix A Using WDT &amp; DIO</b>	
	<b>WDT and DIO Library Installation</b>	<b>97</b>
	<b>WDT Functions</b>	<b>99</b>
	InitWDT	99
	SetWDT	99
	StartWDT	100
	ResetWDT	100
	StopWDT	100

# Legal Information

All Neosys Technology Inc. products shall be subject to the latest Standard Warranty Policy

Neosys Technology Inc. may modify, update or upgrade the software, firmware or any accompanying user documentation without any prior notice. Neosys Technology Inc. will provide access to these new software, firmware or documentation releases from download sections of our website or through our service partners.

Before installing any software, applications or components provided by a third party, customer should ensure that they are compatible and interoperable with Neosys Technology Inc. product by checking in advance with Neosys Technology Inc.. Customer is solely responsible for ensuring the compatibility and interoperability of the third party's products. Customer is further solely responsible for ensuring its systems, software, and data are adequately backed up as a precaution against possible failures, alternation, or loss.

For questions in regards to hardware/ software compatibility, customers should contact Neosys Technology Inc. sales representative or technical support.

To the extent permitted by applicable laws, Neosys Technology Inc. shall NOT be responsible for any interoperability or compatibility issues that may arise when (1) products, software, or options not certified and supported; (2) configurations not certified and supported are used; (3) parts intended for one system is installed in another system of different make or model.

# Contact Information

---

**Headquarters**  
**(Taipei, Taiwan)**      **Neosys Technology Inc.**  
15F, No.868-3, Zhongzheng Rd., Zhonghe Dist., New Taipei City, 23586, Taiwan  
Tel: +886-2-2223-6182 Fax: +886-2-2223-6183 [Email](#), [Website](#)

---

**Americas**  
**(Illinois, USA)**      **Neosys Technology America Inc.**  
3384 Commercial Avenue, Northbrook, IL 60062, USA  
Tel: +1-847-656-3298 [Email](#), [Website](#)

---

**China**      **Neosys Technology (China) Ltd.**  
Room 612, Building 32, Guiping Road 680, Shanghai  
Tel: +86-2161155366 [Email](#), [Website](#)

---

# Declaration of Conformity

**FCC**      This equipment has been tested and found to comply with the limits for a Class A digital device, pursuant to part 15 of the FCC Rules. These limits are designed to provide reasonable protection against harmful interference when the equipment is operated in a commercial environment. This equipment generates, uses, and can radiate radio frequency energy and, if not installed and used in accordance with the instruction manual, may cause harmful interference to radio communications. Operation of this equipment in a residential area is likely to cause harmful interference in which case the user will be required to correct the interference at own expense.

---

**CE**      The product(s) described in this manual complies with all applicable European Union (CE) directives if it has a CE marking. For computer systems to remain CE compliant, only CE-compliant parts may be used. Maintaining CE compliance also requires proper cable and cabling techniques.

# Copyright Notice

All rights reserved. This publication may not be reproduced, transmitted, transcribed, stored in a retrieval system, or translated into any language or computer language, in any form or by any means, electronic, mechanical, magnetic, optical, chemical, manual or otherwise, without the prior written consent of Neosys Technology, Inc.

---

## **Disclaimer**

This manual is intended to be used as an informative guide only and is subject to change without prior notice. It does not represent commitment from Neosys Technology Inc. Neosys Technology Inc. shall not be liable for any direct, indirect, special, incidental, or consequential damages arising from the use of the product or documentation, nor for any infringement on third party rights.

---

## **Patents and Trademarks**

Neosys, the Neosys logo, Expansion Cassette, MezIO™ are registered patents and trademarks of Neosys Technology, Inc.

Windows is a registered trademark of Microsoft Corporation.

Intel®, Core™ are registered trademarks of Intel Corporation

NVIDIA®, GeForce® are registered trademarks of NVIDIA Corporation

All other names, brands, products or services are trademarks or registered trademarks of their respective owners.

# Safety Precautions

Read these instructions carefully before you install, operate, or transport the system.

Install the system or DIN rail associated with, at a sturdy location

Install the power socket outlet near the system where it is easily accessible

Secure each system module(s) using its retaining screws

Place power cords and other connection cables away from foot traffic. Do not place items over power cords and make sure they do not rest against data cables

Shutdown, disconnect all cables from the system and ground yourself before touching internal modules

Ensure that the correct power range is being used before powering the device

Should a module fail, arrange for a replacement as soon as possible to minimize down-time

If the system is not going to be used for a long time, disconnect it from mains (power socket) to avoid transient over-voltage

# Service and Maintenance

ONLY qualified personnel should service the system

Shutdown the system, disconnect the power cord and all other connections before servicing the system

When replacing/ installing additional components (expansion card, memory module, etc.), insert them as gently as possible while assuring proper connector engagement

## ESD Precautions

Handle add-on module, motherboard by their retention screws or the module's frame/ heat sink. Avoid touching the PCB circuit board or add-on module connector pins

Use a grounded wrist strap and an anti-static work pad to discharge static electricity when installing or maintaining the system

Avoid dust, debris, carpets, plastic, vinyl and styrofoam in your work area.

Do not remove any module or component from its anti-static bag before installation



# About This Manual

This guide introduces Neosys Nuvo-6108GC system. An industrial grade GPU computer integrating high-end NVIDIA® GeForce® with Intel® Xeon® E3 v5 or 6th Gen Core™ processors.

The guide also demonstrates the system's basic installation procedures.

## Revision History

Version	Date	Description
1.0	Mar. 2018	Initial release

# 1 Introduction

The Neosys Nuvo-6108GC is the world's first industrial-grade GPU computer integrating NVIDIA® GeForce® GTX 1070, 1080 or TITAN X and an Intel Xeon processor.

The perfect replacement for massive rackmount IPC systems, Nuvo-6108GC is powered by Intel® Xeon® E3 v5 or 6<sup>th</sup> Gen Core™ processor with C236 chipset, supports up to 32GB of ECC/ non-ECC DDR4 memory and has rich I/O ports such as Gigabit Ethernet, USB3.0, video ports and serial ports. In addition to the x16 PCIe port for GPU installation, there are two x8 PCIe expansion slots for additional devices or other application means.

In order to sustain high GPU performance in industrial environments, Nuvo-6108GC features patented cold air intake design to effectively dissipate heat generated by the graphics card. The unique design guarantees operation at 60°C with 100% GPU loading and ensures Nuvo-6108GC's reliability for demanding field use. In



addition, Nuvo-6108GC comes with patented shock/ vibration absorption mounting brackets to ensure the system's smooth operation under harsh environments.

“GPU computing is a popular emerging technology and has been a hot topic in the last five years. Nuvo-6108GC is Neosys' response to advanced GPU-accelerated computing and is applicable to applications such as artificial intelligence, virtual reality, autonomous driving and CUDA computing.

## 1.1 Product Specifications

<b>System Core</b>	
Processor	Supports Intel® Xeon® E5 v3 and 6th-Gen Core™ LGA1151 CPU - Intel® Xeon® Processor E3-1275 v5 (8M Cache, 3.6/4.0 GHz)* - Intel® Xeon® Processor E3-1268L v5 (8M Cache, 2.4/3.4 GHz) - Intel® Core™ i7-6700 (8M Cache, 3.4/4.0 GHz)* - Intel® Core™ i5-6500 (6M Cache, 3.2/3.6 GHz)* - Intel® Core™ i7-6700TE (8M Cache, 2.4/ 3.4 GHz) - Intel® Core™ i7-6500TE (6M Cache, 2.3/3.3 GHz)
Chipset	Intel® C236 platform controller hub
Graphics	Independent GPU (up to 250W TDP) via x16 PEG port or integrated Intel® HD 530 graphics
Memory	Up to 32 GB ECC/ non-ECC DDR4-2133
<b>I/O Interface</b>	
Ethernet	1x Gigabit Ethernet port by Intel I219-LM 1x Gigabit Ethernet port by Intel I210-IT
Video Port	2x DVI-D connectors supporting 1920x1200 resolution
Serial Port	2x Software-programmable RS-232/422/485 ports
USB	4x USB 3.0 ports 1x USB 2.0 port (internal daughterboard)
Audio	1x Speaker-out
<b>Expansion Bus</b>	
PCI Express	1x PCIe x16 slot @ Gen3, 16-lanes PCIE signals for GPU 2x PCIe x8 slot @ Gen3, 4-lanes PCIE signals
M.2	1x M.2 B key socket for 3G/ 4G options with SIM socket
mini-PCIe	1x full-size mini-PCI Express socket
Remote Ctrl. & Status Output	1x 2x6-pin 2.0mm pin-header connector for remote on/off control and status LED output
<b>Storage Interface</b>	
SATA HDD	4x Internal SATA ports for 2.5" HDD/SSD installation, supporting RAID 0/ 1/ 5/ 10
<b>Power Supply</b>	
DC Input	1x 3-pin pluggable terminal block for 24VDC input
Remote ctrl.	1x 3-pin pluggable terminal block for remote on/off control

Max. Power Consumption	<p>With E3-1268L v5: 50.16W@24VDC</p> <p>With i7-6700TE (35W TDP): 53.76W@24VDC</p> <p>With i5-6500TE (35W TDP): 35.04W@24VDC</p> <p>With i3-6500TE (Max. TDP): 58.08W@24VDC</p>
<b>Mechanical</b>	
Dimension	164 mm (W) x 360 mm (D) x 174 mm (H)
Weight	Approx. 4.7 kg (including CPU, memory, HDD)
Mounting	Wall-mounting with damping bracket (Standard)
<b>Environmental</b>	
Temperature	<p>Storage: -40°C ~ 85°C</p> <p>Operating: -25°C ~ 60°C, 100% CPU loading */**</p>
Humidity	10%~90% , non-condensing
Vibration	Operating, 1.0Grms, 5-500 Hz, 3 Axes (w/ GPU, fan, HDD and damping bracket installed, according to IEC60068-2-64)
EMC	CE/FCC Class A, according to EN 55022 & EN 55024

## 1.2 Dimension

### 1.2.1 I/O Panel View

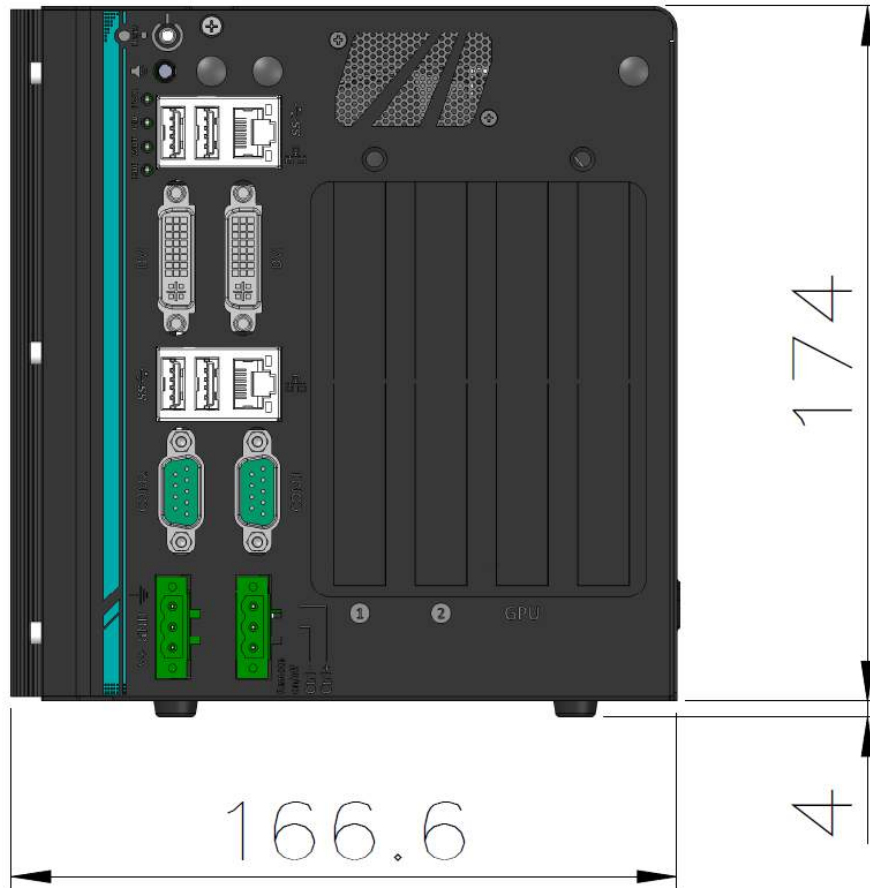

#### NOTE

*All measurements are in millimeters (mm).*

### 1.2.2 Removable Side Panel View

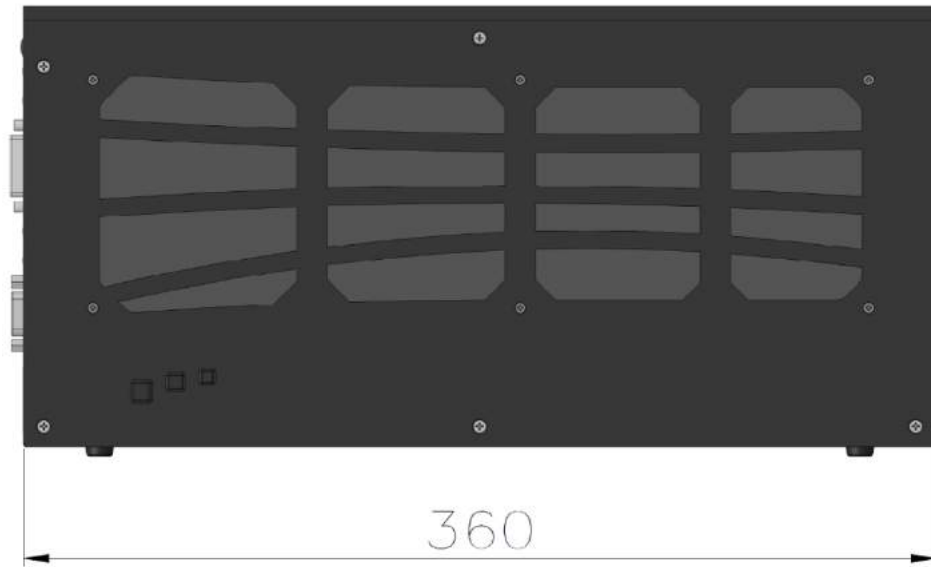

#### NOTE

*All measurements are in millimeters (mm).*

### 1.2.3 I/O Panel View with Damping Bracket Installed

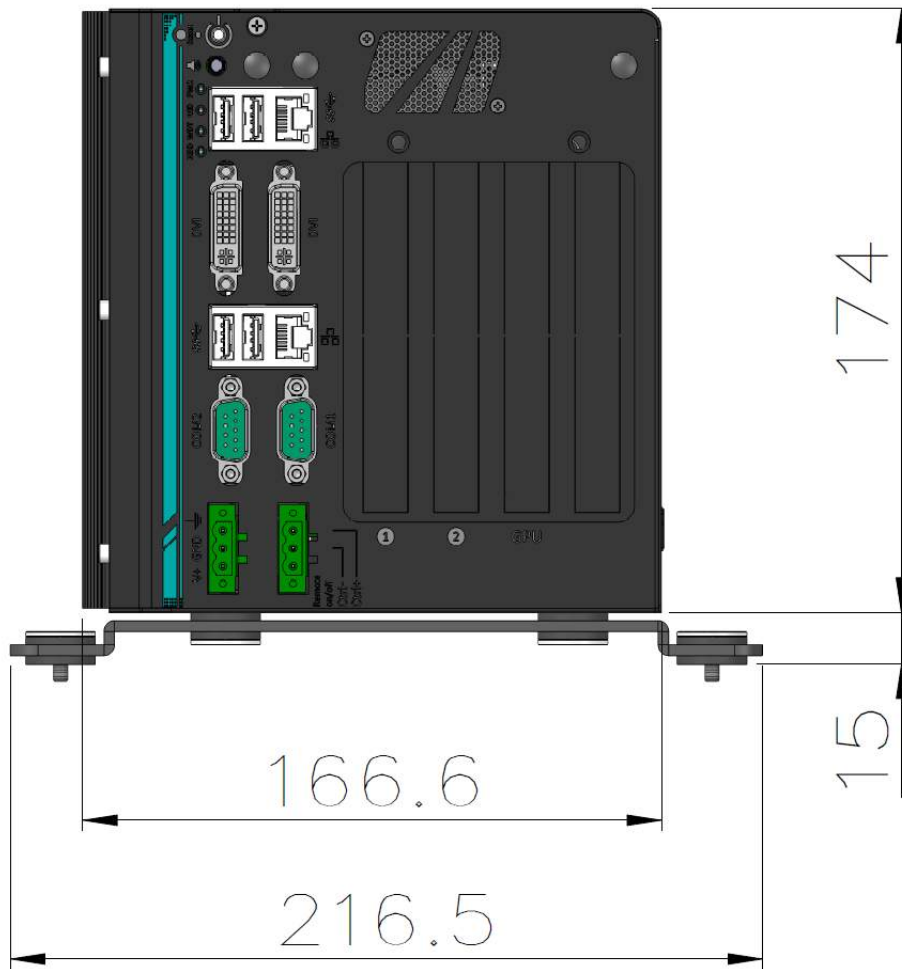

#### NOTE

*All measurements are in millimeters (mm).*

### 1.2.4 Bottom View with Damping Bracket Installed

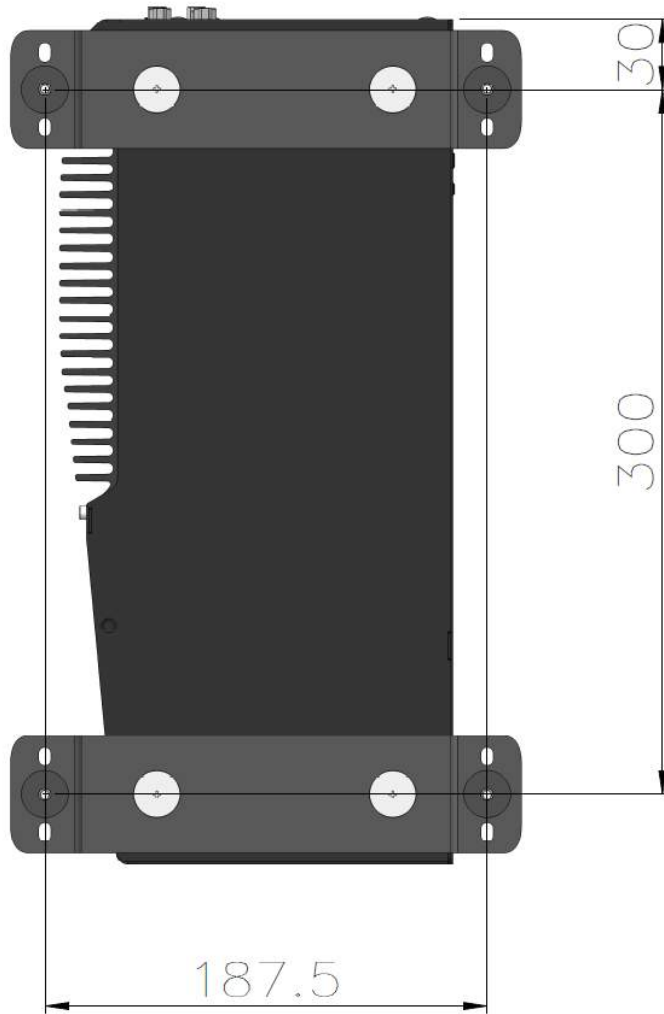

**NOTE**

*All measurements are in millimeters (mm).*



## 2 System Overview

Upon receiving and unpacking your Nuvo-6180GC, please check immediately if the package contains all the items listed in the following table. If any item(s) are missing or damaged, please contact your local dealer or Neosys Technology.

### 2.1 Nuvo-6180GC Packing List

System Pack	Nuvo-6180GC	Qty
1	Nuvo-6180GC (If you ordered CPU/ RAM/ HDD, please verify these items)	1
2	Accessory box, which contains <ul style="list-style-type: none"> <li>● SATA HDD/ SSD bracket</li> <li>● Neosys drivers &amp; utilities DVD</li> <li>● Damping bracket for in-vehicle deployment</li> <li>● Shock-absorbing grommet</li> <li>● 3-pin power terminal block</li> <li>● Screw pack</li> </ul>	1 2 2 8 1 1

## 2.2 External I/O

The Nuvo-6108GC I/O panel features dual gigabit Ethernet, four USB3.0, dual DVI ports (off motherboard chipset), dual serial ports, 3-pin terminal and 3-pin on/ off control.

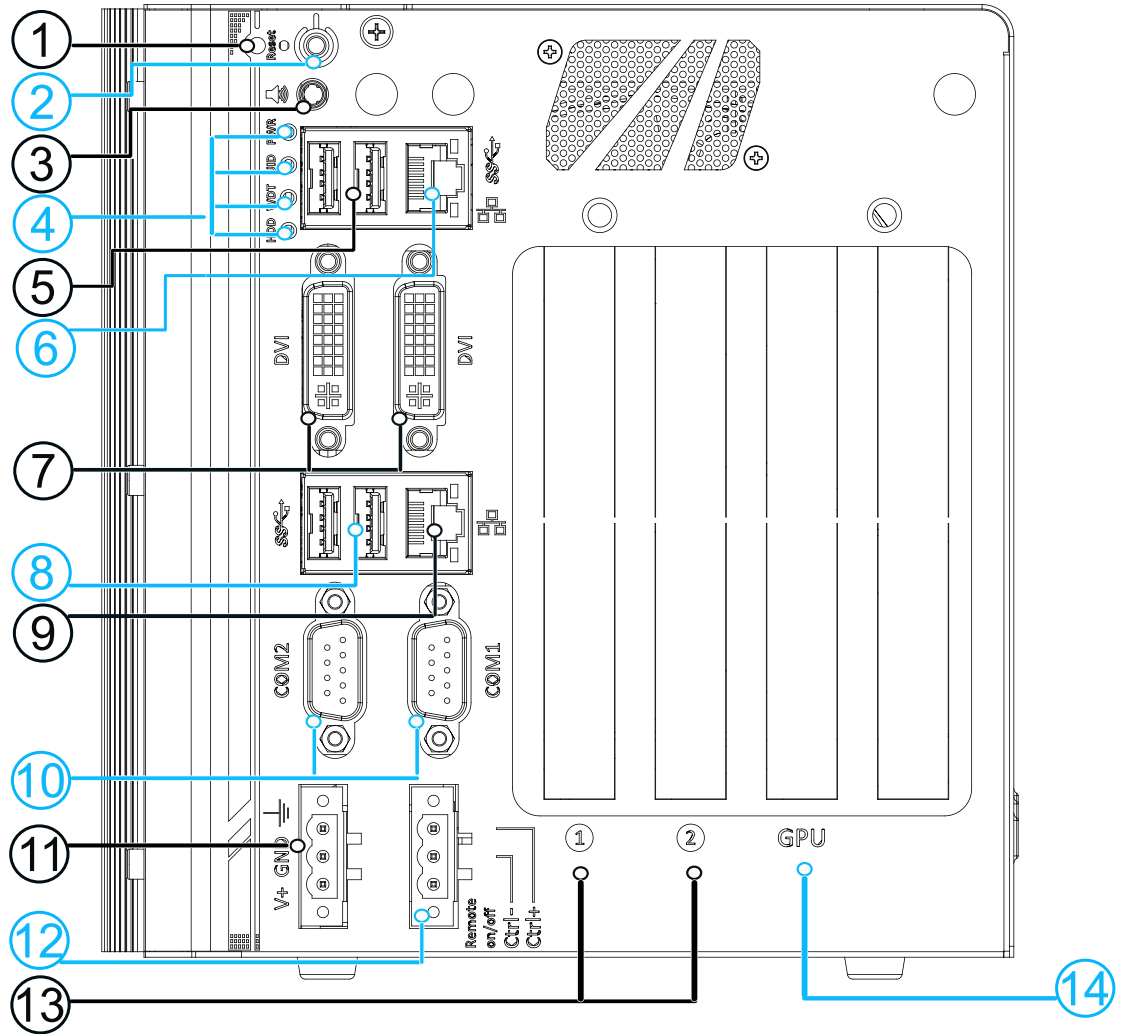

No.	Item	Description
1	<a href="#">Reset button</a>	Use this button to manual reset the system.
2	<a href="#">Power button</a>	Use this button to turn on or shutdown the system.
3	<a href="#">Speaker-out 3.5mm jack</a>	Speaker-out jack for sound output.
4	<a href="#">LED indicator</a>	From top to bottom, the four system LEDs are PWR (system power), UID (reserved LED), WDT (watchdog timer) and HDD (hard disk drive).
5	<a href="#">USB 3.0 port</a>	USB 3.0 port supports up to 5 Gbit/s data transfer bandwidth.

6	<a href="#">GbE port</a>	Implemented via Intel I219-LM, the Gigabit Ethernet port offers fast network access.
7	<a href="#">DVI port</a>	DVI-D output supports resolution up to 1920x1200@60Hz and is compatible with other digital connections via an adapter.
8	<a href="#">USB 3.0 port</a>	USB 3.0 port supports up to 5 Gbit/s data transfer bandwidth.
9	<a href="#">GbE port</a>	Implemented via Intel I210-LM, the Gigabit Ethernet port offers fast network access.
10	<a href="#">COM port</a>	The software-selectable RS-232/422/485 ports. The operation mode of COM1 and COM2 can be set in BIOS.
11	<a href="#">3-pin terminal block</a>	The system accepts 24V DC power input.
12	<a href="#">3-pin Remote on/ off control</a>	Allows for external switch extension when the system is placed inside a cabinet.
13	PCIe x8	PCIe x8 expansion slots
14	PCIe x16	One PCIe x16 slot for graphics card installation

## 2.2.1 Reset Button

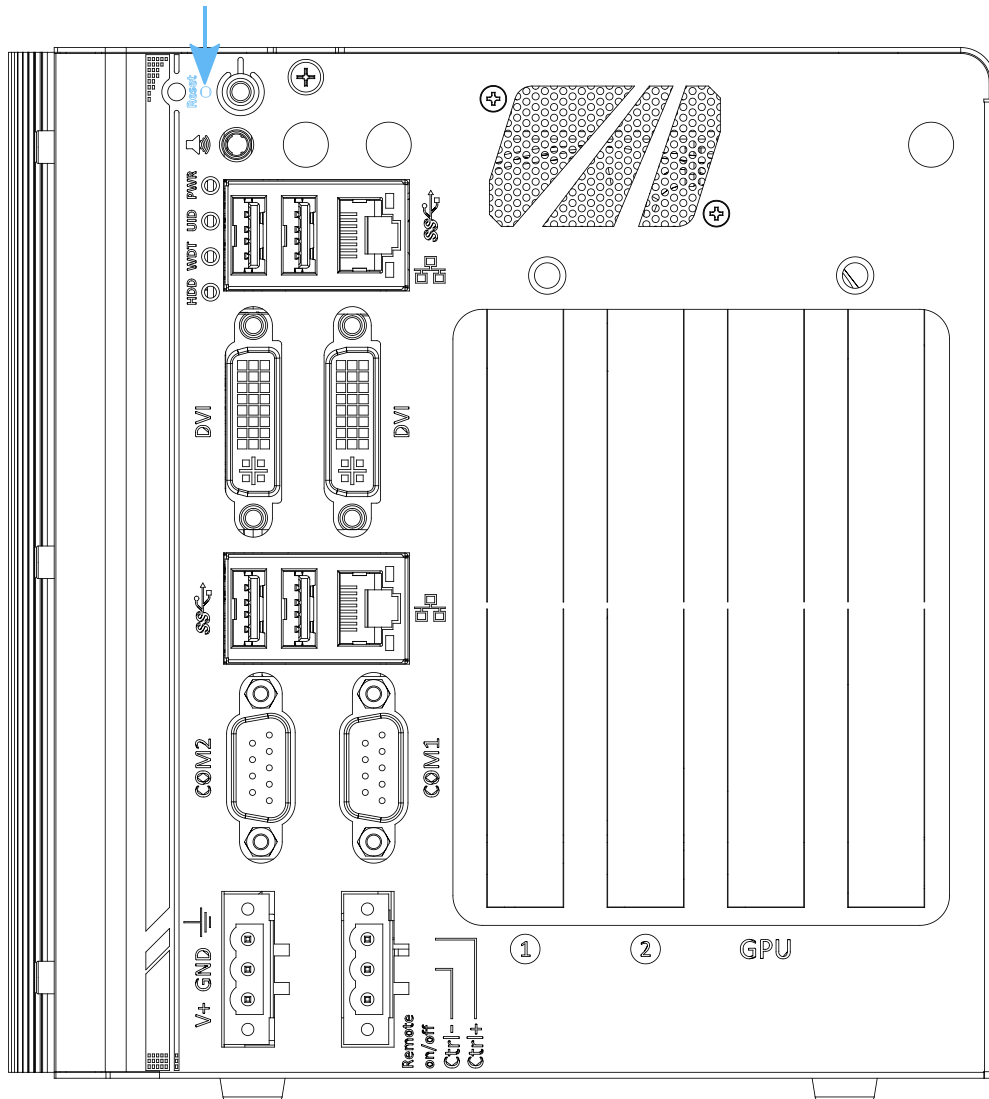

The reset button is used to manually reset the system in case of system halt or malfunction. To avoid unexpected reset, the button is purposely placed behind the panel. To reset, please use a pin-like object (eg. tip of a pen) to access the reset button.

## 2.2.2 Power Button

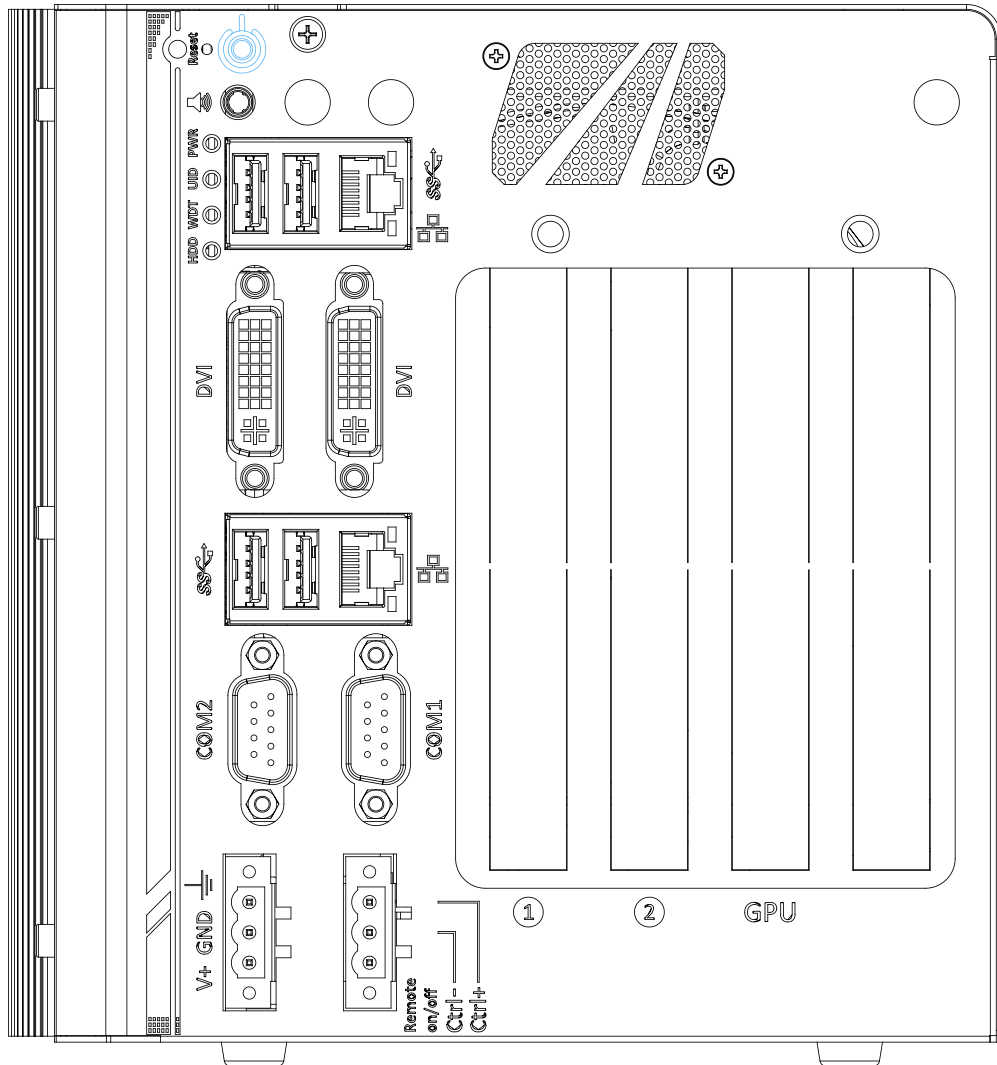

The power button is a non-latched switch for ATX mode on/off operation. To turn on the Nuvo-6180GC series, press the power button and the PWR LED should light-up green. To turn off Nuvo-6180GC, issuing a shutdown command in OS is preferred, or you can simply press the power button. To force shutdown when the system freezes, press and hold the power button for 5 seconds. Please note that there is a 5-second interval between on/off operations (i.e. once turning off the system, there is a 5-second wait before you can power-on the system).

### 2.2.3 Speaker-out 3.5mm Jack

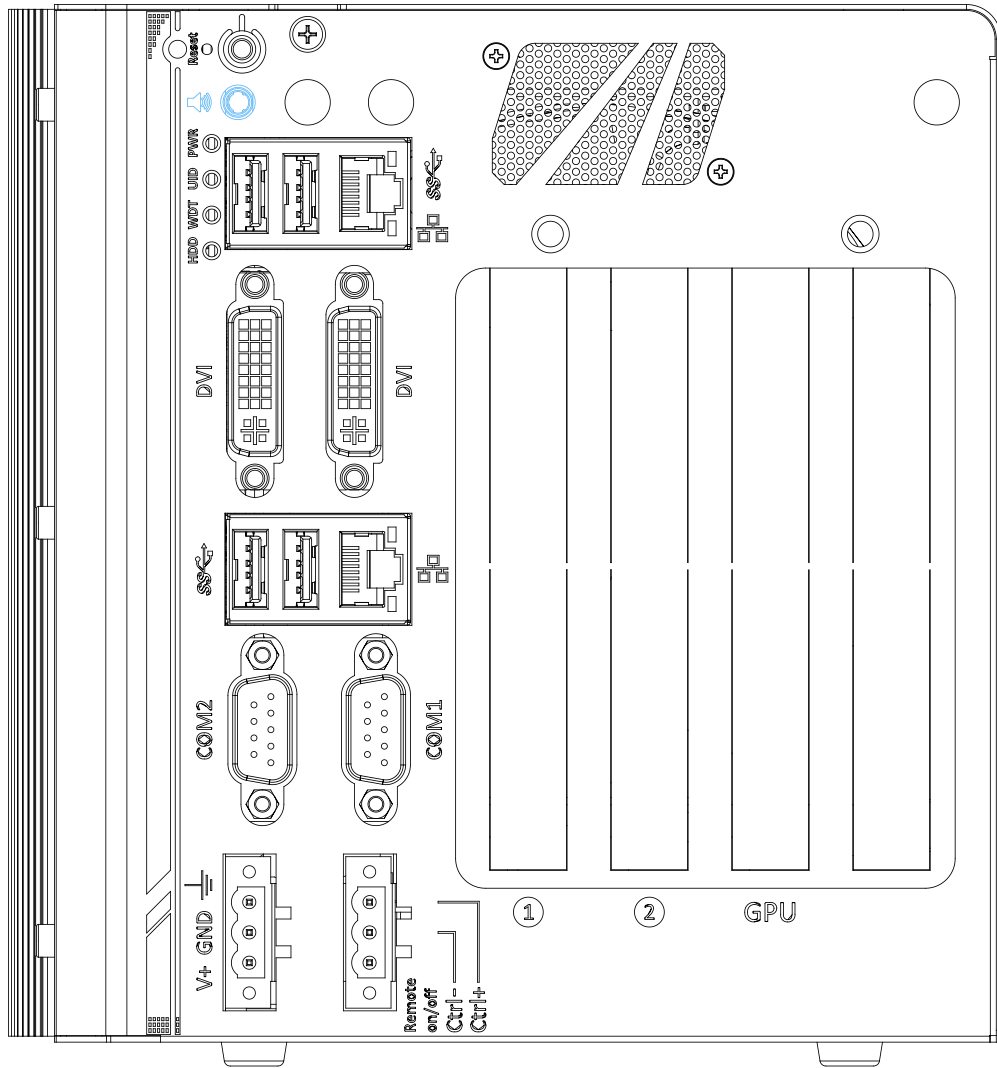

The system's audio output is provided via Intel® High Definition Audio (built-in in H110 PCH) and Realtek ALC262 codec. The  port is used for speaker / headphone output. To utilize the audio function in Windows, you need to install corresponding drivers for both Intel® H110 PCH and Realtek ALC262 codec. Please refer to the driver installation section.

## 2.2.4 LED Indicators

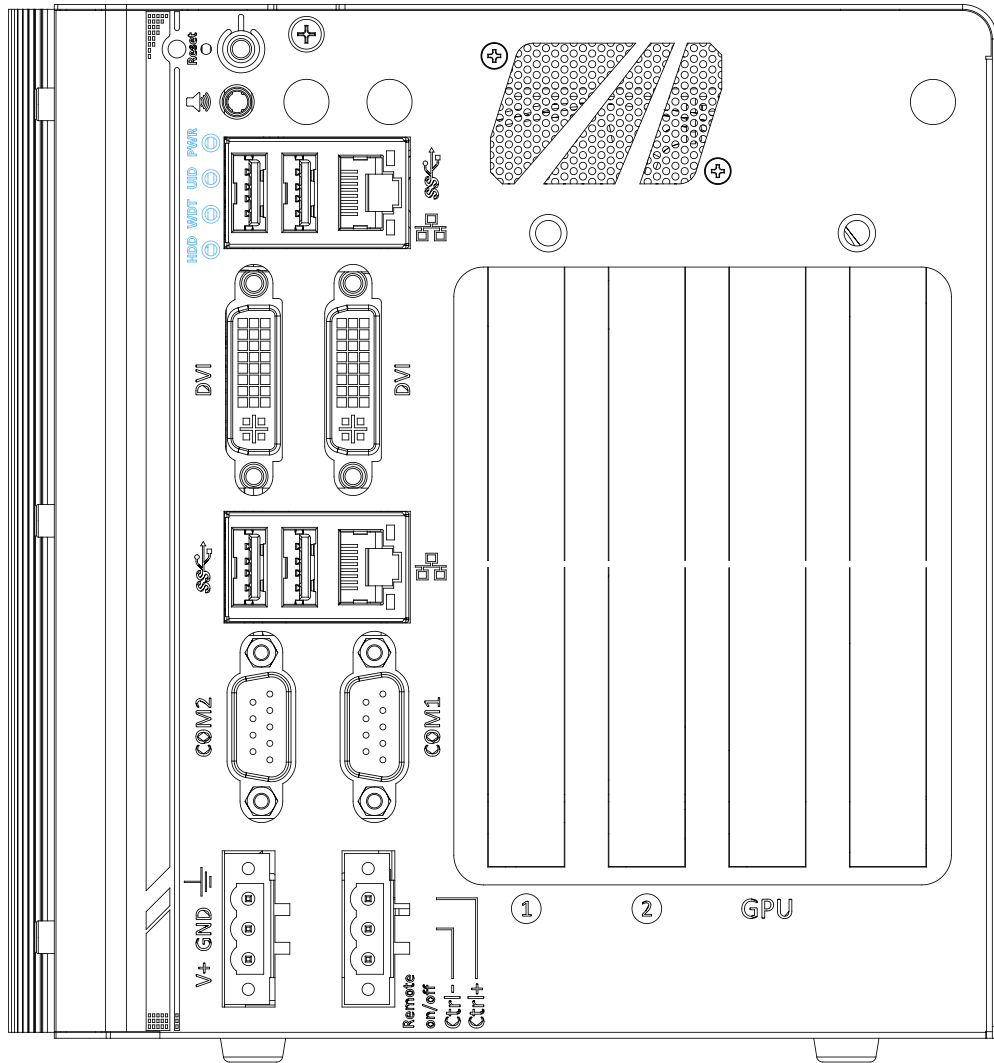

There are four LED indicators on the I/O panel: PWR, UID, WDT and HDD. The descriptions of these three LED are listed in the following table.

Indicator	Color	Description
PWR	Green	Power indicator, lid when system is on.
UID	Green	Reserved for future usage.
WDT	Yellow	Watchdog timer LED, flashing when WDT is active.
HDD	Red	Hard drive indicator, flashing when SATA drive is active.





## 2.2.6 GbE Port

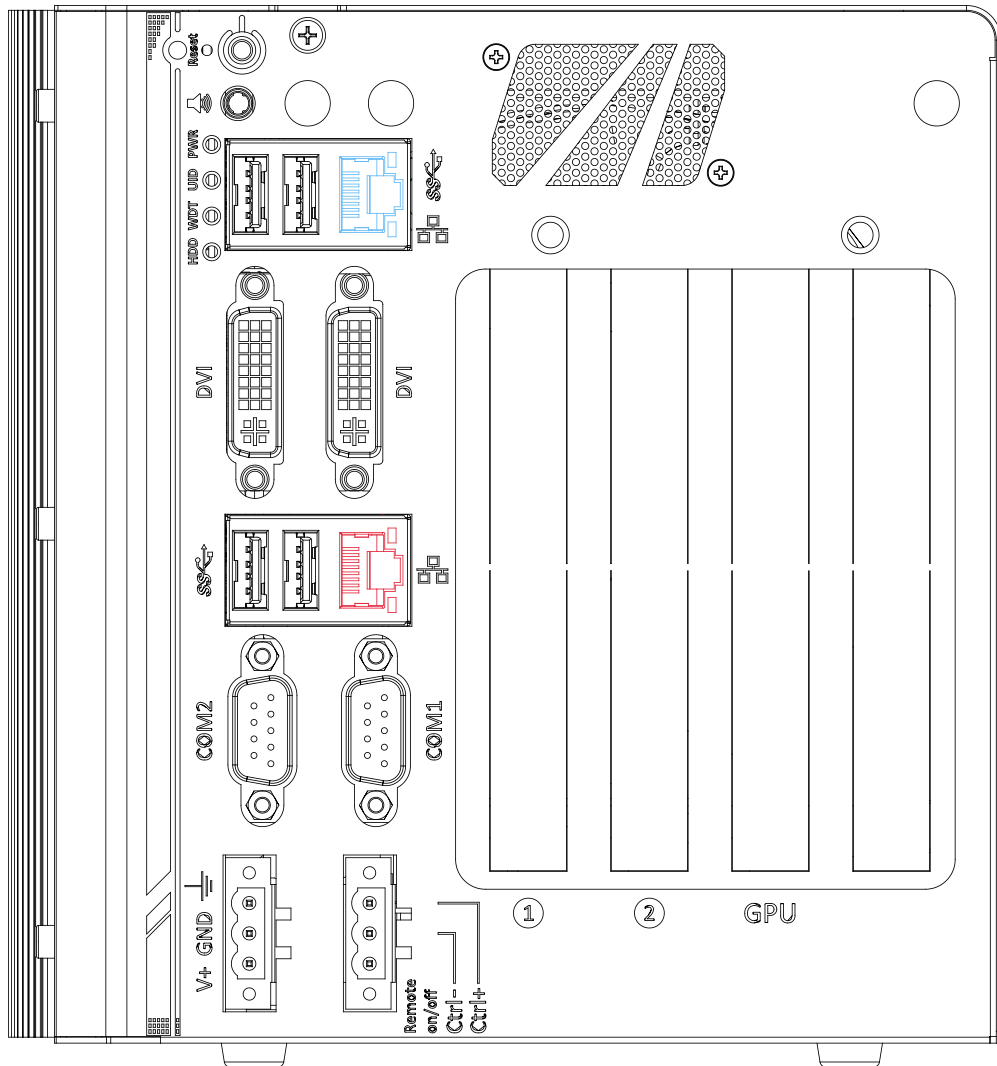

The system offers 2 GbE ports on its I/O panel. The GbE ports are marked in **blue/red** and are implemented with Intel® I219-LM/ Intel® I210-IT controllers, respectively. Each port has one dedicated PCI Express link for maximum performance. When an Ethernet connection is established, the LED indicators on the RJ45 connector represents the following connection statuses:

### Active/Link LED

LED Color	Status	Description
Green	Off	Ethernet port is disconnected
	On	Ethernet port is connected and no data transmission
	Flashing	Ethernet port is connected and data is transmitting/receiving

### Speed LED

LED Color	Status	Description
Green or Orange	Off	10 Mbps
	Green	100 Mbps
	Orange	1000 Mbps

The port implemented using Intel® I219-LM (in **blue**) supports Wake-on-LAN function. Drivers may be required to utilize the GbE port in Windows environment.

## 2.2.7 DVI Port

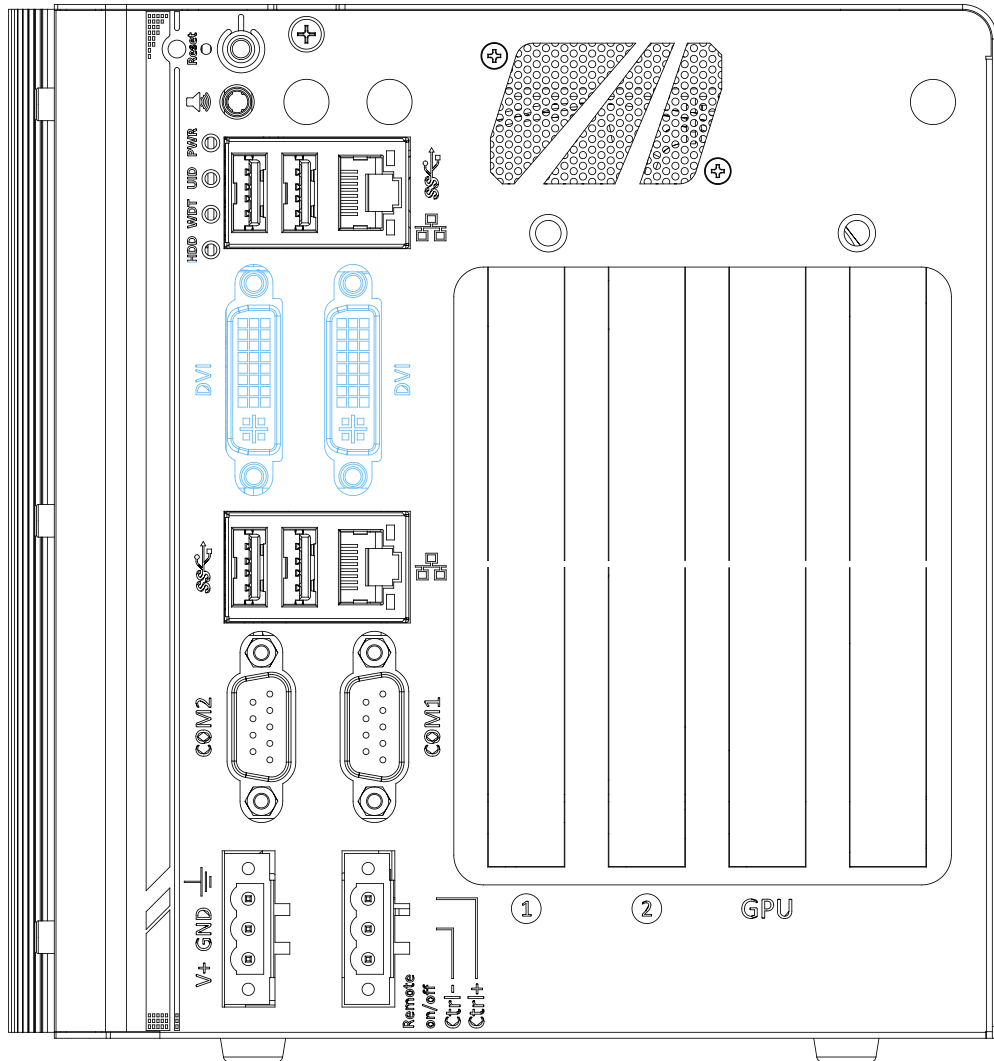

The system has two DVI connectors on its I/O panel to support dual independent display outputs. DVI transmits graphics data in digital format and therefore can deliver better image quality at high resolutions. For VGA monitor, Neousys offers a specialized DVI-to-VGA adaptor as an accessory shipped with the system. This adapter supports VGA DDC signals and thus eliminates compatibility issues with VGA monitors. The DVI connector can output DVI or other digital signals via an adaptor or dedicated cable up to 1920 x 1200 resolution.



**DVI to HDMI cable**



**DVI-VGA adaptor**

## 2.2.8 COM Port

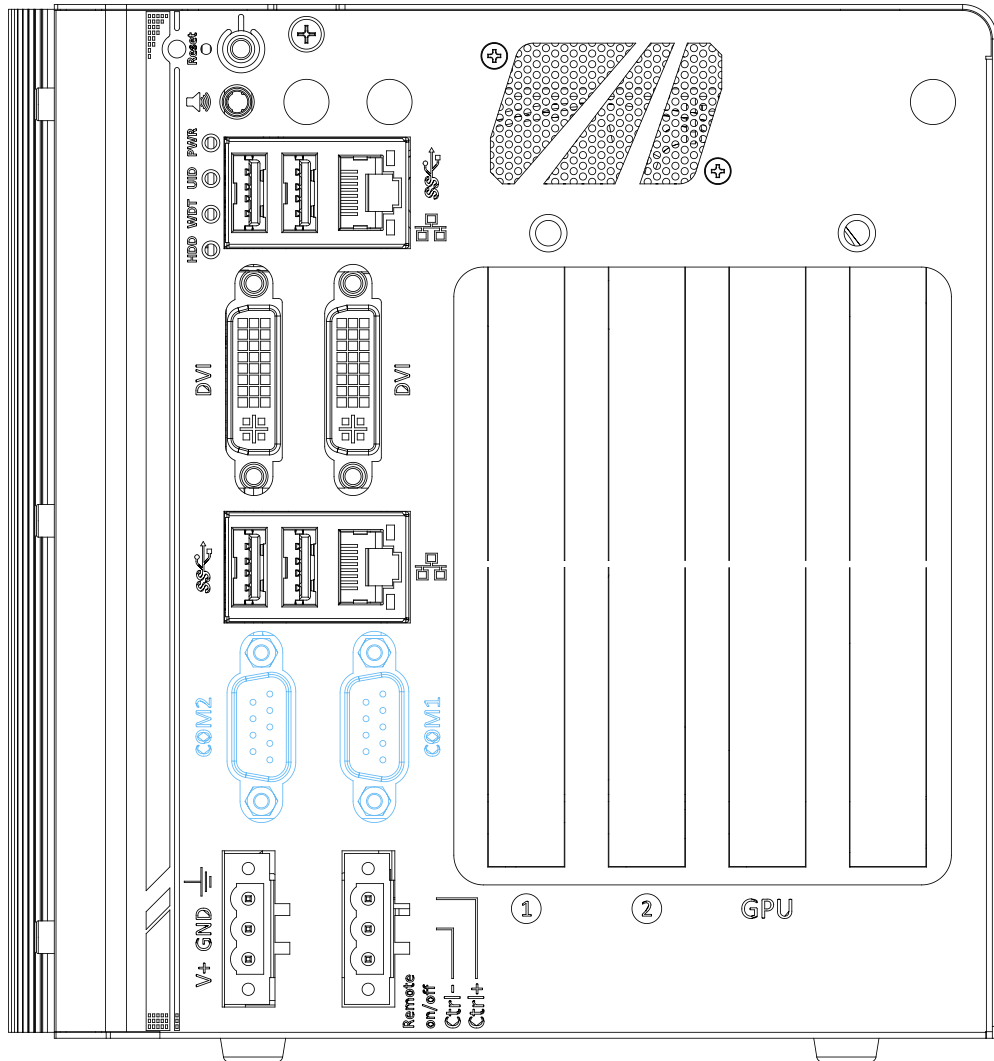

The system provides totally five COM ports for communicating with external devices. These COM ports are implemented using industrial-grade ITE8786 Super IO chip (-40 to 85°C) and provide up to 115200 bps baud rate.

COM1 and COM2 are software-selectable RS-232/422/485 ports. The operation mode of COM1 and COM2 can be set in BIOS setup utility. The following table describes the pin definition of COM ports.

### COM Port Pin Definition

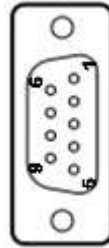

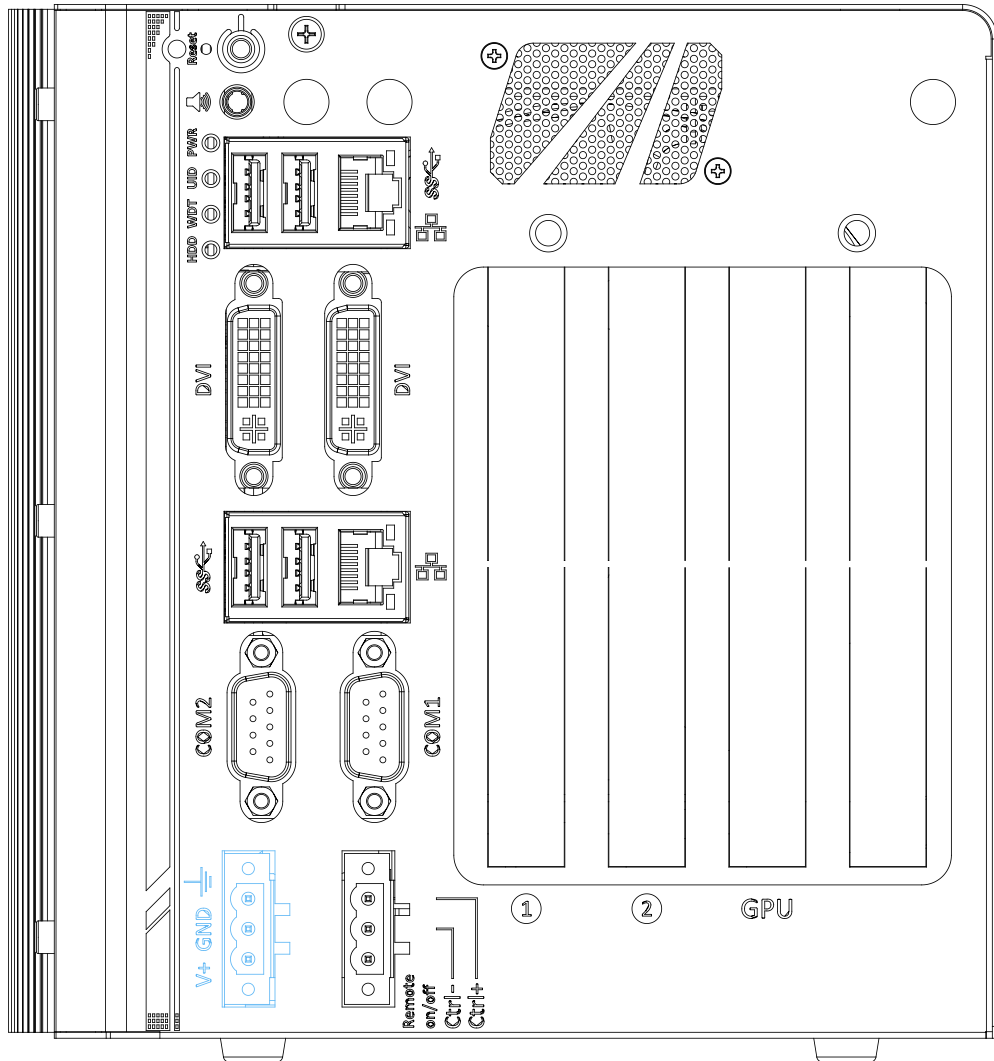

	COM1 & COM2		
Pin#	RS-232 Mode	RS-422 Mode	RS-485 Mode (Two-wire 485)
1	DCD		
2	RX	422 TXD+	485 TXD+/RXD+
3	TX	422 RXD+	
4	DTR	422 RXD-	
5	GND	GND	GND
6	DSR		
7	RTS		
8	CTS	422 TXD-	485 TXD-/RXD-
9	RI		

### 2.2.9 3-Pin Terminal Block for DC Input



The system accepts 24V DC power input via a 3-pin pluggable terminal block, which is fit for field-use where DC power is usually provided. The screw clamping mechanism on the terminal block offers connection reliability when wiring DC power.

Symbol	Description
	Chassis ground (connect to the earth ground)
GND	Negative polarity (ground) of DC input
V+	Positive polarity of DC input



**WARNING**

*Please make sure the voltage of DC power is correct before you connect it to the system. Supplying a voltage over 24V will damage the system.*

### 2.2.10 3-Pin Remote On/ Off

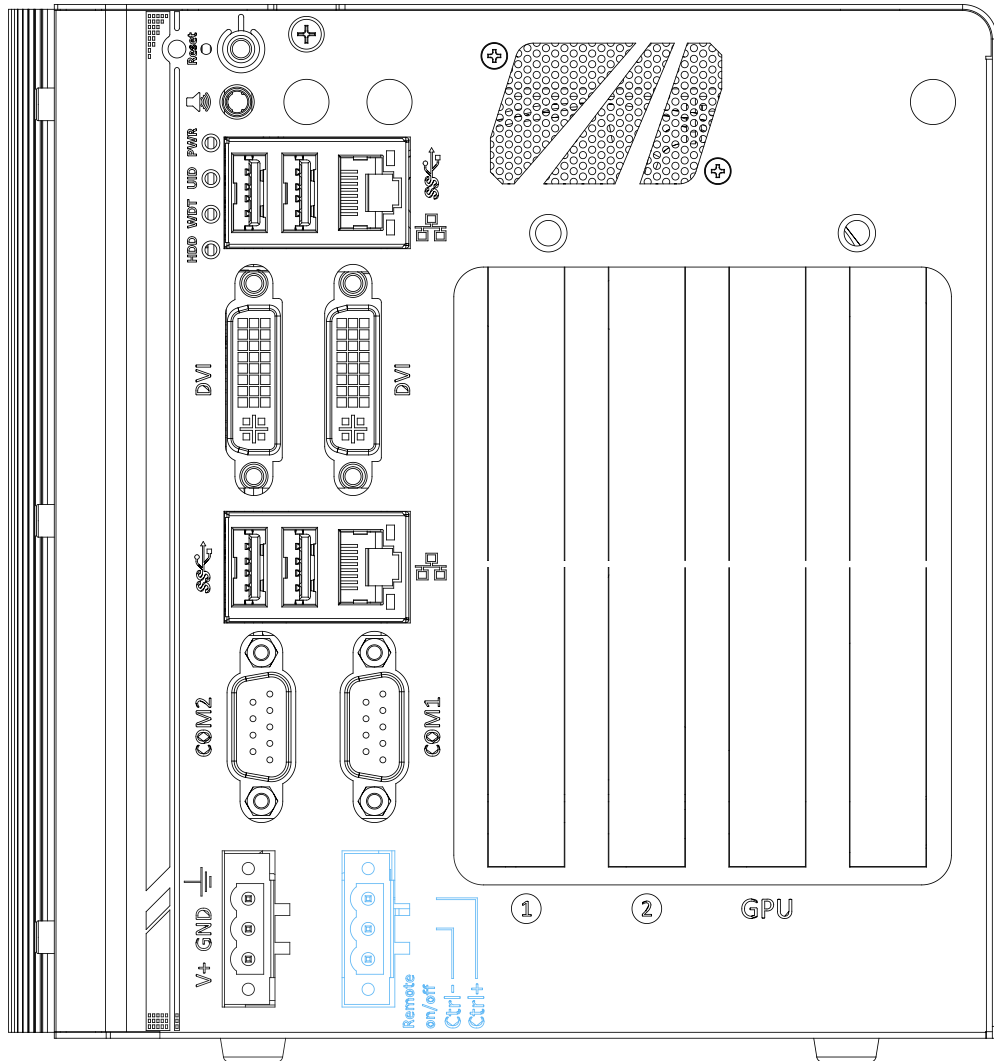

The “Remote On/ Off” 3-pin connection allows for external switch extension. It is useful when the system is placed in a cabinet or a not easily accessed location.

## 2.3 Internal I/O Functions

In addition to I/O connectors on the front panel, the system also provides internal on-board connectors, such as remote on/off control, LED status output, internal USB 2.0 ports, 12V power and etc. In this section, we'll illustrate these internal I/O functions.

### 2.3.1 Status LED Output & Remote On/ Off Control and Pin Definition



For an application which places the system inside a cabinet, it's useful to have an external system status LED indicators. The system provides a 2x6, 2.0mm pitch pin header to output system status such as power, HDD, watchdog timer, and control system on/ off remotely.

The status LED output has a built-in series-resistor and provides 10mA current to directly drive the external LED indicators. System on/ off control is also provided so you can use an external non-latched switch to turn on/ off the system exactly the same as the power button on the front panel. The following table describes the pin definition of the status LED output.

**Pin Definition**

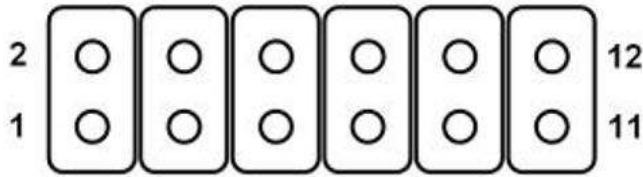

Pin#	Definition	Description
1	WDT_LED-	<b>[Output]</b> Watchdog timer indicator, flashing when watchdog timer is started.
2	WDT_LED+	
3	UID_LED-	<b>[Output]</b> User defined LED, reserved for future usage
4	UID_LED+	
5	HDD-	<b>[Output]</b> Hard drive indicator, flashing when SATA hard drive is active.
6	HDD+	
7	Power_LED-	<b>[Output]</b> System power indicator, on if system is turned on, off if system is turned off.
8	Power_LED+	
9	Ctrl-	<b>[Input]</b> Remote on/off control, connecting to an external switch to turn on/off the system. (polarity is negligible).
10	Ctrl+	
11	NA	Un-used pin
12	NA	

 **NOTE**

*Please make sure the polarity is correct when you connect the external LED indicator to the Status LED Output.*



### 2.3.2 Dual DRAM SODIMM Slot

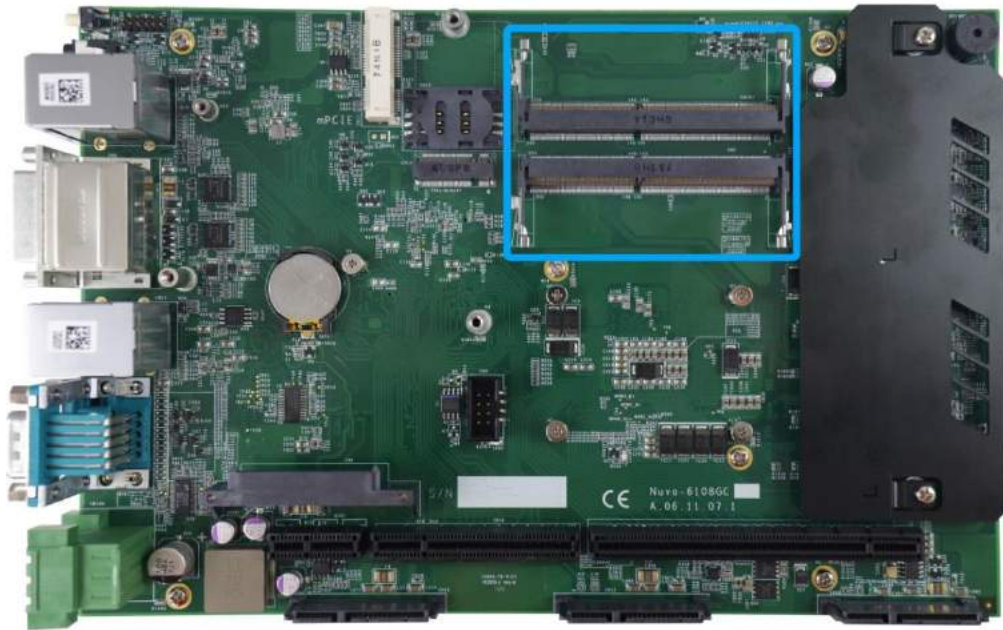

The system motherboard supports two 260-pin SODIMM socket for installing DDR4 memory module up to 32GB. Each slot supports single module DDR4 2133MHz SODIMM up to 16GB capacity.

### 2.3.3 mini-PCIe Slot and Pin Definition

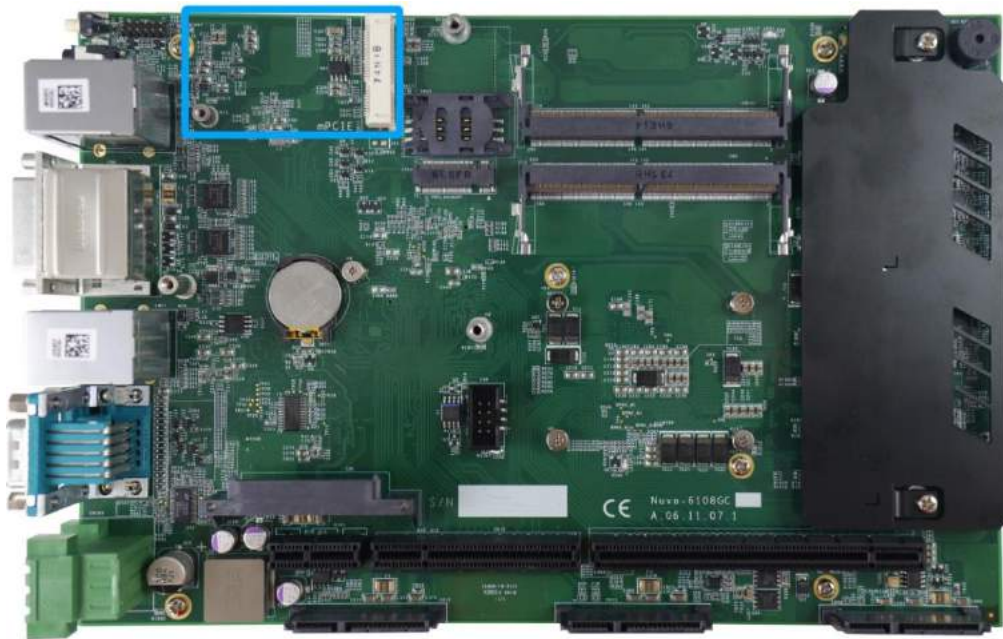

The system has a mini-PCIe slot to accommodate solid-state storage device (SSD) or wireless LAN module. Using SSD offers extreme reliability for harsh environments with intense vibration/shock. The system recognizes mini-PCIe SSD as a native storage device so you may install any operating system on the mini-PCIe SSD module, such as Windows 7, Windows 8, Windows 10, Linux and etc.

For wireless 3G/ 4G communication, SMA antenna apertures can be located on the I/O panel, next to the speaker jack.

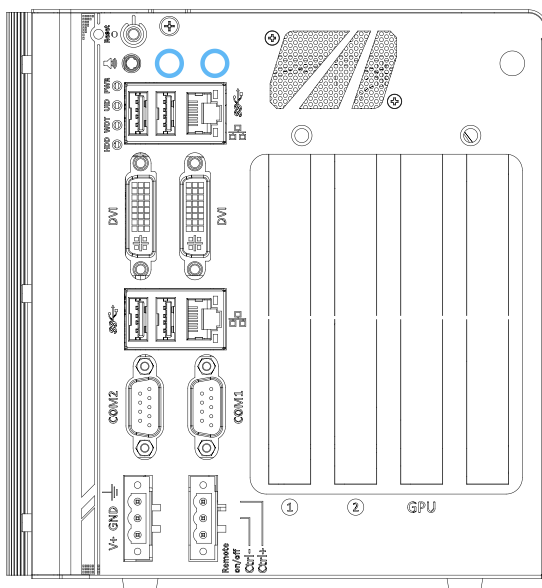

**Pin Definition**

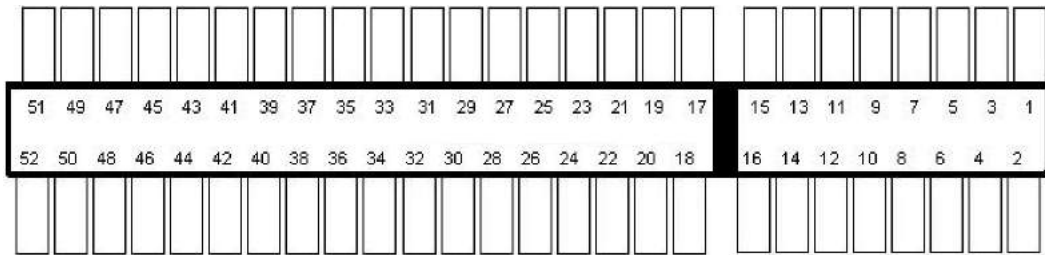

Pin #	Signal	Pin #	Signal
1	WAKE#	2	+3.3Vaux
3	COEX1	4	GND
5	COEX2	6	+1.5V
7	CLKREQ#	8	UIM_PWR
9	GND	10	UIM_DATA
11	REFCLK-	12	UIM_CLK
13	REFCLK+	14	UIM_RESET
15	GND	16	UIM_VPP
<b>Mechanical Key</b>			
17	Reserved* (UIM_C8)	18	GND
19	Reserved* (UIM_C4)	20	W_DISABLE#
21	GND	22	PERST#
23	PERn0	24	+3.3Vaux
25	PERp0	26	GND
27	GND	28	+1.5V
29	GND	30	SMB_CLK
31	PETn0	32	SMB_DATA
33	PETp0	34	GND
35	GND	36	USB_D-
37	GND	38	USB_D+
39	+3.3Vaux	40	GND
41	+3.3Vaux	42	LED_WWAN#
43	GND	44	LED_WLAN#
45	Reserved	46	LED_WPAN#
47	Reserved	48	+1.5V
49	Reserved	50	GND
51	Reserved	52	+3.3Vaux



**WARNING**

*Some off-the-shelf mini-PCIe 4G modules are not compliant to standard mini-PCIe interface. They use 1.8V I/O signals instead of standard 3.3V I/O and may have signal conflict. Please consult with Neousys for compatibility when in doubt! Installing an incompatible 4G module may damage the system or the module itself may be damaged.*

### 2.3.4 M.2 (B Key) and SIM Card Slot

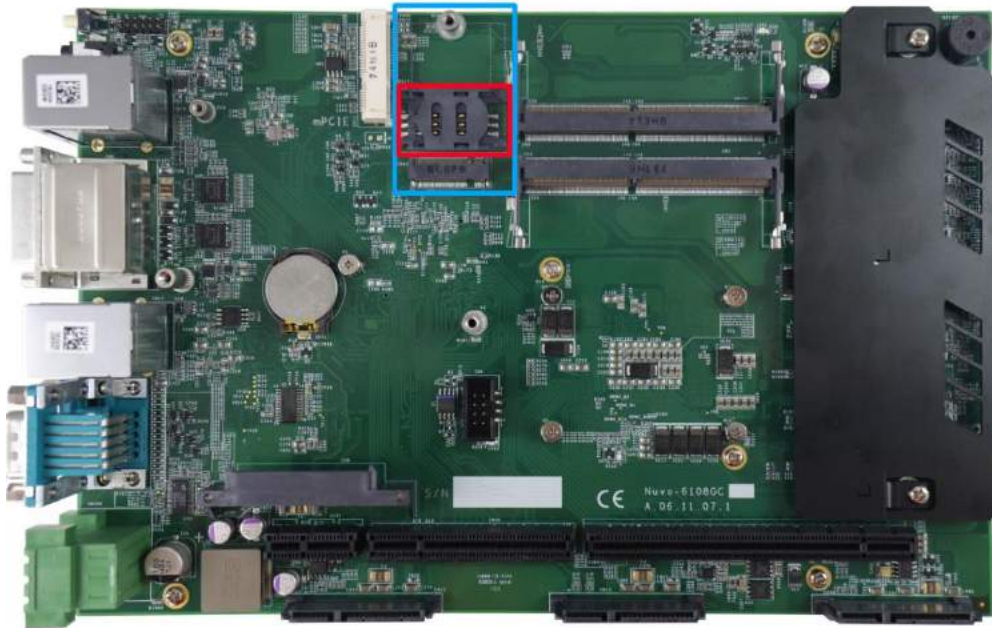

The system has a M.2 (indicated in **blue**) slot that works in cooperation with a SIM slot (indicated in **red**). By installing a M.2 module, you can install a 3G/ 4G module with a SIM card for internet access via your service provider’s 3G/ 4G network.

For wireless 3G/ 4G communication, SMA antenna apertures can be located on the I/O panel, next to the speaker jack.

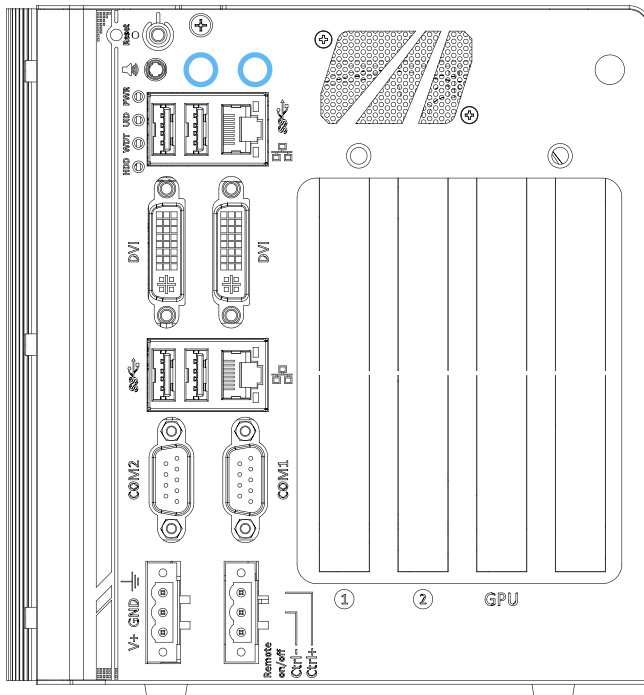

**M.2 Slot Pin Definition**

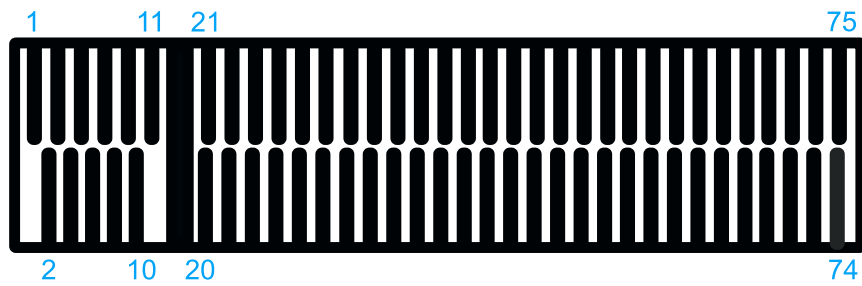

Pin #	Signal	Pin #	Signal
1	-	2	P3V3
3	GND	4	P3V3
5	GND	6	-
7	USB_D+	8	-
9	USB_D-	10	-
11	GND	12	KEY
13	KEY	14	
15		16	
17		18	
19		20	-
21	-	22	-
23	-	24	-
25	-	26	-
27	GND	28	-
29	-	30	UIM_RST
31	-	32	UIM_CLK
33	GND	34	UIM_DATA
35	-	36	UIM_PWR
37	-	38	-
39	GND	40	-
41	-	42	-
43	-	44	-
45	GND	46	-
47	-	48	-
49	-	50	PLTRST
51	GND	52	-
53	-	54	-
55	-	56	-
57	GND	58	-
59	-	60	-
61	-	62	-
63	-	64	-
65	-	66	-
67	PLTRST	68	-
69	-	70	P3V3
71	GND	72	P3V3
73	GND	74	P3V3
75	-		

### 2.3.5 SATA Port 1

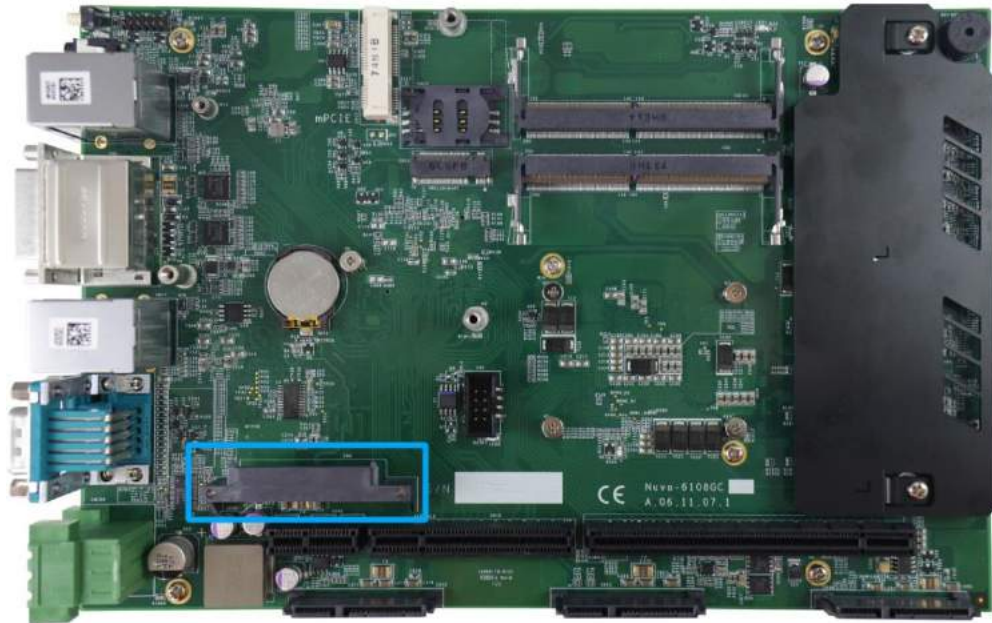

The system features four SATA ports. SATA port No. 1 located near the center of the motherboard via a 22-pin SATA connector. You can directly mount a 2.5" HDD/SSD to this port using the bracket that came with the system. For installing procedures, please refer to "[Installing HDD/ SSD to SATA Port 1](#)".

### 2.3.6 SATA Ports 2, 3 and 4



The system has a total of four SATA ports. In addition to SATA port No. 1 mentioned in the previous section, from left to right, SATA port No. 2, 3 and 4 are located at the bottom of the motherboard via 22-pin SATA connectors. The hard drive/ SSD must be secured onto the hard drive tray that came with the system. For installation procedures, please refer to [Installing HDD/ SSD to SATA Ports 2/ 3/ 4](#).

### 2.3.7 Internal USB Port on Extension Board



The system's daughter board has an internal USB2.0 port on the PCBA. You can utilize this USB port to connect a USB protection dongle inside the chassis of the system.



### 2.3.8 PCIe 8-Pin and 6-Pin 12V VDC Power Connector



For high performance graphics cards, an additional 12V input is required. The system offers an 8-pin and a 6-pin PCIe power connector on its daughter board. It supports a PCI Express graphics card with up to 250W TDP.

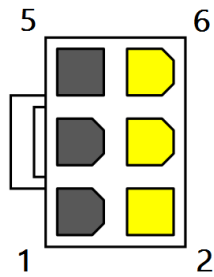

Pin#	Pin Definition
1	GND
2	12 VDC
3	GND
4	12 VDC
5	GND
6	12 VDC

### 2.3.9 X16/ x8 PCI Express Slots

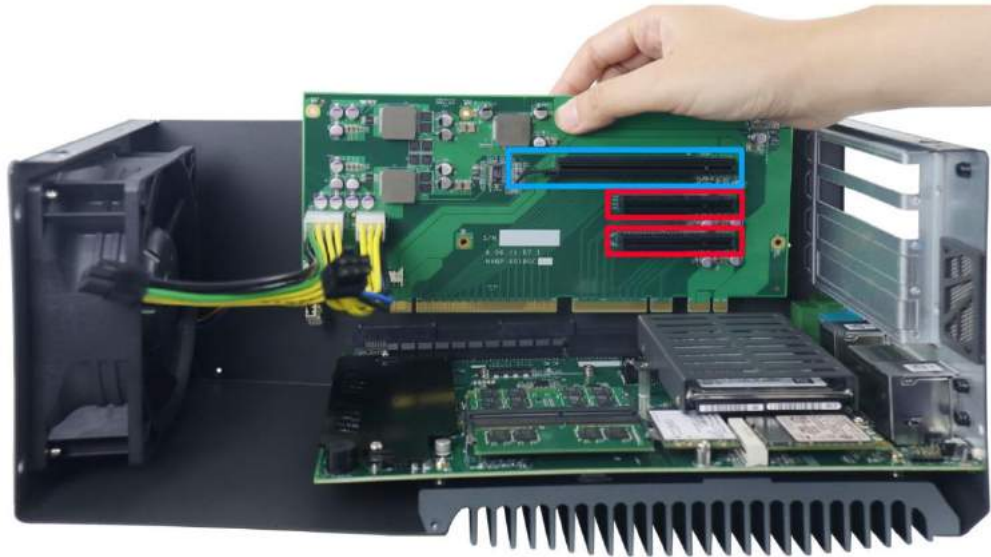

The system has two x8 (indicated in **red**) and one x16 (indicated in **blue**) PCI Express slot. The x8 slot is running at Gen3, 4-lanes PCIe signals and can deliver up to 7.9GB/s bandwidth. The x16 slot is running at Gen3, offering 16-lanes PCIe signals and can deliver up to 15.8GB/s bandwidth. The x16 PCIe slot is suitable for both graphics card and I/O card installation.



#### NOTE

*The power consumption of the installed PCIe graphics card should be confined to **250W** to limit the heat generated by add-on cards and maintain system stability.*

### 3 System Installation

Before disassembling the system enclosure and installing components and modules, please make sure you have done the following:

- It is recommended that only qualified service personnel should install and service this product to avoid injury or damage to the system.
- Please observe all ESD procedures at all times to avoid damaging the equipment.
- Before disassembling your system, please make sure the system has powered off, all cables and antennae (power, video, data, etc.) are disconnected.
- Place the system on a flat and sturdy surface (remove from mounts or out of server cabinets) before proceeding with the installation/ replacement procedure.

### 3.1 Disassembling the System

To access system internal components, the system needs to be disassembled. To disassemble the system enclosure, you need to remove screws on the I/O panel, removable side panel and system ventilation panel.

1. On the I/O panel side, unscrew the screw shown below.

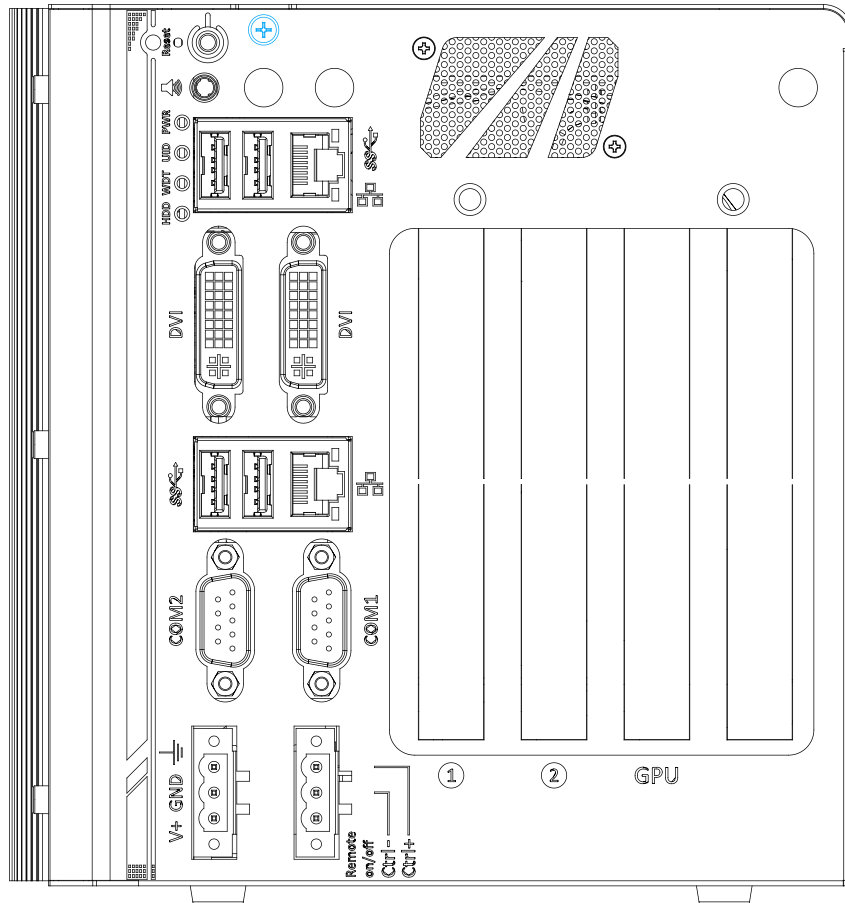

2. Unscrew the screw shown on top of the enclosure.

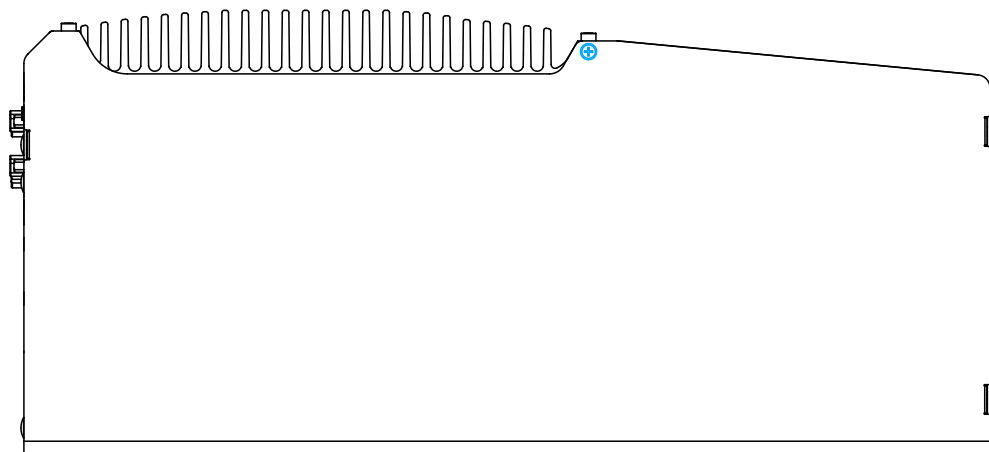

3. Unscrew the five screws on the removable side panel shown below.

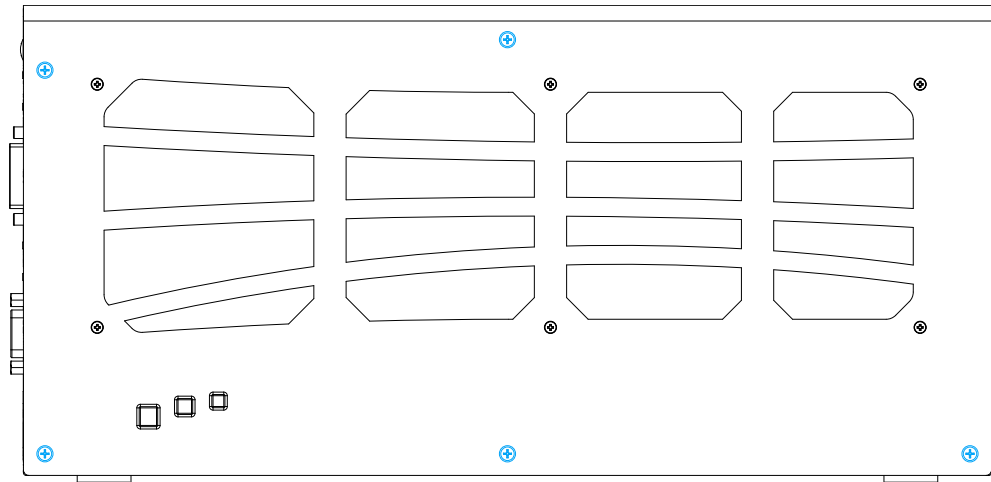

4. Unscrew the two screws on the system ventilation fan panel shown below.

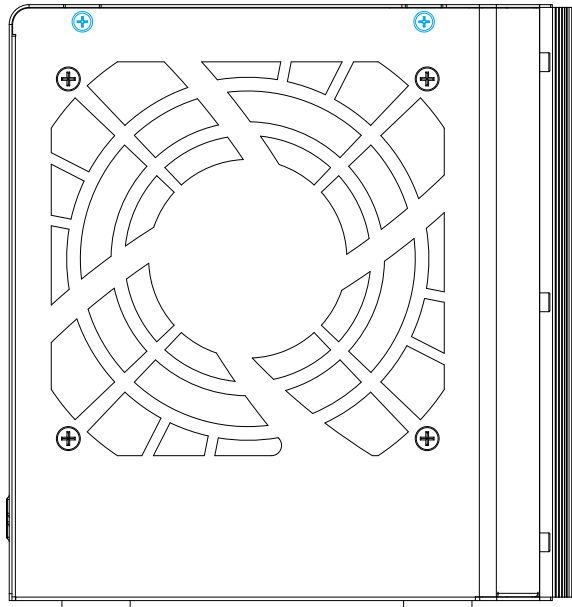

5. Due to the clip on mechanism (indicated in blue), to remove the side panel, you need to gently slide it upwards and then pull outwards to remove the side panel.



**Slide upwards**

**Pull outwards**

6. Remove the graphics card support frame by unscrewing the four screws shown and slide upwards to remove the support frame.

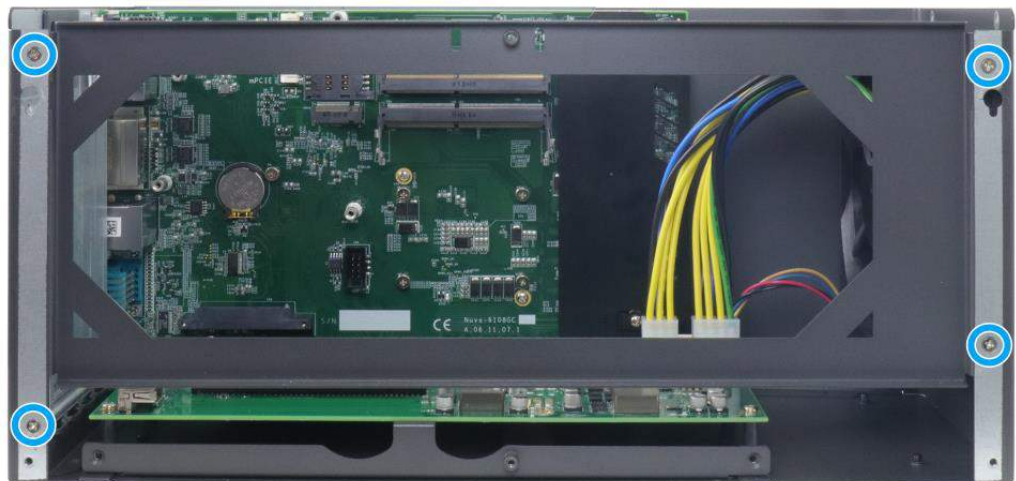

7. To remove the daughter board, unscrew the four screws shown.



8. Gently disengage the daughter board from the motherboard and out of the enclosure.

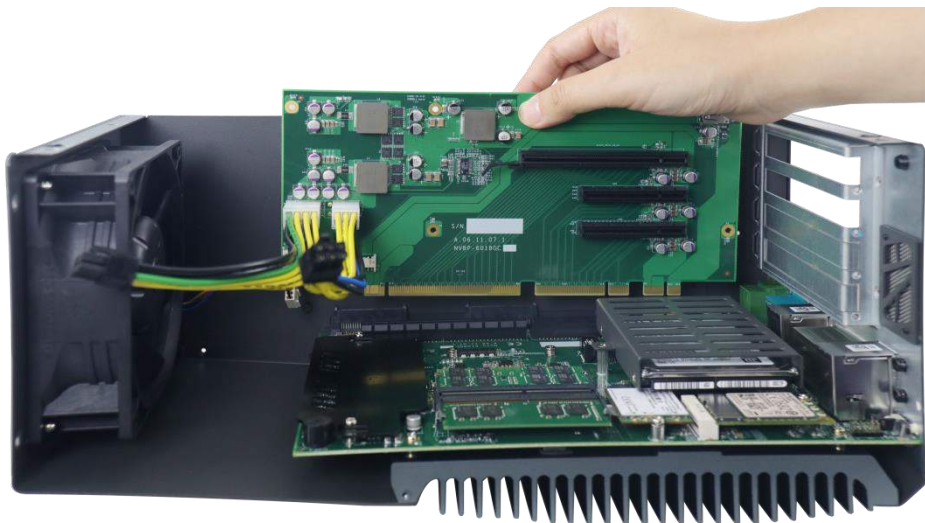

9. On the side of enclosure, unscrew the six screws.



10. Gently lift the heatsink and motherboard upwards to separate it from the enclosure.
11. Remove the 2.5" hard drive bracket by unscrewing the two screws.

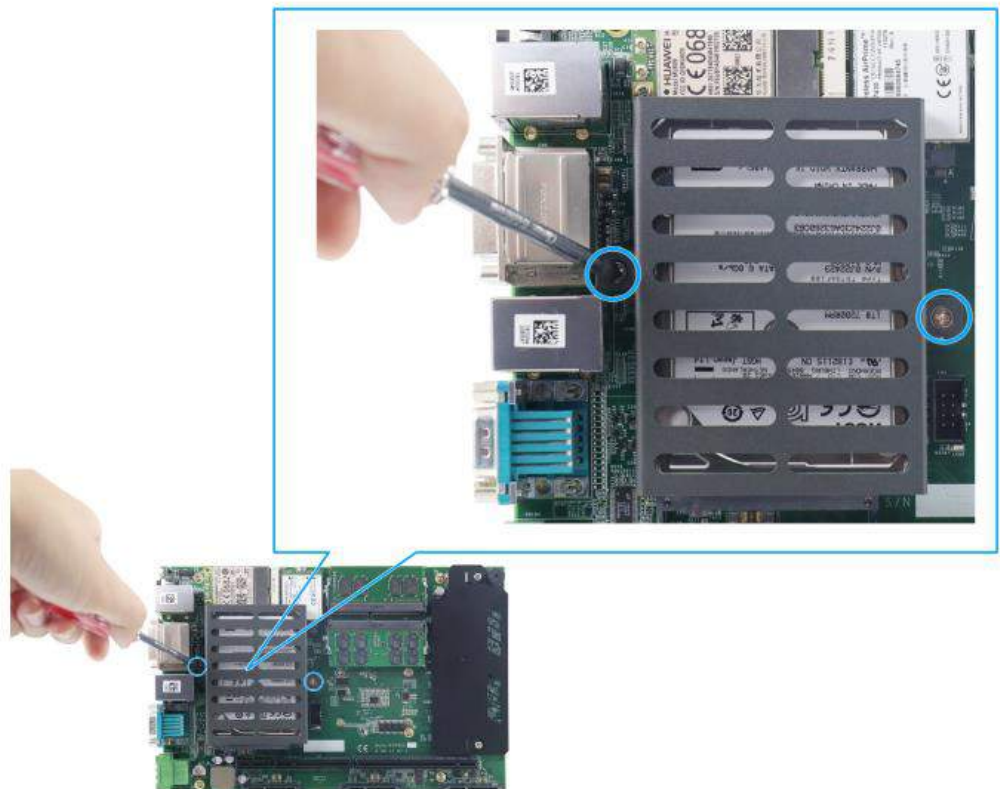



12. Separate the motherboard from the heatsink by removing the nine screws shown below.

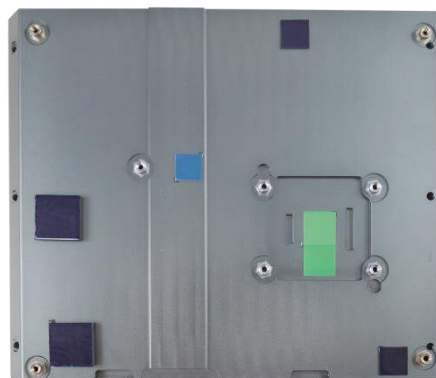
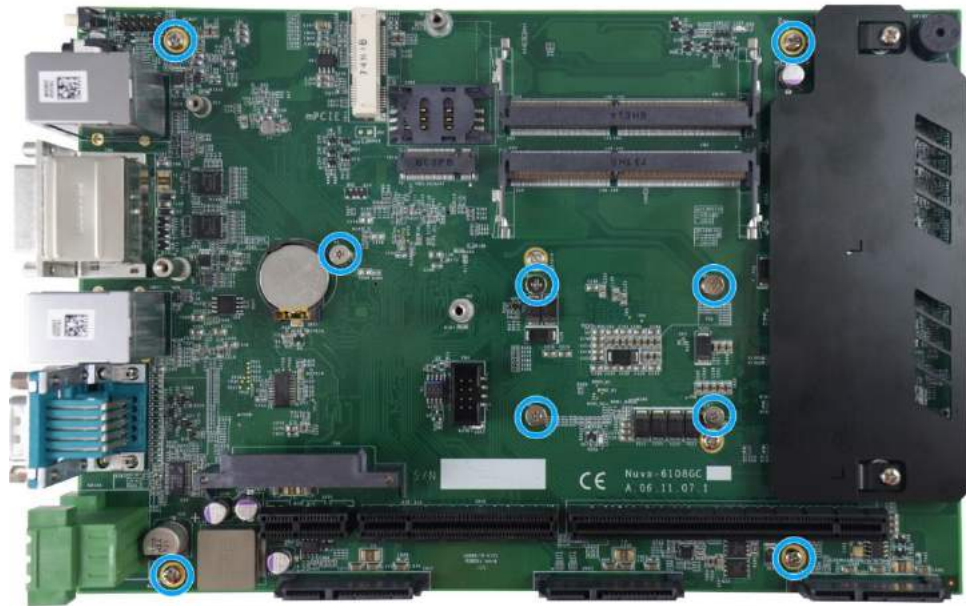

**Heatsink**



**Motherboard**

## 3.2 Installing Internal Components

### 3.2.1 CPU Installation Procedure

1. Between the motherboard and the heatsink, you'll see the CPU socket protective cover, place finger tips underneath the sign "REMOVE" for leverage and gently lift the cover.



#### **WARNING**

*With the protective cover removed, please be careful when handling the motherboard. DO NOT touch the pins in the LGA socket!*

2. Remove the CPU from its container/ tray. Match the two notches on the side to the protrusions in the socket, gently lower the CPU into the socket.



3. Locate the CPU retention bracket from the accessory box. Place the retention bracket on the CPU and hold it in place.



4. Turn the motherboard around and secure the bracket by tightening two M3 P-head screws.

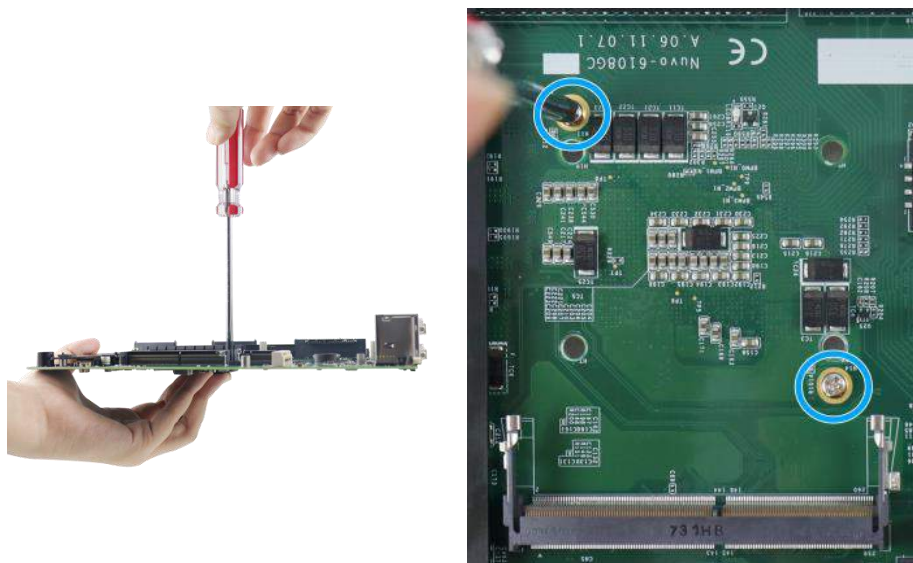

**Hold CPU bracket firmly and turn the motherboard around**

**Secure two M3 P-head screws**

5. Remove all thermal pads' protective films on the heatsink.

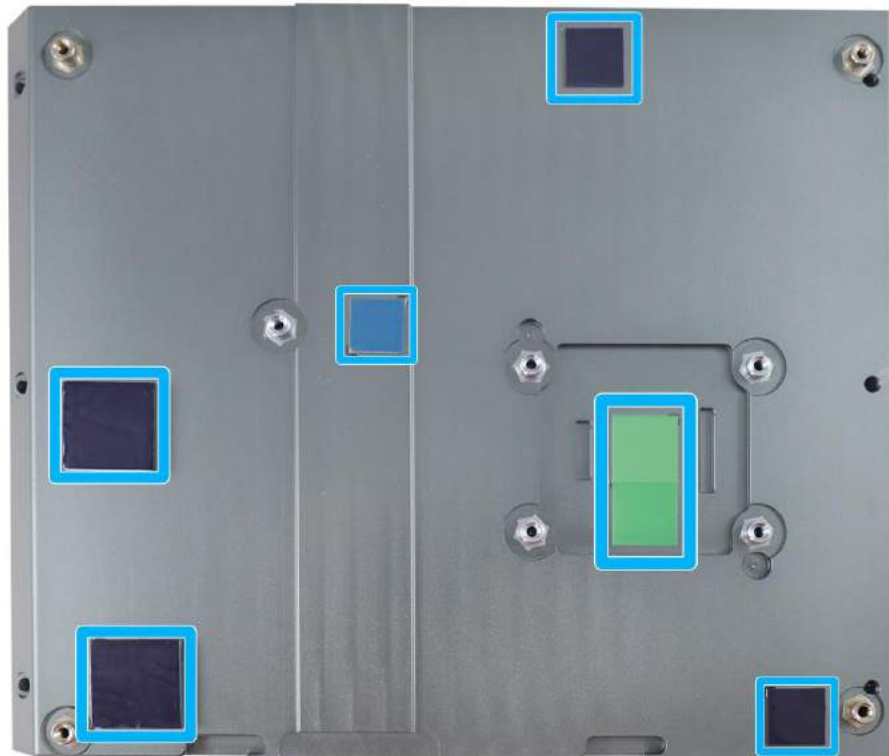

6. With the five motherboard standoffs aligned, gently lower the motherboard onto the heatsink.

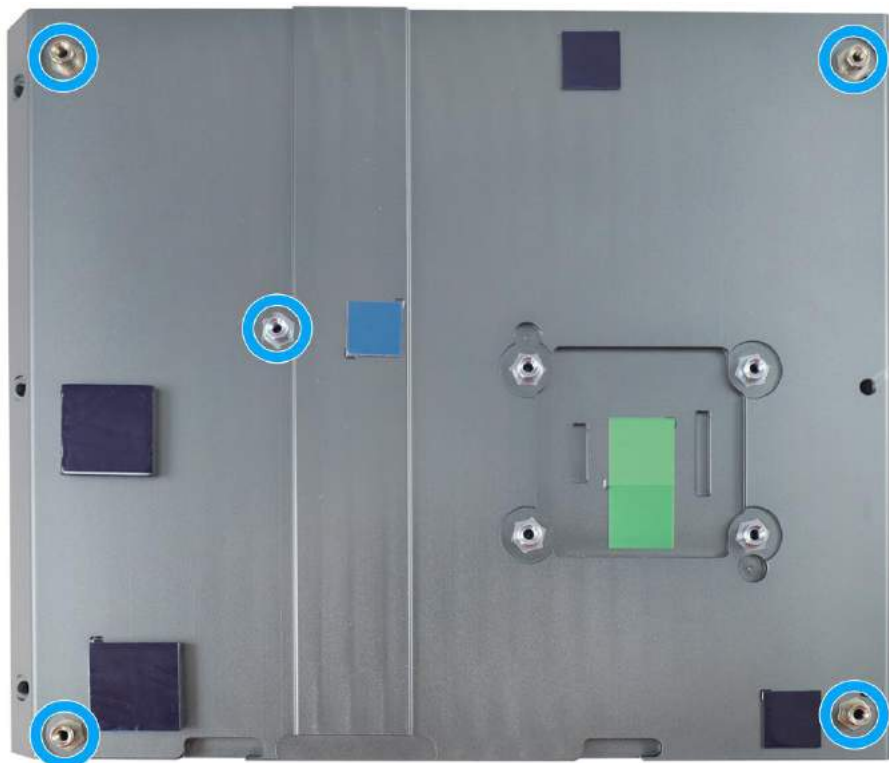

7. Once the motherboard has been installed, you're ready to secure the five screws that help the heatsink apply pressure to the CPU/ chipset die. You'll want to apply even pressure to the corners by gradually tightening each screw.

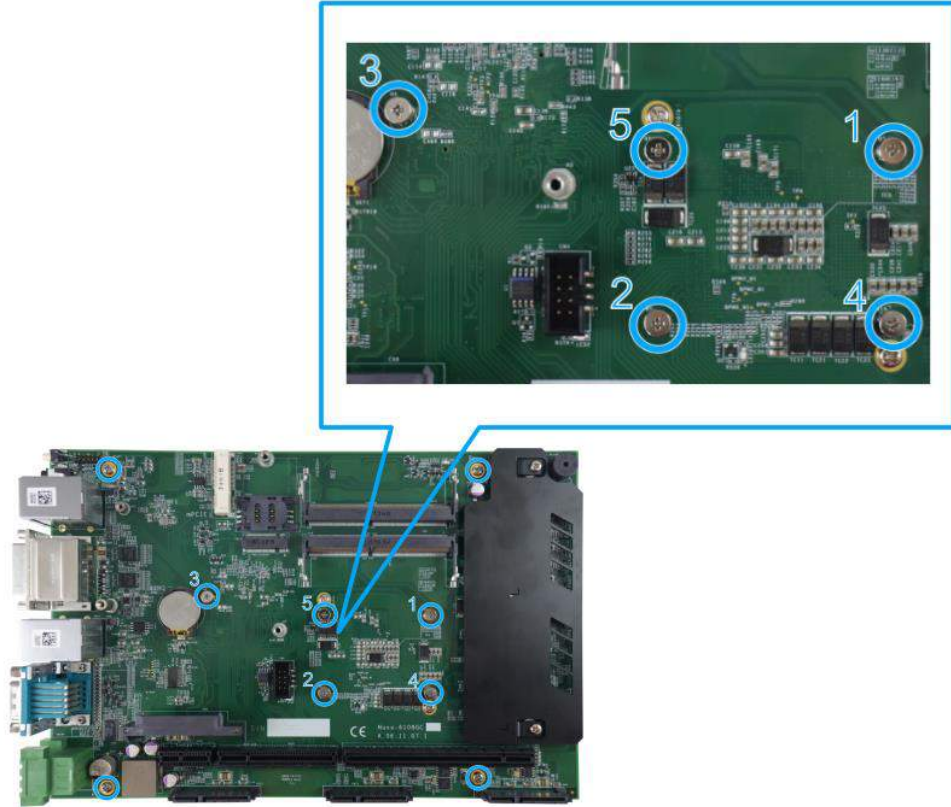

8. [Reinstall the system enclosure](#), daughter board and panel when done.
9. If you need to install other components, please refer to respective sections.

### 3.2.2 DDR4 SO-DIMM Installation

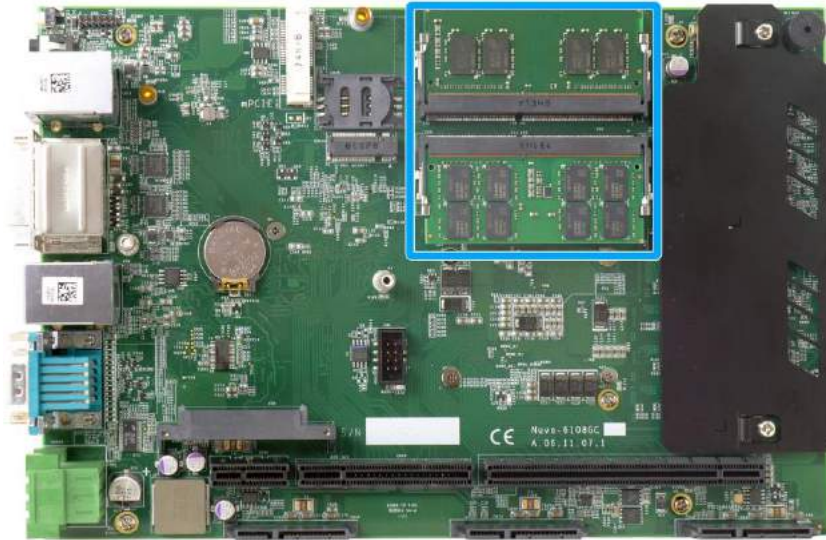

There are two memory SO-DIMM slots on the motherboard that support a total maximum of 32GB DDR4-2133. Please follow the procedures below to replace or install the memory modules.

1. Please refer to the section “[Disassembling the System](#)”, you may not need to completely dismantle the system to gain access to the memory module slots.
2. Locate the [SODIMM memory module slots](#) on the motherboard.
3. To install the memory module, insert gold fingers of the module into the slot at 45 degree angle, push down on the edge of the module and the clips on the side should clip the module into position.

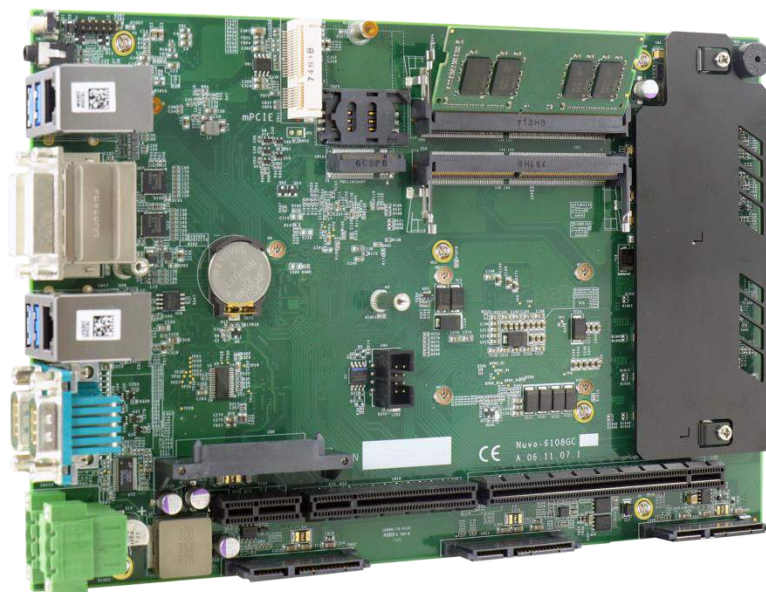

4. Push the memory module down until it is clipped-in.



5. Repeat steps 3 and 4 to install the other module.
6. [Reinstall the system enclosure](#) and panel when done.
7. If you need to install other components, please refer to respective sections.

### 3.2.3 M.2 Module, SIM Card and Antennae Installation

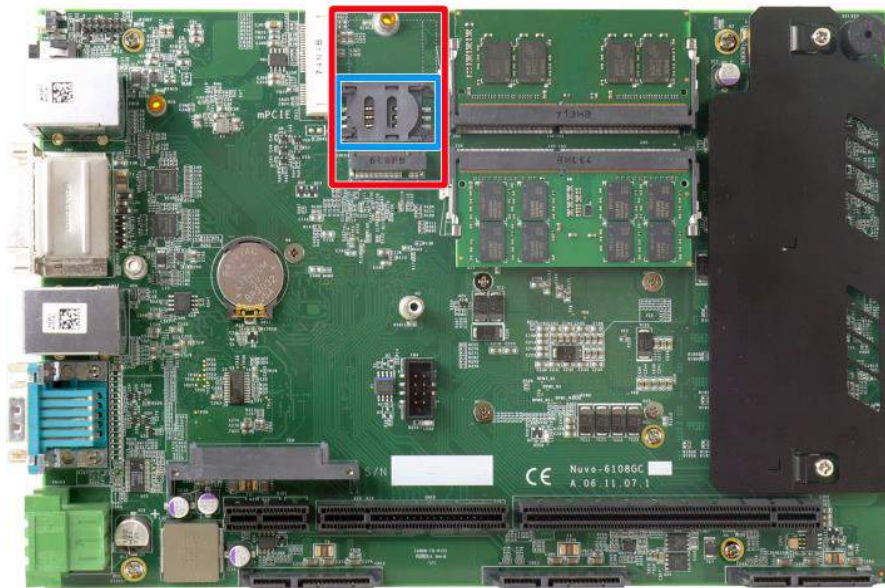

The system has a M.2 slot (indicated in red) coupled with SIM socket (indicated in blue) for installing 3G/ 4G module. For installation, please refer to the following instructions.

1. Please refer to the section “[Disassembling the System](#)”, you may not need to completely dismantle the system to gain access to the M.2 slot and SIM socket.
2. Before installing the M.2 module, you need to insert the SIM card. Slide the SIM slot towards the right and lift the SIM card holder. Insert the SIM card (pins facing up), shut the SIM holder and slide it towards the left to lock the SIM card in-place.

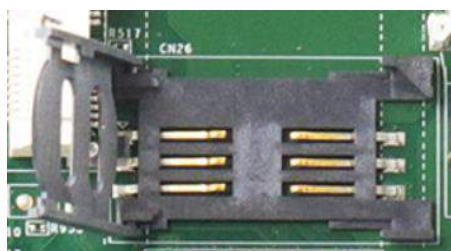

**Slide right and lift SIM card holder**



**Insert SIM card with pins facing up**

3. Secure the SIM card by sliding the holder to the right.





4. Insert the M.2 module on a 45 degree angle into the M.2 slot and secure the module.



**Insert on 45 degree angle**



**Secure the module**

5. Clip on the IPEZ-to-SMA cable to the module and secure the antenna to the rear panel. Please refer to the module's manual for clip-on connection.



**Clip on IPEZ-to-SMA cable**



**Secure antenna to rear panel**

6. [Reinstall the system enclosure](#) and panel when done.
7. If you need to install other components, please refer to respective sections.

### 3.2.4 mini-PCIe Module and Antennae Installation

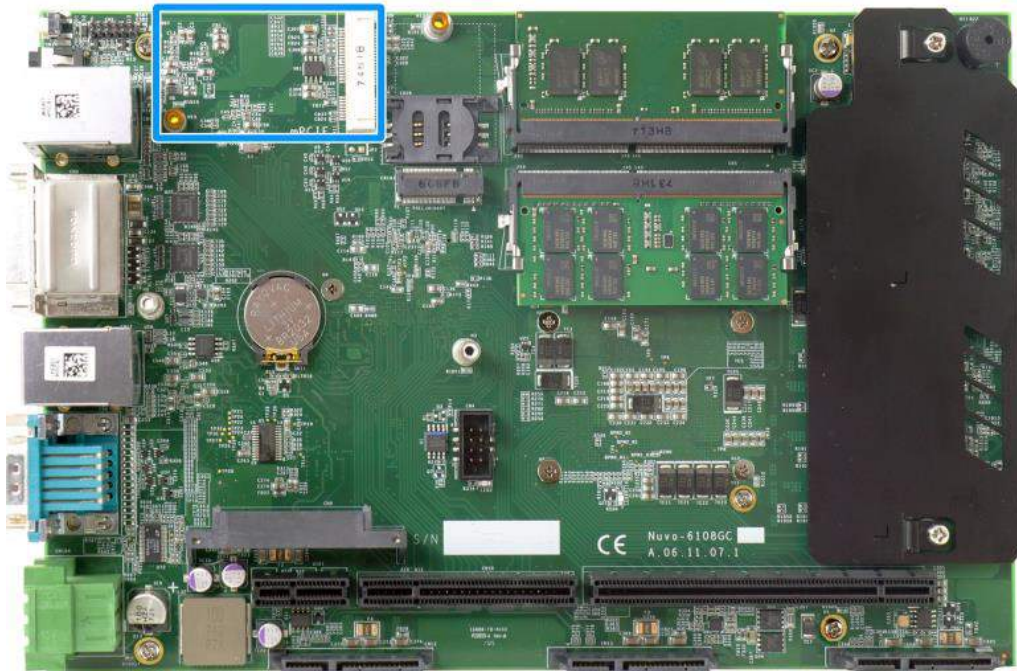

The system has a mini-PCIe slot (indicated in **blue**) for installing WiFi module. For installation, please refer to the following instructions.

1. Please refer to the section "[Disassembling the System](#)", you may not need to completely dismantle the system to gain access to the mini-PCIe slot.
2. Insert the module on a 45 degree angle.

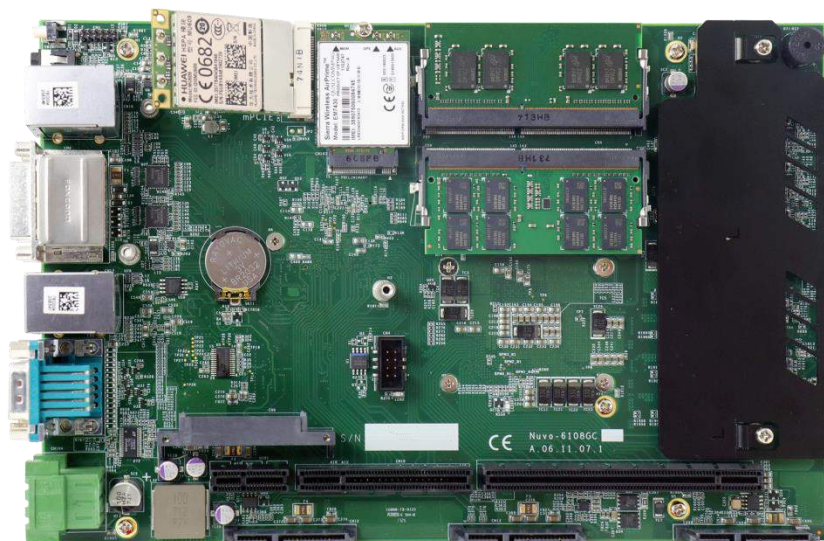

3. Gently press down and secure the module with an M2.5 P-head screw.



4. Clip on the IPEZ-to-SMA cable to the module and secure the antenna to the rear panel. Please refer to the module's manual for clip-on connection.

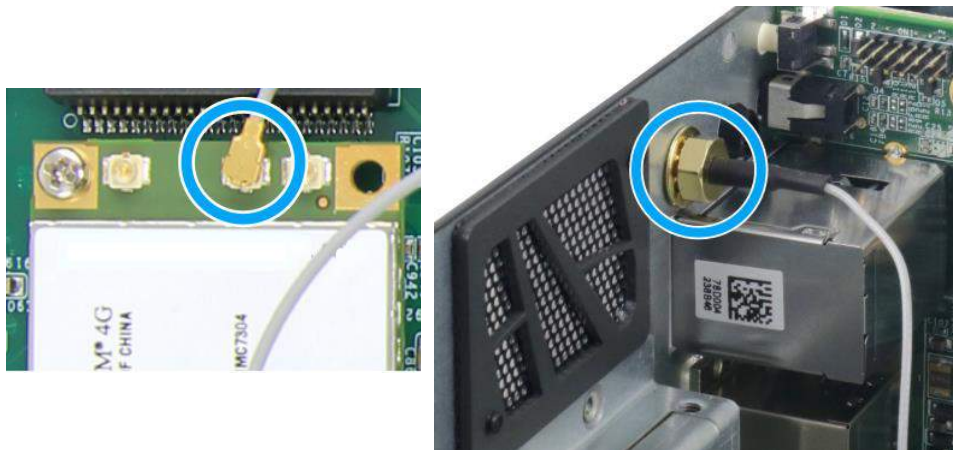

**Clip on IPEZ-to-SMA cable**

**Secure antenna to rear panel**

5. [Reinstall the system enclosure](#) and panel when done.
6. If you need to install other components, please refer to respective sections.

### 3.2.5 Installing HDD/ SSD to SATA Port 1

The system has four SATA ports. SATA port 1 indicated in **blue** requires a bracket to install the HDD/ SSD. The SATA ports 2/ 3/ 4 indicated in **red** require the HDDs/ SSDs to be installed on a tray. Please refer to the following instructions on how to install 2.5" SATA HDD/SSD to your system.

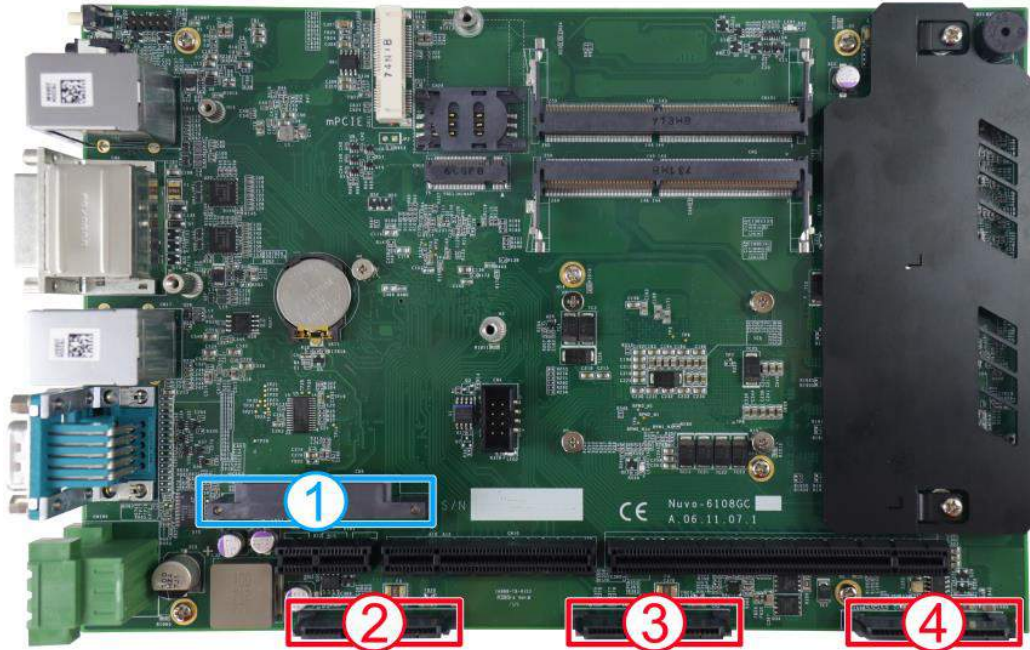

1. Please refer to the section "[Disassembling the System](#)" to gain access to SATA port 1.
2. The bracket for SATA port 1 can be found in the accessory box. To install, you must first secure the HDD/ SSD onto the bracket. Please note when secured, the HDD/ SSD should not protrude out of the bracket and the label of the HDD/ SSD should face inward.



3. Gently insert the SATA port of HDD/ SSD to SATA port 1, the two screw hole should meet the standoffs on the motherboard, screw using two M3 P-head screws.

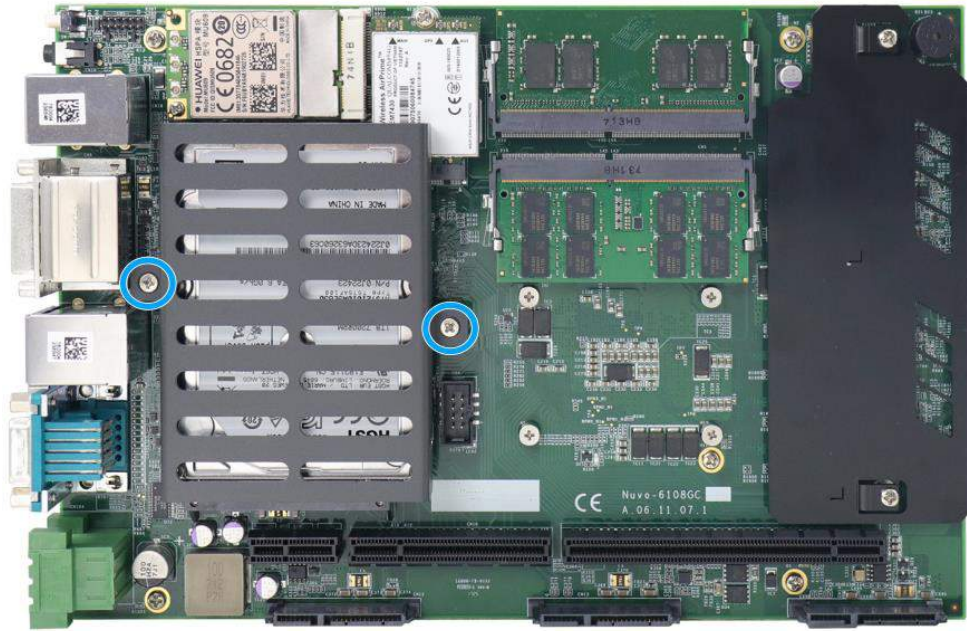

4. [Reinstall the system enclosure](#) and panel when done.
5. If you need to install other components, please refer to respective sections.

### 3.2.6 Installing HDD/ SSD to SATA Ports 2/ 3/ 4

The system has four SATA ports. SATA port 1 indicated in **blue** requires a bracket to install the HDD/ SSD. The SATA ports 2/ 3/ 4 indicated in **red** require the HDDs/ SSDs to be installed on a tray. Please refer to the following instructions on how to install 2.5" SATA HDD/SSD to your system.

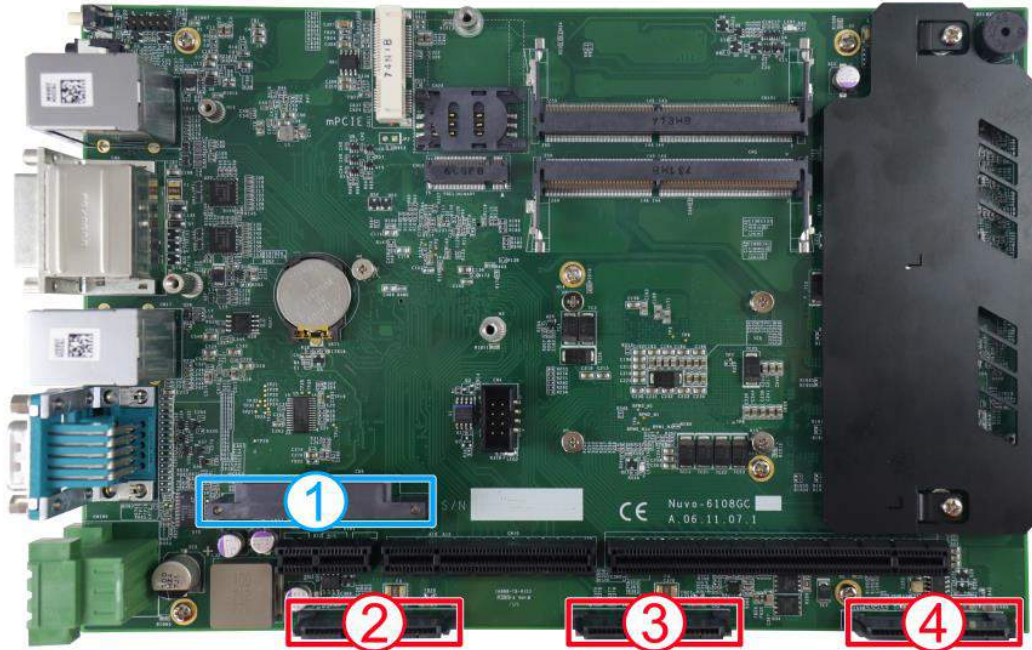

1. Please refer to the section "[Disassembling the System](#)", you may not need to completely dismantle the system to gain access to the SATA ports 2/ 3/ 4 and the HDD/ SSD tray.
2. To install HDD/ SSD to SATA ports 2/ 3/ 4, you must remove the tray out from underneath the daughterboard by unscrewing the two screws shown in the illustration below.



3. Align the HDD/ SSD to the preset screw holes (4 per drive) and secure the drives onto the tray using flathead screws.



**Use flathead screws to secure drive(s) Drive(s) secured on the tray**

4. Gently reinsert the tray back underneath the daughterboard while making sure the clips on both sides of the tray that holds the tray in-place. Secure the tray by screwing on the flathead screws removed in step 1.

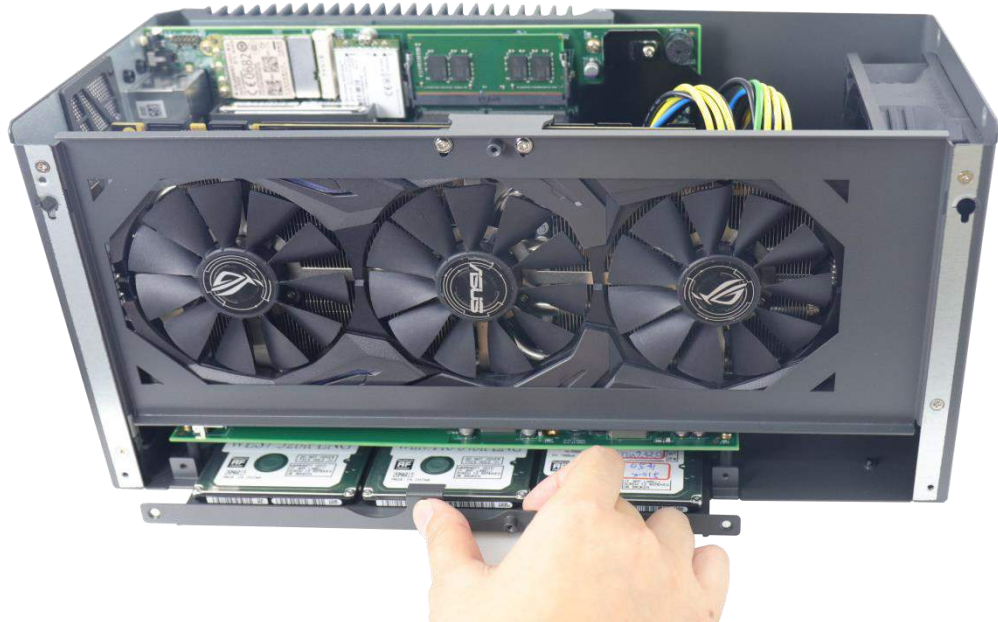

5. [Reinstall the system enclosure](#) and panel when done.
6. If you need to install other components, please refer to respective sections.

### 3.2.7 PCI/ PCIe Add-on Card Installation

The system provides two 8x PCI (indicated in **blue**) and one 16x PCIe (indicated in **red**) slots on the daughterboard. Please refer the following instructions on installing add-on cards.

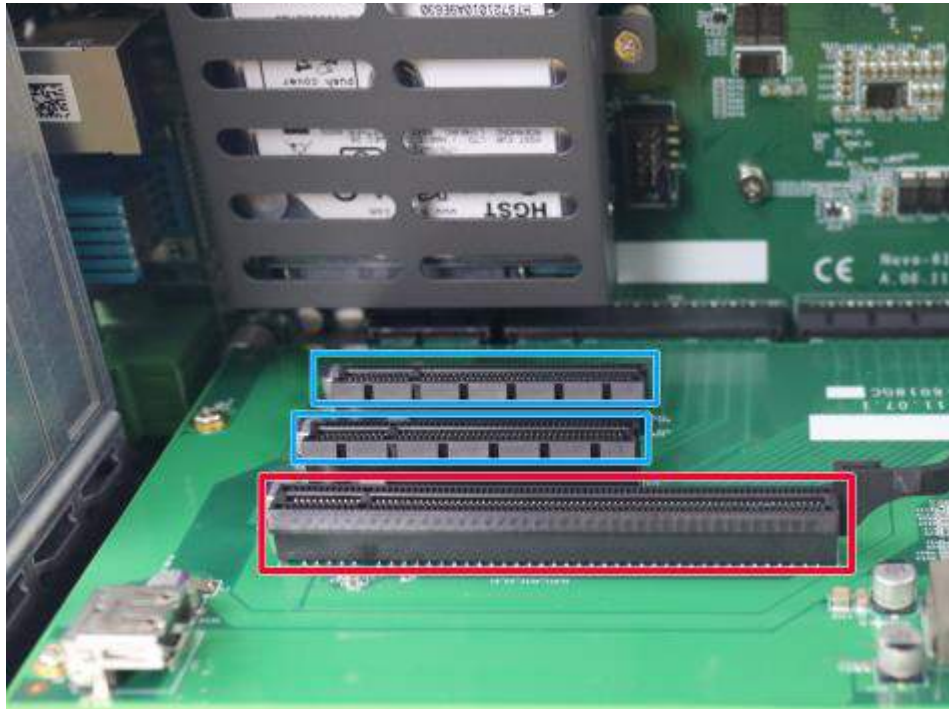

1. Please refer to the section “[Disassembling the System](#)”, you may not need to completely dismantle the system to gain access to the PCI/ PCIe slots.
2. Remove the corresponding bezel cover(s) for your PCI/ PCIe slot. Please note when installing a graphics card, you may need to remove two bezels.



**Bezel removal**

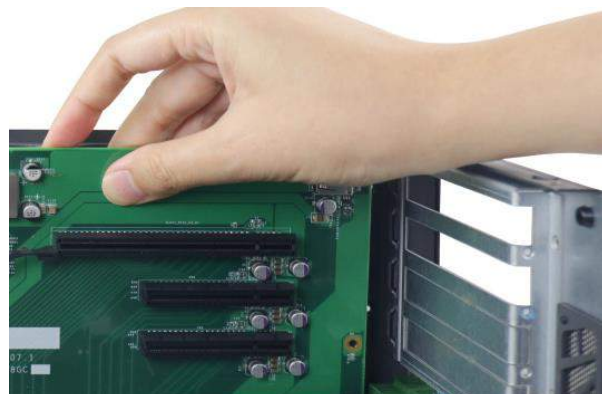

**Remove bezels for graphics card**



3. Install the PCIe graphics card support frame.



**Slide and insert the support frame**

**Secure frame with four screws**

4. When installing a graphics card, please make sure that you do not accidentally knock off the spacer on the inside of the support frame.



- To install the PCI/ PCIe card, gently lower and insert the card's gold fingers into the PCI/ PCIe slot; make sure the tab at the bottom of the bezel plate is inserted into the notch.



**Gently insert gold fingers into the slot**

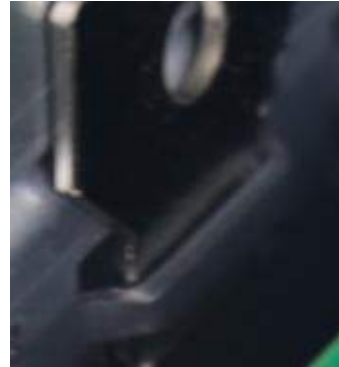

**Bezel tab inserted into notch**



**NVIDIA 1080**



**NVIDIA 1080Ti**



**Secure the graphics card**

6. Install the stabilizing bracket to hold the graphics card to the support frame.

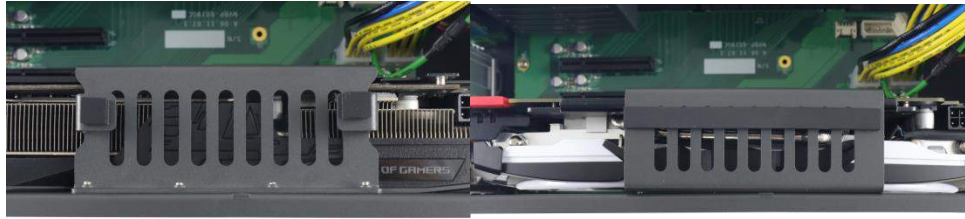

**NVIDIA 1080 stabilizing bracket**

**NVIDIA 1080Ti stabilizing bracket**

7. Secure the bracket with four screws



8. Connect the 8-pin and/ or 6-pin power supply for the card.



9. [Reinstall the system enclosure](#) and panel when done.
10. If you need to install other components, please refer to respective sections.

### 3.3 Installing the System Enclosure

1. To reinstall the system enclosure, place the side panel back onto the enclosure while making sure the two (2) notches are inserted into the slide-and-lock holes on enclosure frames.



**Place side panel onto enclosure**



**Slide-and-lock**

- Secure screws on the I/O panel highlighted in blue.

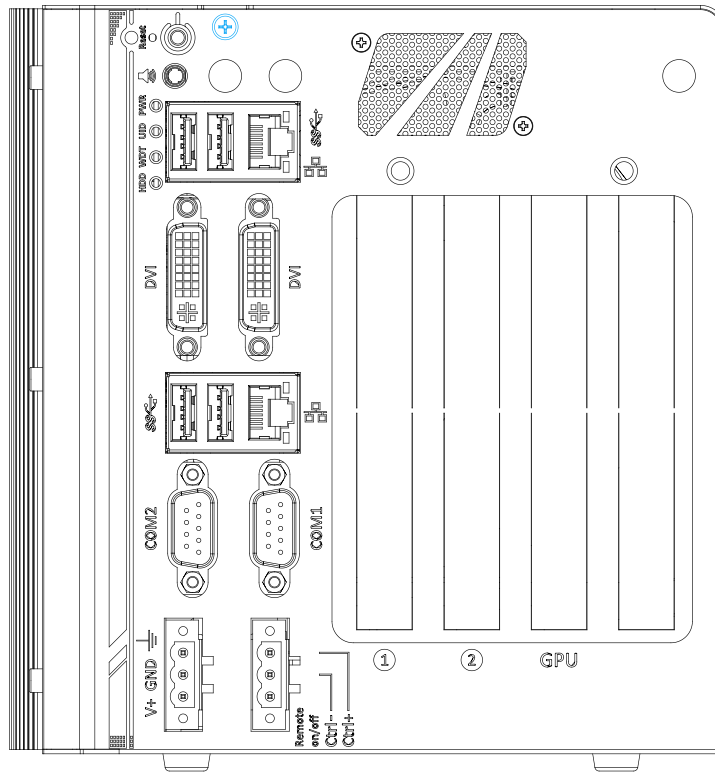

- Secure the screw on top of the enclosure highlighted in blue.

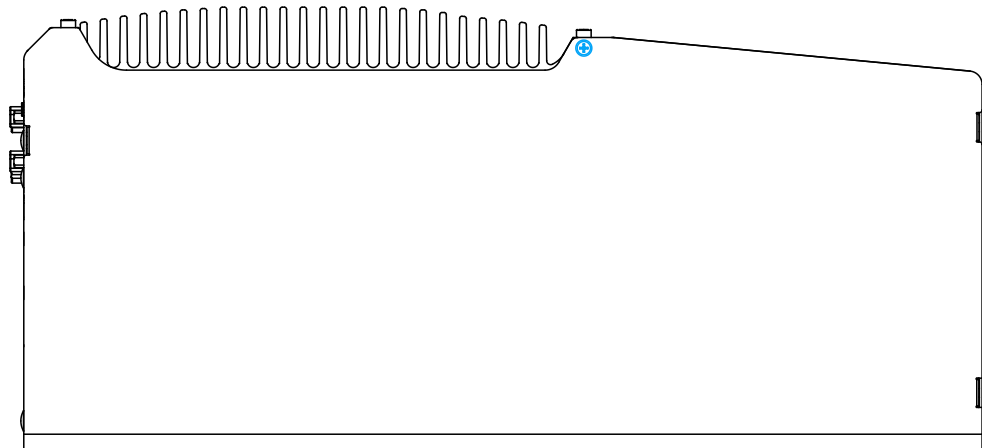

- Secure screws on the removable side panel highlighted in **blue**.

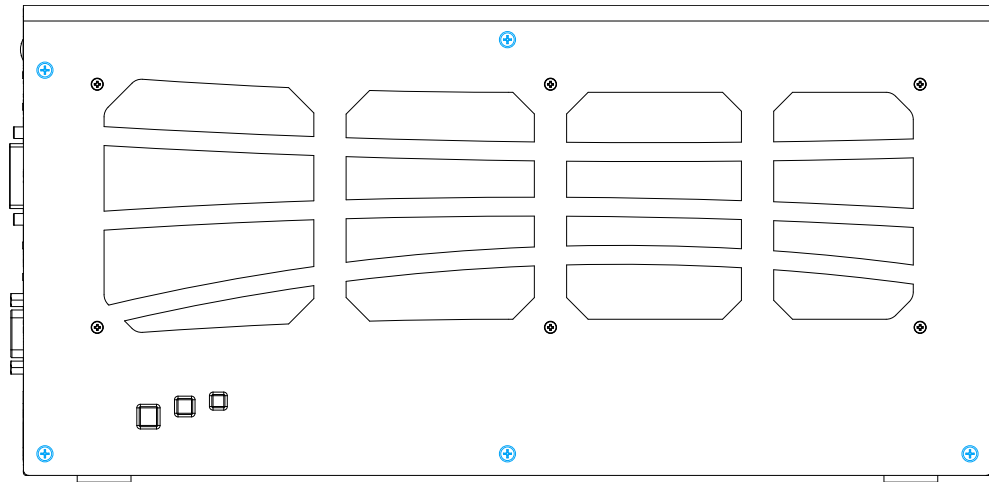

- Secure screws on the ventilation fan panel highlighted in **blue** to complete the enclosure installation process.

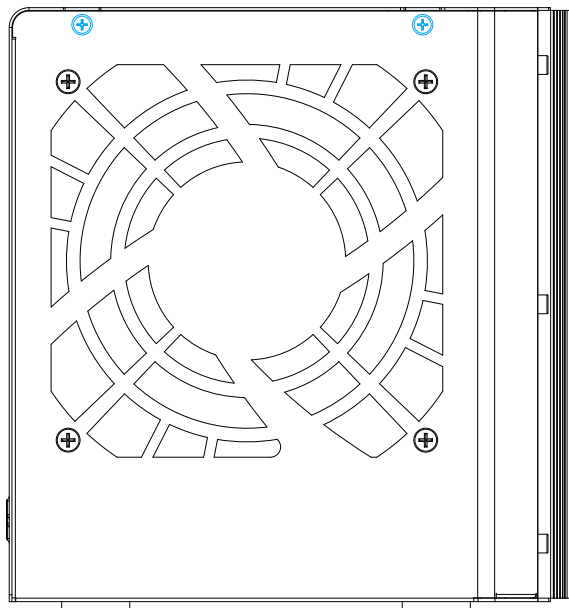

### 3.4 Anti-vibrate Grommet/ Wall Mount Bracket

#### Installation

There are eight anti-vibration grommets in the accessory box and two wall mount brackets. Secure the anti-vibration grommets and the wall mount brackets with M4 screws supplied as shown in the illustration below.

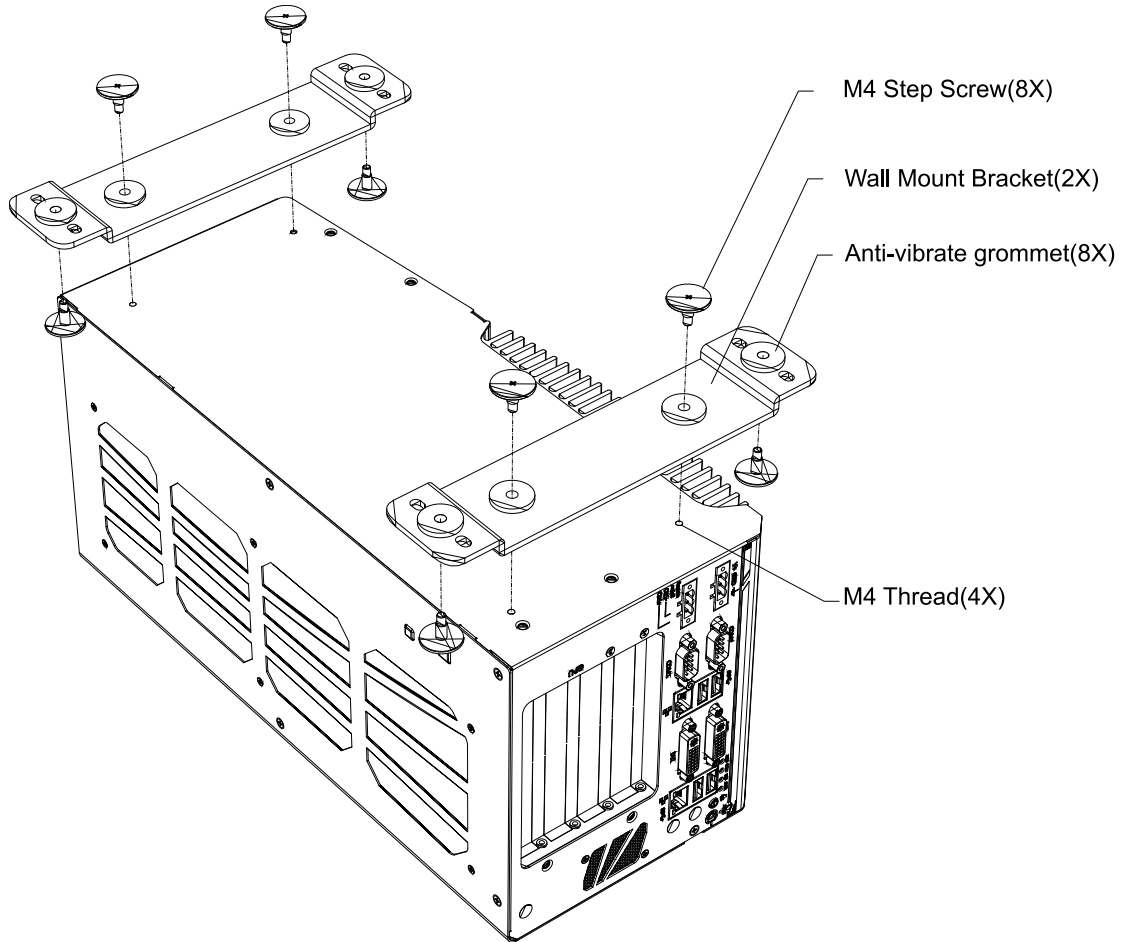

# 4 System Configuration

## 4.1 BIOS Settings

The system is shipped with factory-default BIOS settings meticulously programmed for optimum performance and compatibility. In this section, we'll illustrate some of BIOS settings you may need to modify. Please always make sure you understand the effect of change before you proceed with any modification. If you are unsure of the function you are changing, it is recommended to change one setting at a time to see its effect(s).

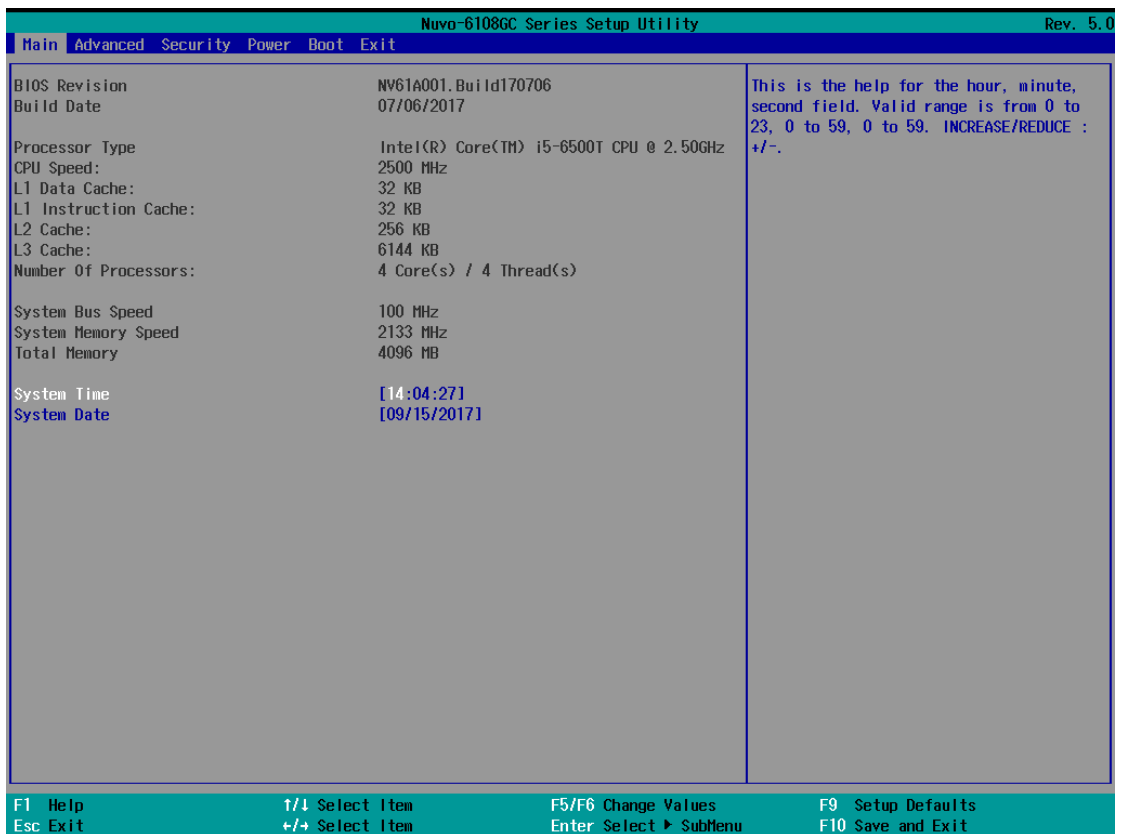

### NOTE

*Not all BIOS settings will be discussed in this section. If a particular setting/function you are after requires specific BIOS settings but is not discussed in this section, please contact Neousys Technical Support staff.*



### 4.1.1 COM1 & COM2 Configuration

The system's [COM1/ COM2](#) ports support RS-232 (full-duplex), RS-422 (full-duplex) and RS-485 (half-duplex) mode. You can set the COM1 operating mode via BIOS settings. Another option in BIOS called “*Slew Rate*” defines how sharp the rising/falling edge is for the output signal of COM1. For long-distance RS-422/485 transmission, you may set the “*Slew Rate*” option as “High” to improve signal quality. For RS-422/485 communication, the “*RS-422/485 Termination*” option determines whether to enable/disable internal termination of RS-422/485 transceiver according to your wiring configuration (e.g. with or without external termination).

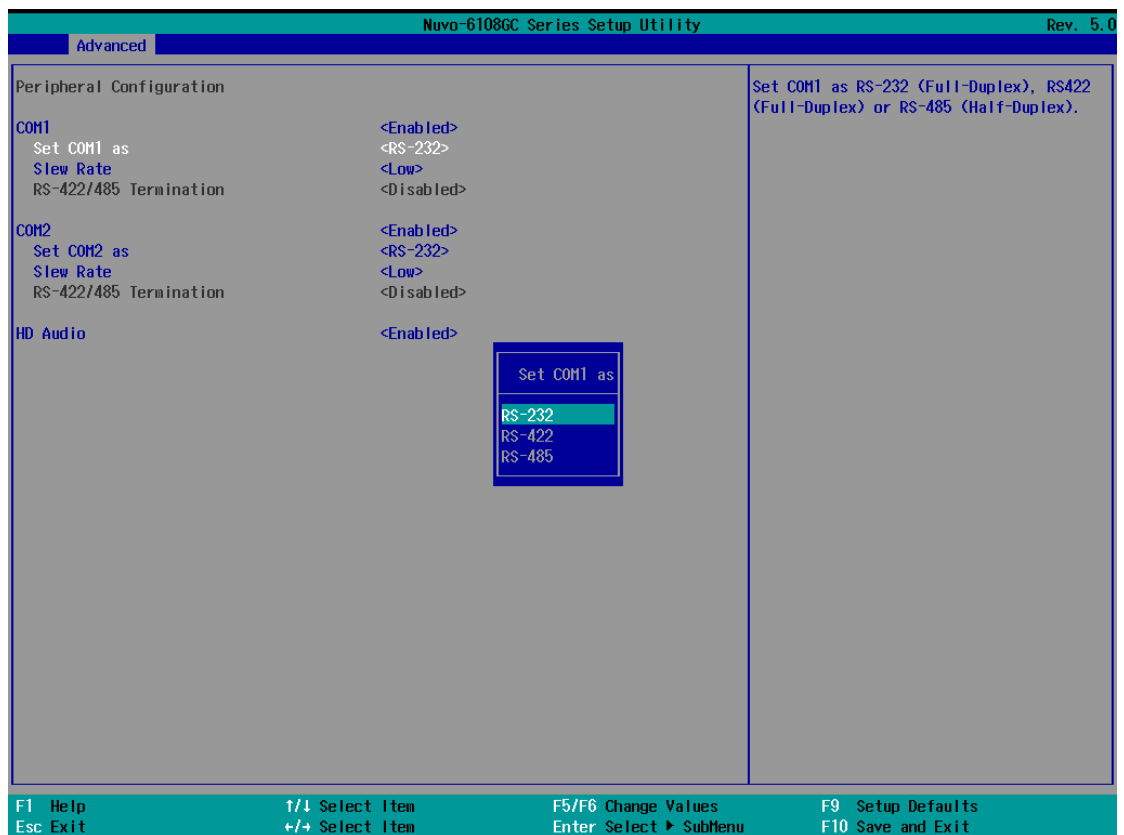

#### To set COM port operating mode:

1. Press **F2** when the system boots up to enter the BIOS setup utility.
2. Go to **[Advanced] → [Peripheral Configuration]**.
3. Set the **[Set COM1 Mode as]** option to the desired mode.
4. Once set, press **F10** to save setting and exit.

### 4.1.2 SATA Configuration

The SATA controller of your system supports two (2) operating modes: **AHCI** and **RAID** mode. The **AHCI** mode, which exposes SATA's advanced capabilities such as hot swapping and native command queuing, is supported in several later version of operating systems. **RAID** mode provides reliable data storage (RAID 0/ 1/ 5/ 10) or a higher throughput (RAID 0). No additional H/W or driver is needed to use RAID function.

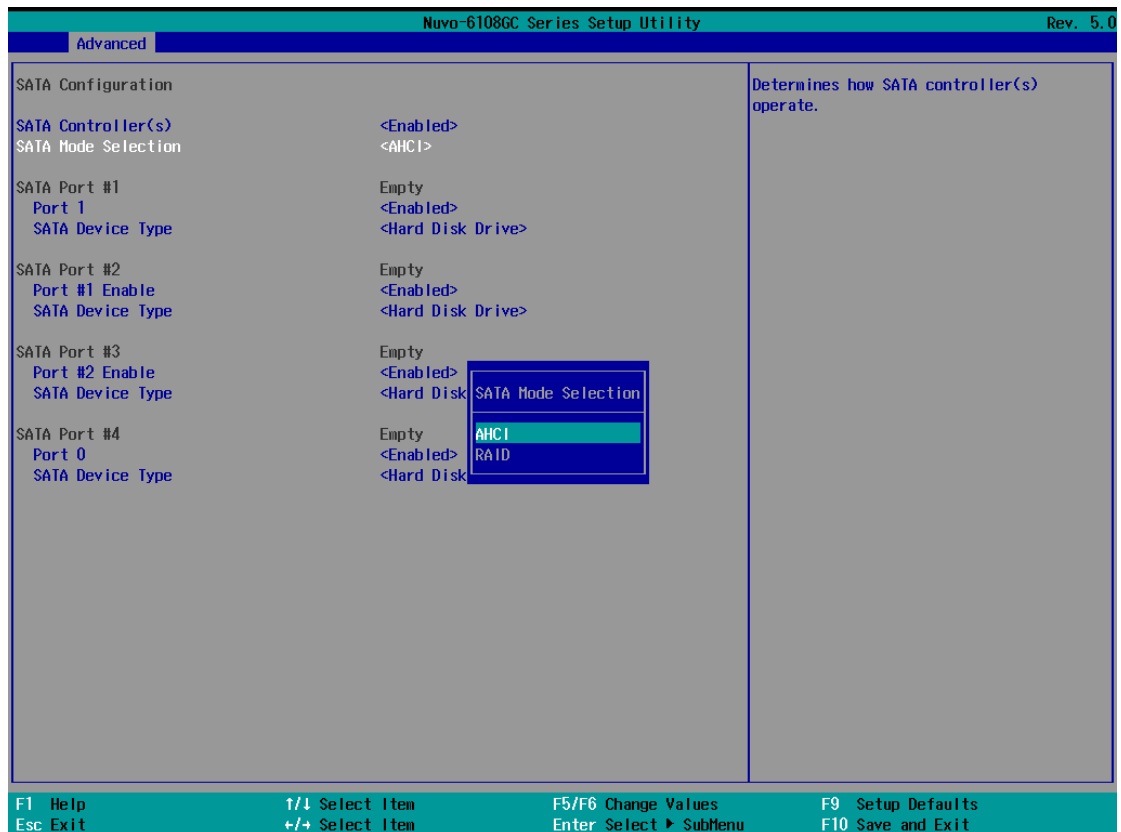

Recommended SATA controller mode settings:

- If you're using Windows Vista, Windows 7/ 8/ 10, or Linux kernel 2.6.19 or later, you can select **AHCI** mode for better performance.
- If you're installing two 2.5" HDD/ SSD and looking for data striping (RAID 0) or data mirroring (RAID 1), you can select **RAID** mode to utilize built-in RAID.

To set SATA controller mode:

1. When system boots up, press F2 to enter BIOS setup utility.
2. Go to **[Advanced] > [SATA Configuration]**.

3. Highlight the SATA port you wish to set and press Enter to bring up setting options. Scroll to and highlight the setting you wish to set and press Enter.
4. Repeat step 3 to set other SATA ports.
5. Press F10 to "Exit Saving Changes".

### 4.1.3 TPM Availability

Trusted Platform Module (TPM) is a hardware-based cryptoprocessor to secure hardware by integrating cryptographic keys into devices. The system is designed with on-board TPM 2.0 module. As TPM 2.0 requires 64-bit Windows 7/ 8/ 10 with UEFI boot mode, it is disable in BIOS by default. For customers who want to utilize TPM feature, you will need to enable TPM in BIOS as well as install Windows with UEFI mode.

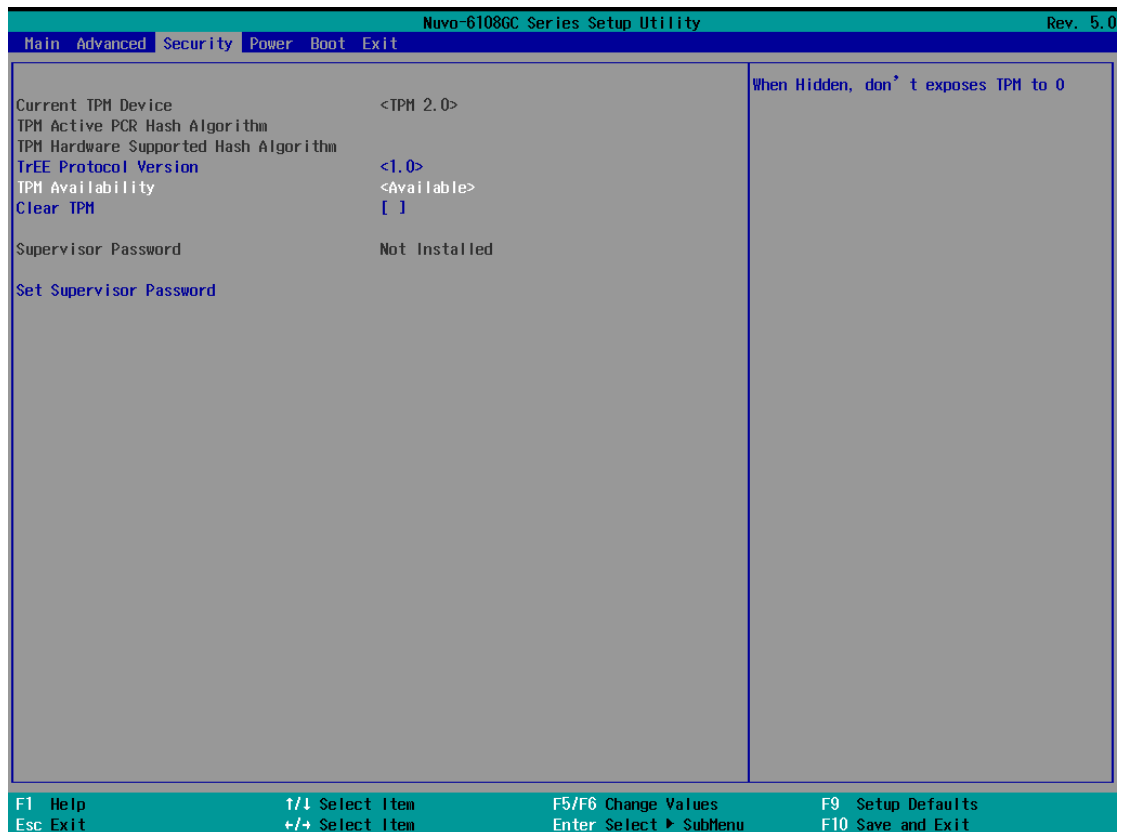

To enable TPM availability:

1. When system boots up, press F2 to enter BIOS setup utility.
2. Go to **[Security] > [TPM Availability]**, press Enter to bring up Options, Available/ Hidden.
3. Highlight your selection, press Enter and press F10 to “Exit Saving Changes”.

#### 4.1.4 Auto Wake on S5

Users can specify the S5 state reaction of the system in the event of a power failure.

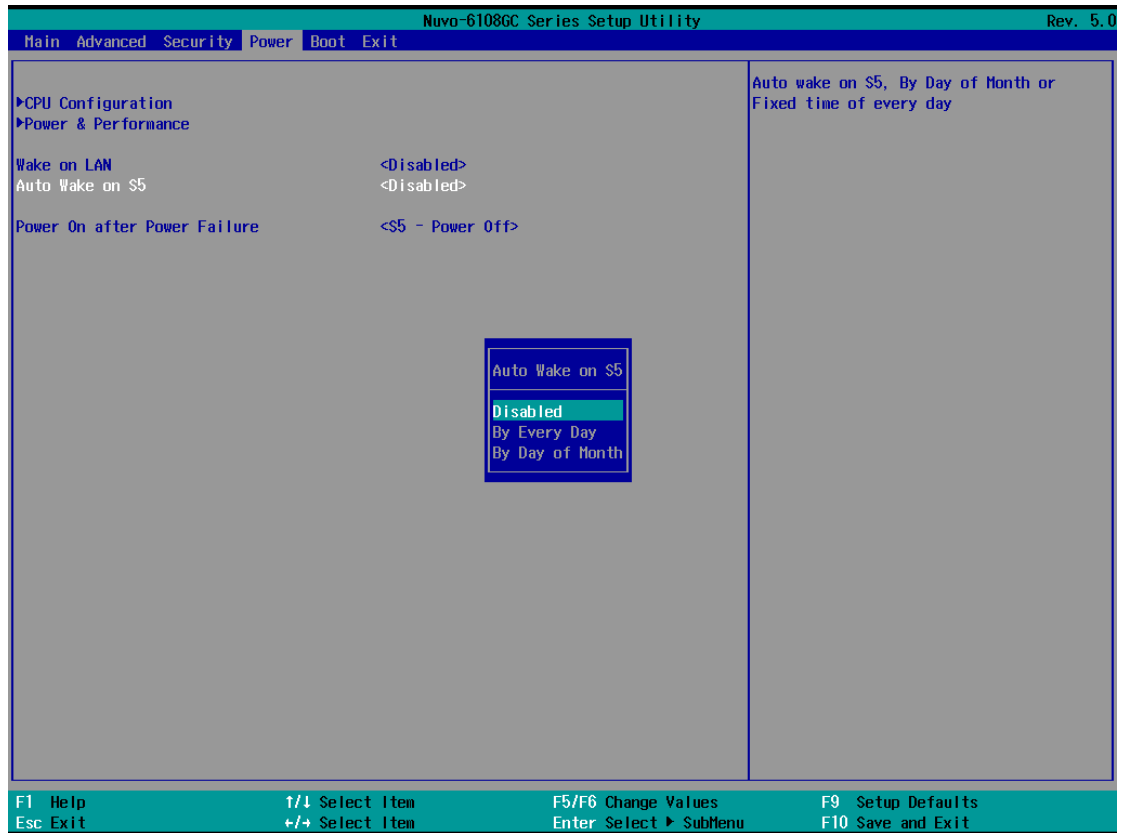

Value	Option	Description
Auto Wake on S5	Disabled	The system does not turn on when operating in state S5.
	By Every Day	The system turns on each day when operating in state S5. Specify the time of day.
	By Day of Month	The system turns on each month when operating in state S5. Specify the day and time.

Highlight your selection, press Enter and press F10 to “Exit Saving Changes”.

### 4.1.5 Power On After Power Failure Option

This option defines the behavior of System series when DC power is supplied.

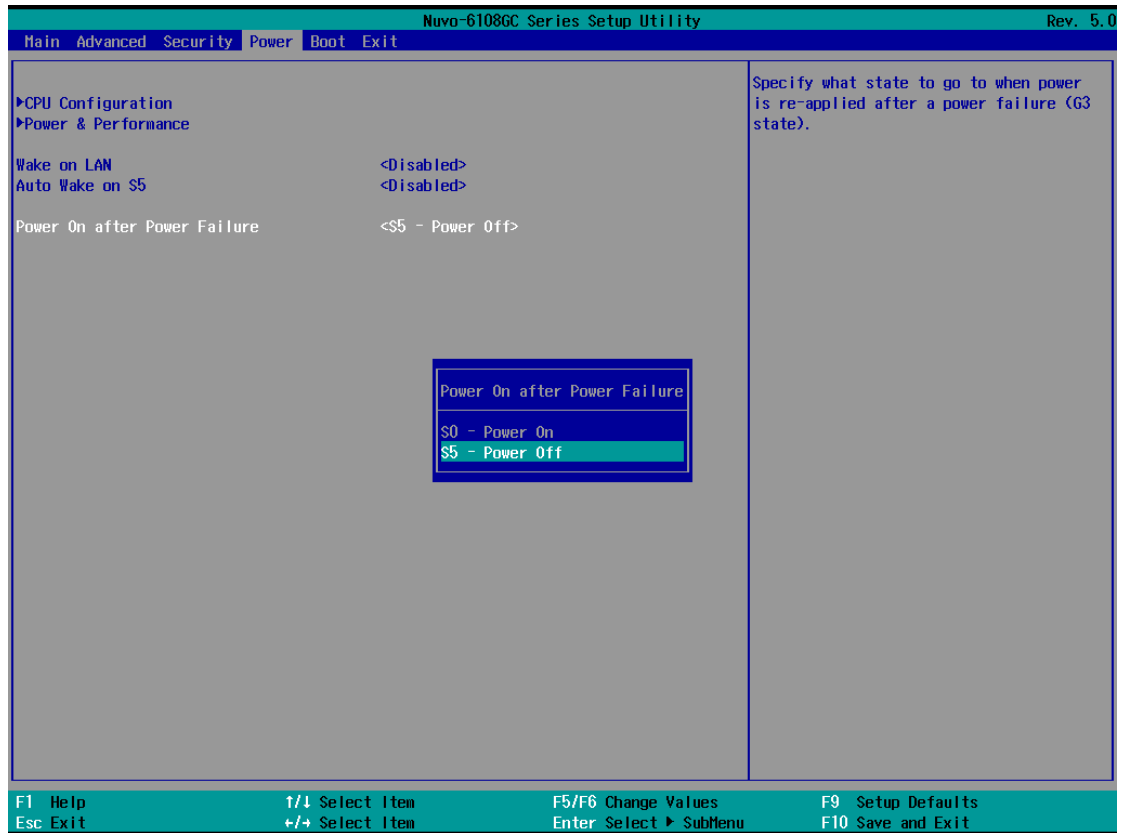

Value	Description
S0 – Power On	System is powered on when DC power is supplied.
S5 – Power Off	System is kept in off state when DC power is supplied.

To set “Power On after Power Failure” option:

1. When system boots up, press F2 to enter BIOS setup utility.
2. Go to **[Power] > [Power On after Power Failure]**.
3. Scroll down to highlight **[Power On after Power Failure]**, press Enter to bring up setting options, S0 – Power On or S5 – Power Off, and press Enter to select the setting.
4. Press F10 to “Exit Saving Changes”.

#### 4.1.6 Power & Performance (CPU SKU Power Configuration)

The system supports various 6<sup>th</sup>-Gen Skylake LGA1151 CPUs. A unique feature, “**SKU Power Config**” is implemented in BIOS to allow users to specify user-defined SKU power limit. Although the system is designed to have best thermal performance with CPUs of 35W TDP, you can install a 65W CPU and limit its SKU power (to35W) to obtain more computing power. This feature gives you the flexibility of CPU selection and great balance between computing power and operating temperature range.

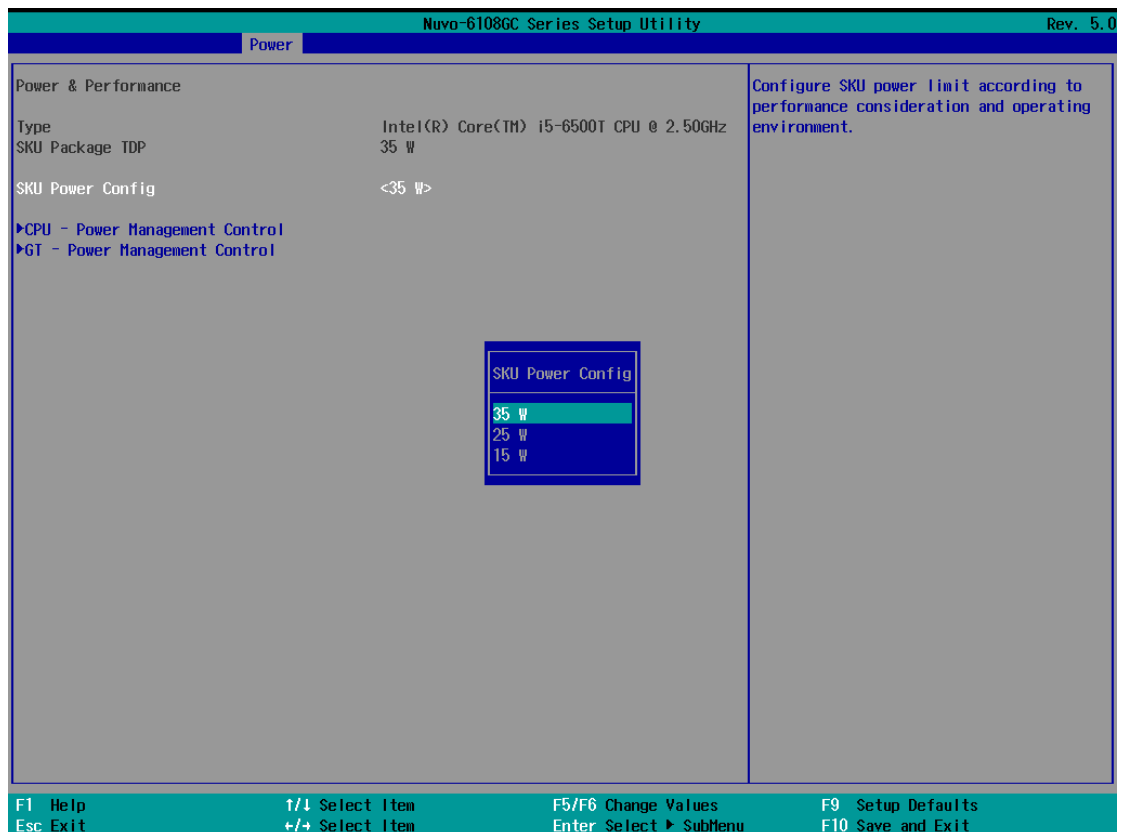

To configure the CPU SKU power limit:

1. When the system boots up, press F2 to enter BIOS setup utility.
2. Go to **[Power]** → **[Power & Performance]**.

Select a proper value of SKU power limit for **[SKU Power Config]** option.

### 4.1.7 Wake on LAN Option

Wake-on-LAN (WOL) is a mechanism which allows you to turn on your System series via Ethernet connection. To utilize Wake-on-LAN function, you have to enable this option first in BIOS settings. Please refer "[Powering On Using Wake-on-LAN](#)" to set up the system.



To enable/disable "Wake on LAN" option:

1. When system boots up, press F2 to enter BIOS setup utility.
2. Go to **[Power] > [Wake on LAN]**.
3. Press Enter to bring up setting options, scroll to the setting you desire and press Enter to set.
4. Press F10 to "Exit Saving Changes."



### 4.1.8 Boot Menu

The Boot menu in BIOS allows you to specify the system’s boot characteristics by setting bootable device components (boot media) and method. Or, you may press F12 upon system start up and select a device you wish boot from.

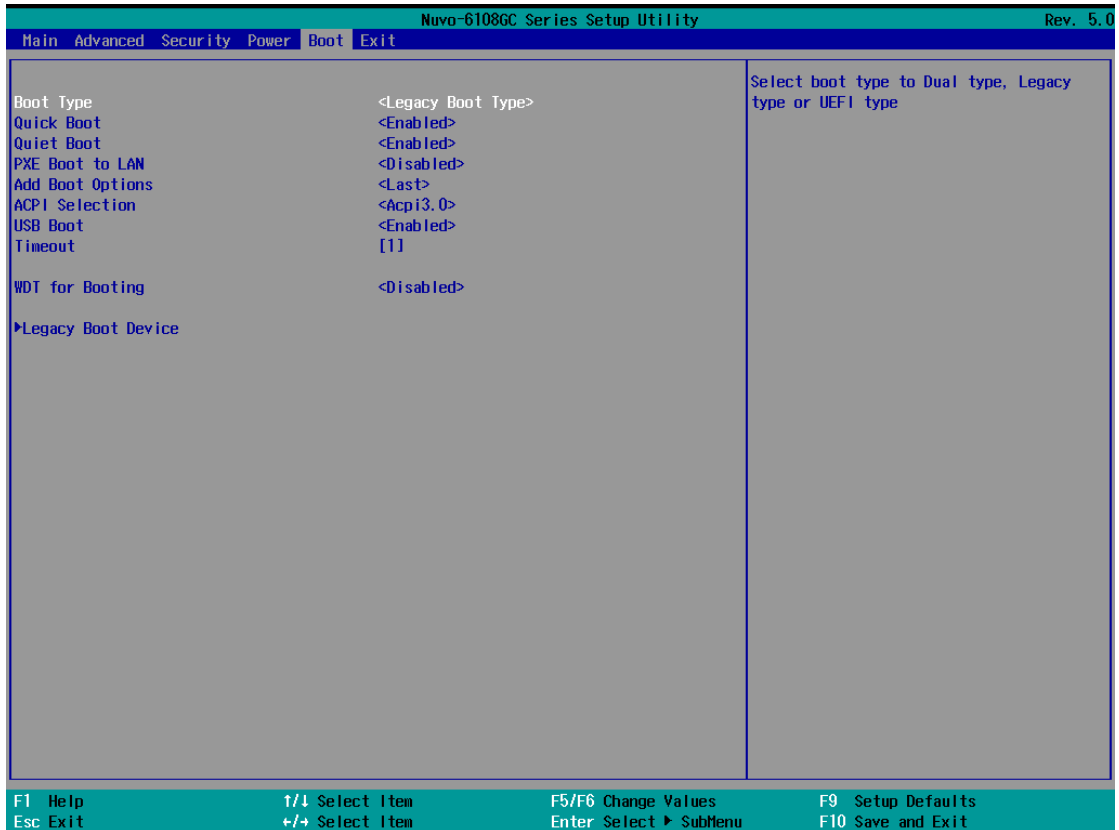

Value	Option	Description
<a href="#">Boot Type</a>	Dual Boot Type	Both legacy and EFI boot media listed are approved as boot media.
	Legacy Boot Type	Only legacy boot media listed are approved as boot media.
	UEFI Boot Type	Only legacy boot media listed are approved as boot media.
Quick Boot	Enabled	The system starts up faster because BIOS skips various hardware function tests
	Disabled	The system starts up slower because BIOS goes through various hardware functions tests
Network Stack	Enabled	The system is available for network access using UEFI.
	Disabled	The system is not available for network access using UEFI.

PXE Boot capability	Disabled	Only UEFI Network Stack is supported: Preboot eXecution Environment (PXE) is not supported
	Enabled	By enabling the PXE boot, one can choose to boot via <b>I219 Only/ I210 Only</b> or <b>All NICs</b> .
Add Boot Options	First	Newly detected boot media are placed at the top of the boot order.
	Last	Newly detected boot media are placed at the bottom of the boot order.
ACPI Selection	1.0B/ 3.0/ 4.0/ 5.0/ 6.0	Advanced Configuration and Power Interface allows the operating system to control system power management
USB Boot	Enabled	Allow boot from bootable USB devices.
	Disabled	Does not allow boot from bootable USB devices
EFI Device First	Enabled	Set to boot bootable EFI media first.
	Disabled	Will not boot bootable EFI media first.
Timeout	1, 2, 3, etc (in seconds)	Boot delay time in seconds to give the user time to activate the hotkey to access the BIOS
<a href="#">WDT for booting</a>	Disabled, 1, 3, 5, 10 (minutes)	WDT ensures a successful system boot by specifying a timeout value

### 4.1.9 Boot Type (Legacy/ UEFI)

The system supports both Legacy and Unified Extensible Firmware Interface (UEFI) boot modes. UEFI is a specification proposed by Intel to define a software interface between operating system and platform firmware. Most modern operating systems, such as Windows 7/8/10 and Linux support both Legacy and UEFI boot modes. The Legacy boot mode uses MBR partition for disk and VBIOS for video initialization, the UEFI boot mode uses GPT partition which supports greater than 2TB partition size and GOP driver for faster video initialization.

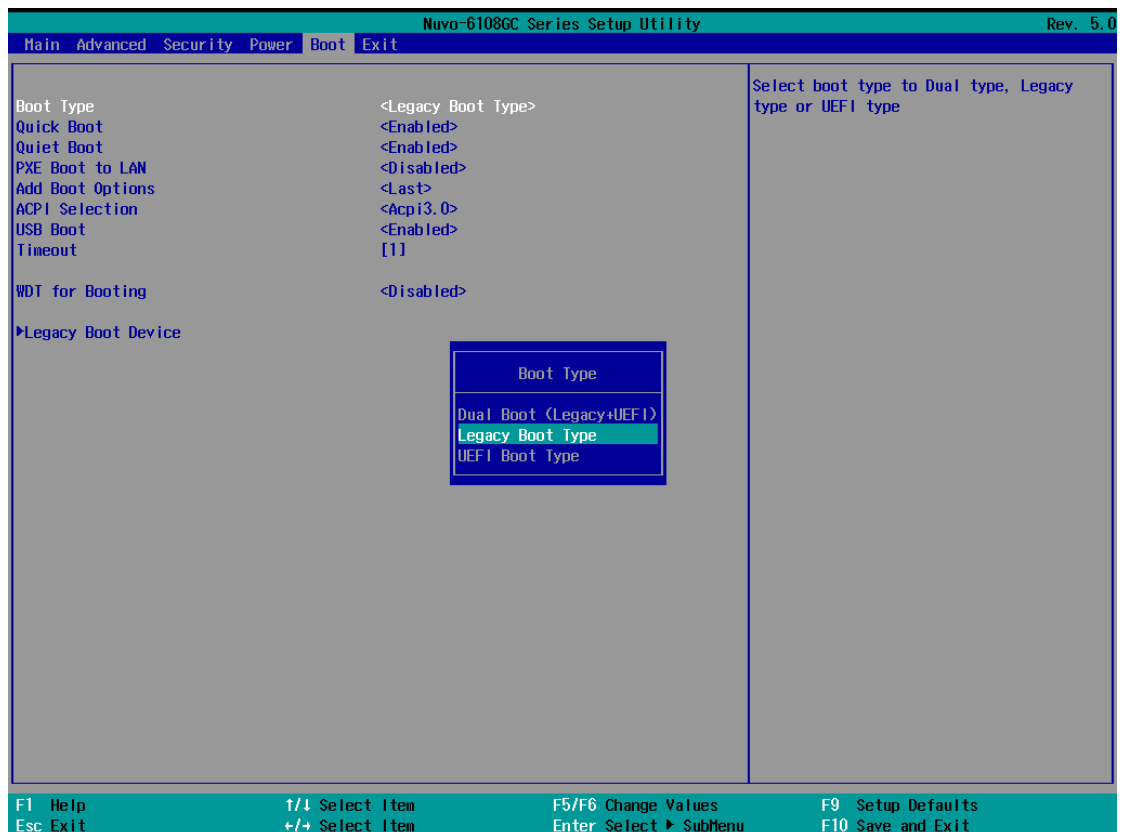

It is recommended that:

- If you need greater than 2TB disk partition or want to use TPM 2.0 function, you shall choose UEFI boot mode and install operating system accordingly.
- Choose Legacy boot mode if the installed HDD/ SSD capacities are under 2TB

To configure Boot Type:

1. When system boots up, press F2 to enter BIOS setup utility.
2. Go to **[Boot] > [Boot Type]**, press Enter to bring up options, Dual Boot (Legacy+UEFI), Legacy Boot Type, UEFI Boot Type.

3. Highlight your selection and press Enter.
4. Press F10 to "Exit Saving Changes".

#### 4.1.10 Position New Boot Device

The “Add Boot Options” allow you to determine whether a newly added device (eg. USB flash disk) is to boot as the first device to boot or the last in the boot sequence.

To set the newly-installed boot device as the first or last boot device:

1. Press **F2** when the system boots up to enter the BIOS setup utility.
2. Go to **[Boot] > [Add Boot Options]** menu.
3. Select **[First]** or **[Last]** for your newly-added boot device and press Enter.
4. Once set, press **F10** to save setting and exit.



### 4.1.11 Watchdog Timer for Booting

The watchdog timer secures the boot process by means of a timer. Once the timer expires, a reset command is issued to initiate another booting process. There are two options in BIOS menu, “*Automatically after POST*” and “*Manually after Entering OS*”. When “*Automatically after POST*” is selected, the BIOS automatically stops the watchdog timer after POST (Power-On Self Test) OK. When “*Manually after Entering OS*” is selected, the user must stop the watchdog timer once booted into the OS. This guarantees the system can always boot into the OS, otherwise another booting process will be initiated. For information about programming watchdog timer, please refer to [Watchdog Timer & Isolated DIO](#).

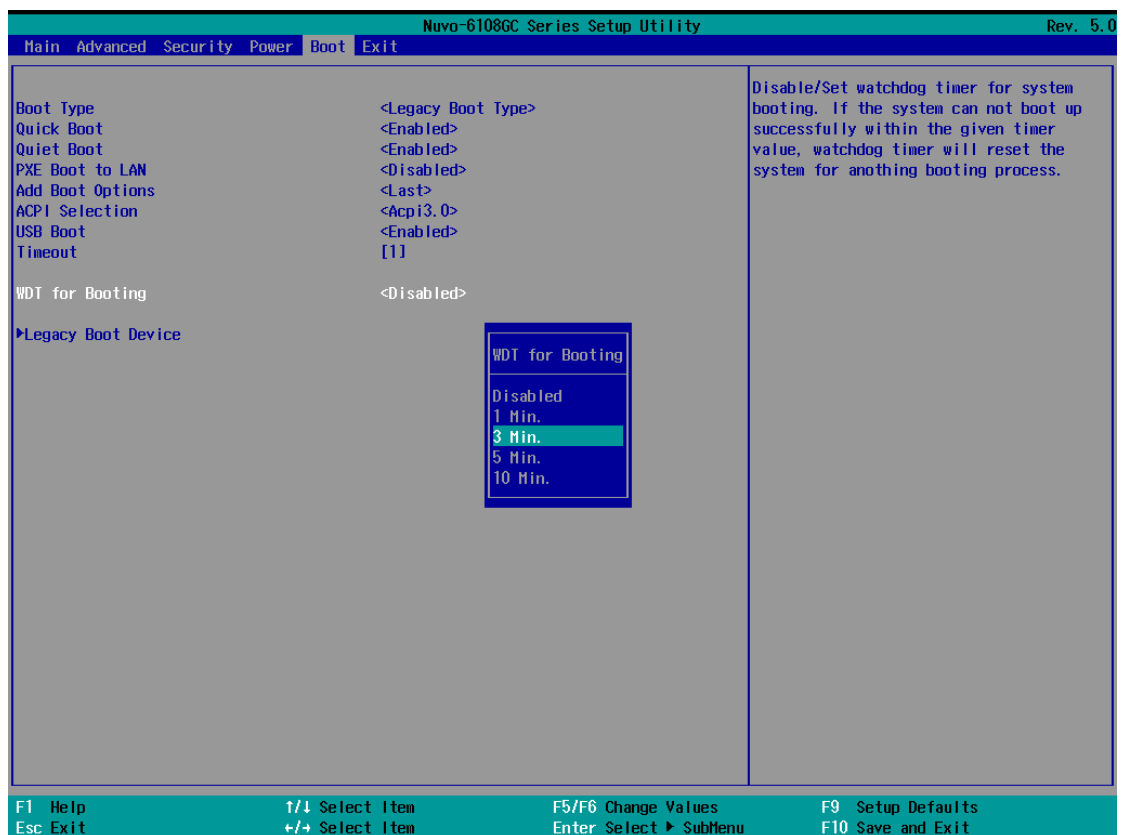

To set the watchdog timer for boot in BIOS:

1. When system boots up, press F2 to enter BIOS setup utility.
2. Go to **[Boot]** menu.
3. Disable or select timeout value for **[WDT for Booting]** option.
4. Once you give a timeout value, the **[WDT Stop Option]** option appears. You can select “*Automatically after POST*” or “*Manually after Entering OS*”.
5. Press F10 to “Exit Saving Changes.

#### 4.1.12 Legacy/ UEFI Boot Device

When you wish to set a designated boot device, you may set it as the first device to boot in Legacy or UEFI Boot Device setting. Or if you wish to manually select a boot device, you may do so by pressing F12 when the system boots up.



To set boot order for devices in UEFI Boot Device:

1. When system boots up, press F2 to enter BIOS setup utility
2. Go to **[Boot] > [UEFI Boot Device]**
3. Highlight the device you wish to make boot order changes to and press F5/ F6 or +/- to change device boot order.

To select boot order for devices in Legacy Boot Device:

1. When system boots up, press F2 to enter BIOS setup utility
2. Go to **[Boot] > [Legacy Boot Device]**, you can choose the type of device to list by selecting "By Device or By Device Type".
3. Highlight the device you wish to make boot order changes to and press F5/ F6 or +/- to change device boot order.

## 4.2 AMT Configuration

Intel® AMT (Active Management Technology) is a hardware-based technology for remotely managing target PCs via Ethernet connection. The system supports AMT function via its Ethernet port implemented with Intel I219-LM. In prior to use AMT to remotely control the system, you need to configure AMT password and network settings.

1. Connect Ethernet cable to I219-LM Ethernet port (indicated in **blue**).

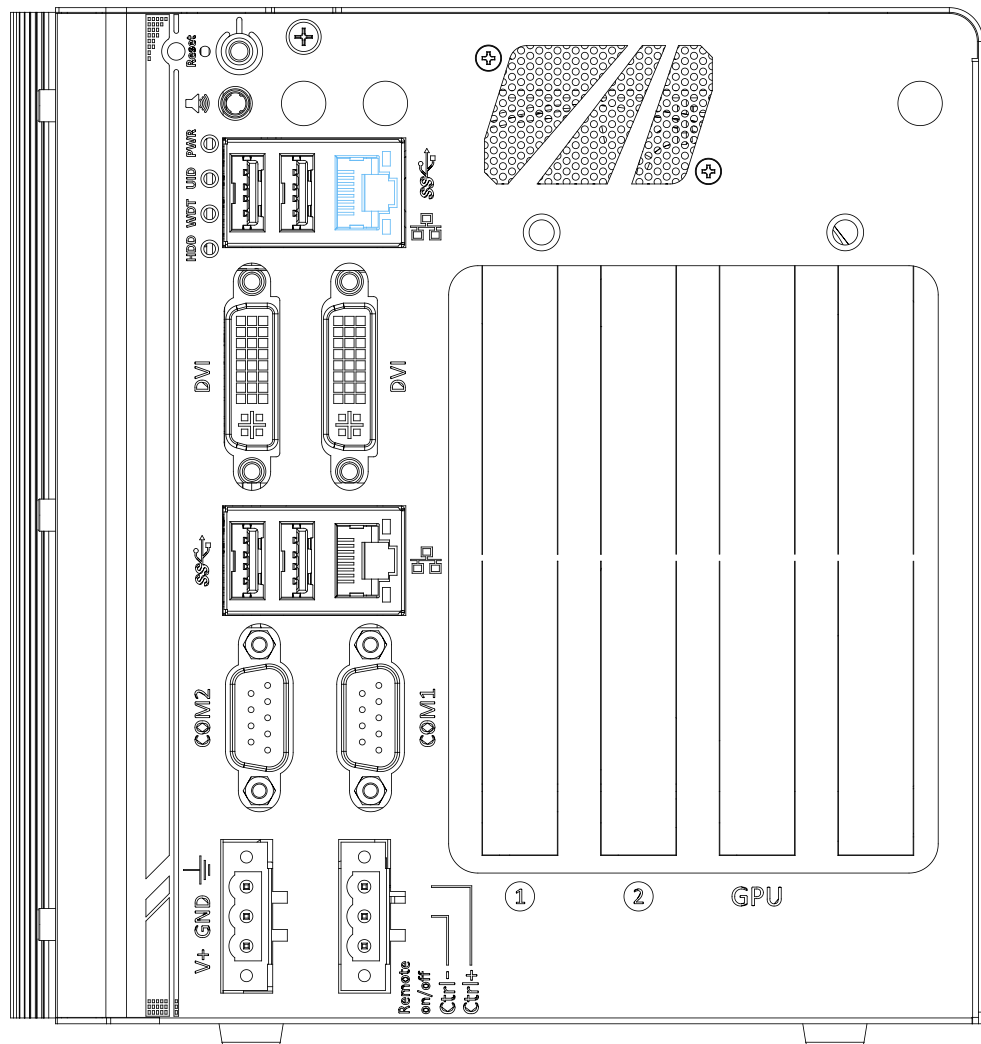



- When the system boots up, press F10 to enter the MEBx configuration menu.

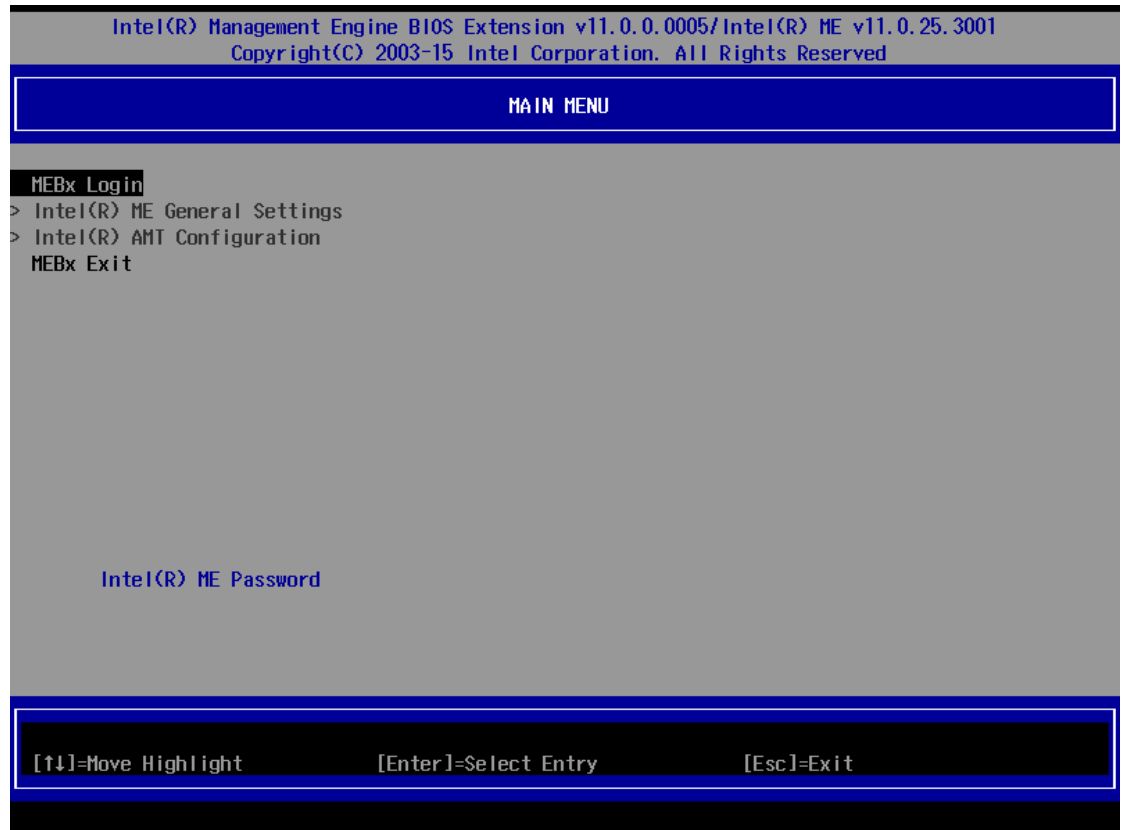

- Highlight MEBx Login and press Enter, a prompt will appear asking for password. The default password is “admin”. For further MEBx configuration details, please refer to [Intel® MEBX User Guide](#).

### 4.3 RAID Configuration

The system supports RAID 0/ 1/ 5/ 10 options. To utilize the RAID function, the minimum HDDs/ SSDs must be installed for the following RAID configurations:

- RAID 0/ 1:** Two HDDs/ SSDs
- RAID 5:** At least three HDDs/ SSDs
- RAID 10:** At least four HDDs/ SSDs

 **NOTE**

*It is recommended that the HDDs/ SSDs used are of the same model, same capacity, rpm, etc. to avoid compatibility or performance bottleneck.*

To set up RAID configuration, you need to pre-configure the SATA mode setting in the BIOS. Please refer to the following steps:

1. When system boots up, press **F2** to enter BIOS setup utility.
2. Go to **[Advanced] > [SATA Mode Selection]** and press ENTER.

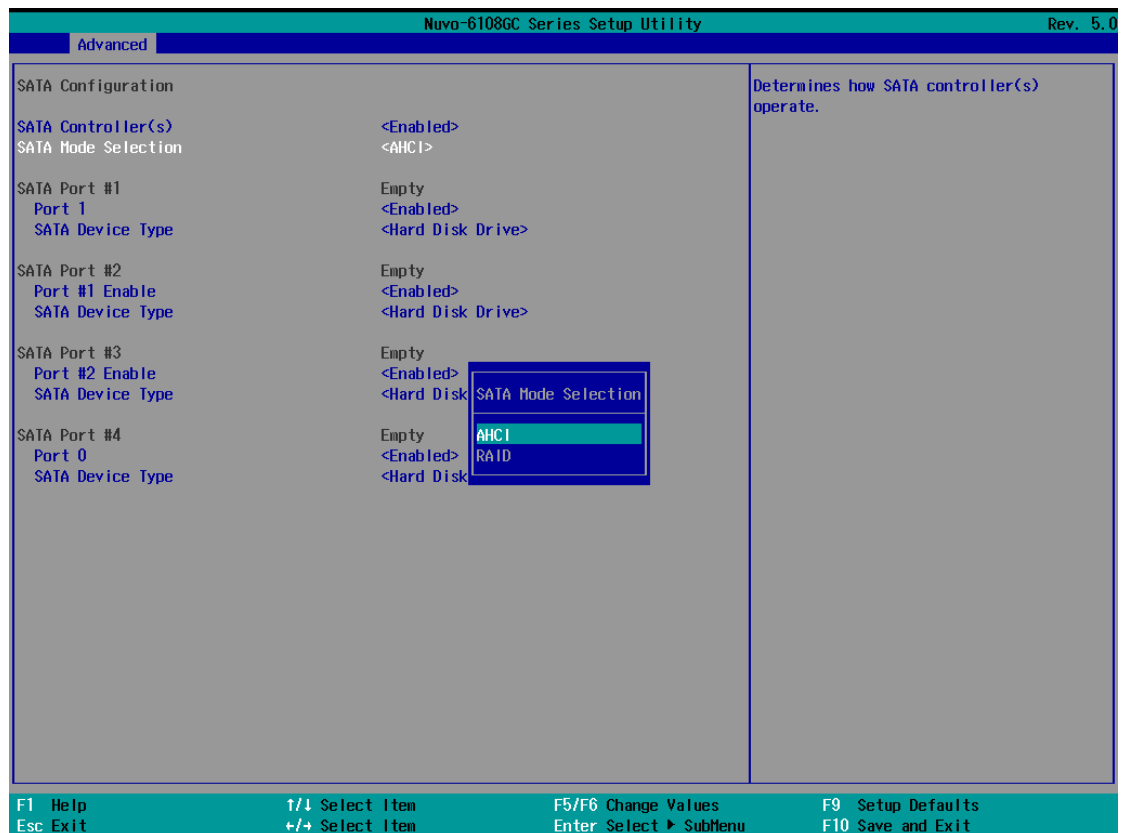

3. Highlight **“RAID”** and press ENTER to make your selection.
4. Press **F10** to Save and exit the BIOS.

5. Upon reboot, press “**Ctrl + I**” to enter the RAID configuration utility

```

[ MAIN MENU ]
1. Create RAID Volume
2. Delete RAID Volume
3. Reset Disks to Non-RAID
4. Recovery Volume Options
5. Acceleration Options
6. Exit
[ DISK/VOLUME INFORMATION ]

RAID Volumes:
ID Name Level Strip Size Status Bootable
0 Volume0 RAID0(Stripe) 32KB 119.2GB Normal Yes

Physical Devices:
ID Device Model Serial # Size Type/Status(Vol ID)
0 SAMSUNG MZRPC120 S0T6NY0BC63455 59.6GB Member Disk(0)
1 SAMSUNG MZRPC120 S0T6NY5BC63455 59.6GB Member Disk(0)
  
```

Please refer to the on screen RAID MENU options and instructions for configuration.

## 5 OS Support and Driver Installation

### 5.1 Operating System Compatibility

The system supports most operating system developed for Intel® x86 architecture. The following list contains the operating systems which have been tested by Neosys Technology.

- Microsoft Window 8 (x64)
- Microsoft Window 10 (x64)
- CentOS 7
- Debian 8.7\*\*
- Fedora 24\*\*
- OpenSUSE 42.1\*\*
- Ubuntu 14.04.4 LTS and 16.04 LTS\*\*



#### NOTE

*\* For Linux system, user may need to manually compile and install the driver for Intel graphics or I210 GbE controller if the driver is not embedded in kernel. You can visit Intel website for further information.*

*\*\* For distributions, graphics driver and RAID function may not be completely implemented in its kernel. You may encounter restrictions when using these features, such as triple independent display and RAID. For optimum operation, it is the users' responsibility to manually check for new drivers and upgrades!*

Neosys may remove or update operating system compatibility without prior notice. Please contact us if your operating system of choice is not on the list.

## 5.2 Driver Installation

The system comes with a “Drivers & Utilities” DVD that offers “one-click” driver installation process. It automatically detects your Windows operating system and installs all necessary drivers for you system with a single click.

### 5.2.1 Install Drivers Automatically

To install drivers automatically, please refer to the following procedures.

1. Insert the “Drivers & Utilities” DVD into a USB DVD-drive connect to your system. A setup utility launches and the following dialog appears.



Click on “**Automatic Driver Installation**” and the setup utility will automatically detect your Windows operating system and install all necessary drivers. The installation process takes about 6~8 minutes depending on your Windows version. Once driver installation is done, the setup utility reboots your Windows and you may begin using your system.

## 5.2.2 Install Drivers Manually

You can also manually install each driver for the system. Please note when installing drivers manually, you need to install the drivers in the following sequence mentioned below.

### Windows 10 (x64)

The recommended driver installation sequence is

1. Chipset driver (x:\Driver\_Pool\Chipset\_10\_APL\Win\_ALL\SetupChipset.exe)
2. Graphics driver  
(x:\Driver\_Pool\Graphics\_SKL\_APL\Win\_7\_8\_10\_APL\_64\Setup.exe)
3. Audio driver (x:\Driver\_Pool\Audio\_ALC262\Win\_ALL\_64\Setup.exe)
4. LAN driver  
(x:\Driver\_Pool\GbE\_I210\_I350\Win\_ALL\_64\APPS\PROSETDX\Win10\_x64\  
DxSetup.exe)
5. ME driver (x:\Driver\_Pool\ME\_10\_Series\Win\_ALL\_AMT\SetupME.exe)

## 5.3 Driver Installation for Watchdog Timer Control

Neosys provides a driver package which contain function APIs for Watchdog Timer control function. You should install the driver package (WDT\_DIO\_Setup.exe) in prior to use these functions. Please note that you must install WDT\_DIO\_Setup\_v2.2.6 or later versions.

### **Windows 7/ 8/ 10 (x64)**

Please execute the driver setup program in the following directory.

x:\Driver\_Pool\WDT\_DIO\Win7\_8\_64\WDT\_DIO\_Setup\_v2.2.6(x64).exe

### **Windows 7/ 8/ 10 (WOW64)**

Please execute the driver setup program in the following directory.

x:\Driver\_Pool\WDT\_DIO\Win7\_8\_WOW64\WDT\_DIO\_Setup\_v2.2.6(wow64).exe

# Appendix A Using WDT & DIO

The watchdog timer (WDT) function is to ensure reliable system operation. The WDT is a hardware mechanism to reset the system if the watchdog timer expires. Users can start the WDT and keeping resetting the timer to make sure the system or program is running. Otherwise, the system will reset.

In this section, we'll illustrate how to use the function library provided by Neosys to program the WDT functions. Currently, WDT driver library supports Windows 10 x64 and WOW64 platform. For other OS support, please contact Neosys Technology for further information.

## Installing WDT\_DIO Library

The WDT\_DIO function library is delivered in the form of a setup package named **WDT\_DIO\_Setup.exe**. In prior to program WDT, you should execute the setup program and install the WDT library. Please use the following WDT\_DIO\_Setup packages according to your operating systems and application.

- For Windows 10 64-bit OS with 64-bit application (x64 mode), please install WDT\_DIO\_Setup\_v2.2.6(x64).exe or later version.
- For Windows 10 64-bit OS with 32-bit application (WOW64 mode), please install WDT\_DIO\_Setup\_v2.2.6(wow64).exe or later version.



## WDT and DIO Library Installation

To setup WDT & DIO Library, please follow instructions below.

1. Execute **WDT\_DIO\_Setup.2.2.6.exe**. and the following dialog appears.

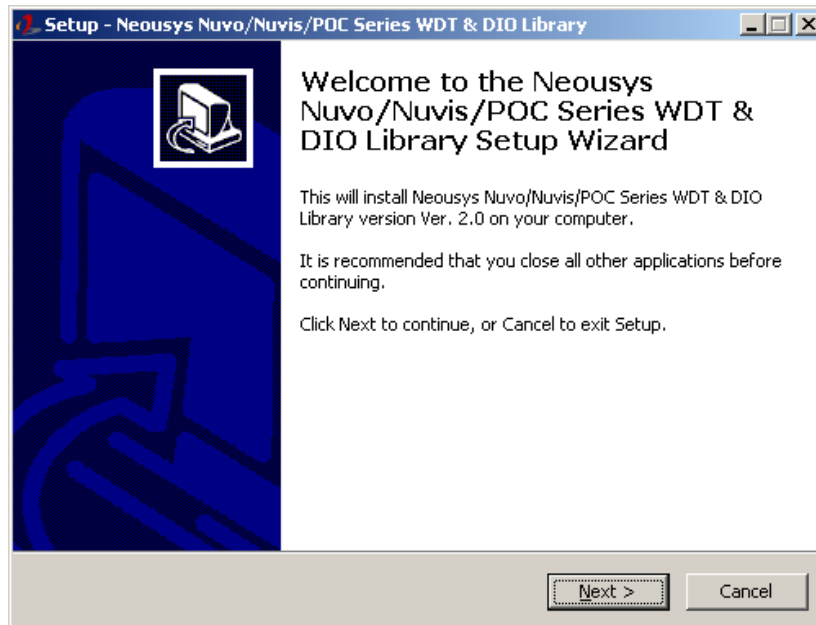

2. Click "Next >" and specify the directory of installing related files. The default directory is *C:\Neosys\WDT\_DIO*.

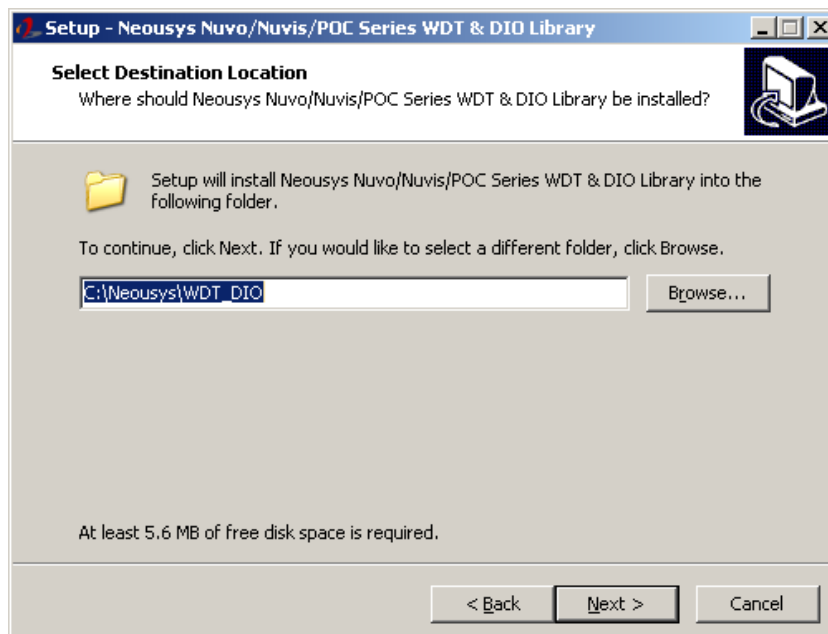

- Once the installation has finished, a dialog will appear to prompt you to reboot the system. The WDT & DIO library will take effect after the system has rebooted.

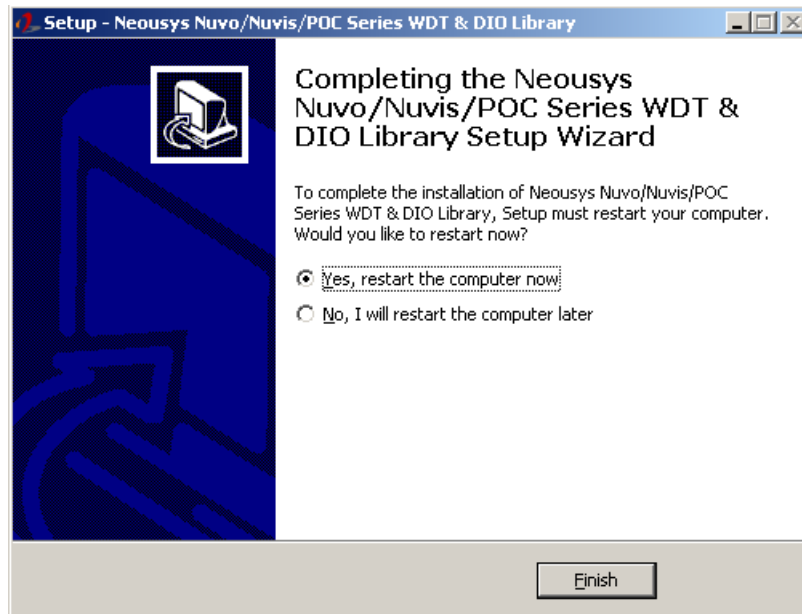

- When programming your WDT or DIO program, the related files are located in

<b>Header File:</b>	\Include
<b>Library File:</b>	\Lib
<b>Function Reference:</b>	\Manual
<b>Sample Code:</b>	\Sample\WDT_Demo (Demo for Watchdog Timer)

## WDT Functions

### InitWDT

<b>Syntax</b>	BOOL InitWDT(void);
<b>Description:</b>	Initialize the WDT function. You should always invoke InitWDT() before set or start watchdog timer.
<b>Parameter</b>	None
<b>Return Value</b>	<b>TRUE:</b> Successfully initialized <b>FALSE:</b> Failed to initialize
<b>Usage</b>	BOOL    bRet = InitWDT()

### SetWDT

<b>Syntax</b>	BOOL SetWDT(WORD tick, BYTE unit);
<b>Description</b>	Set timeout value and unit for watchdog timer. When InitWDT() is invoked, a default timeout value of 255 seconds is assigned.
<b>Parameter</b>	<i>tick</i> WORD value (1 ~ 65535) to indicate timeout ticks. <i>unit</i> BYTE value (0 or 1) to indicate unit of timeout ticks. 0 : unit is minute 1 : unit is second
<b>Return Value</b>	If value of unit is correct (0 or 1), this function returns TRUE, otherwise FALSE.
<b>Usage</b>	WORD    tick=255; BYTE    unit=1; //unit is second. BOOL    bRet = SetWDT(tick, unit); //timeout value is 255 seconds

### StartWDT

<b>Syntax</b>	BOOL StartWDT(void);
<b>Description</b>	Starts WDT countdown. Once started, the WDT LED indicator will begin blinking. If ResetWDT() or StopWDT is not invoked before WDT countdowns to 0, the WDT expires and the system resets.
<b>Parameter</b>	None
<b>Return Value</b>	If the timeout value is given in correct format (WDT started), this function returns TRUE, otherwise FALSE
<b>Usage</b>	BOOL    bRet = StartWDT()

### ResetWDT

<b>Syntax</b>	BOOL ResetWDT(void);
<b>Description</b>	Reset the timeout value to the value given by SetWDT().If ResetWDT() or StopWDT is not invoked before WDT countdowns to 0, the WDT expires and the system resets.
<b>Parameter</b>	None
<b>Return Value</b>	Always returns TRUE
<b>Usage</b>	BOOL    bRet = ResetWDT()

### StopWDT

<b>Syntax</b>	BOOL StopWDT(void);
<b>Description</b>	Stops the countdown of WDT. When WDT has stopped, the WDT LED indicator stops blinking.
<b>Parameter</b>	None
<b>Return Value</b>	Always returns TRUE
<b>Usage</b>	BOOL    bRet = StopWDT()