

Neosys Technology Inc.

Nuvo-3100 Series

Intel® 3rd-Gen Core™ i7/i5 Fanless in-Vehicle Controller

Nuvo-3100VTC

Nuvo-3120

User's Manual

Rev. A1.4

Published Mar 19th, 2015



Date	Change List	Version
2014/08/08	- Specify that ignition control function of Nuvo-3120 is optional (page 10). - Remove E-mark from Nuvo-3120 certificate list (page 11).	A1.1
2014/09/24	- Change Nuvo-3100VTC bracket to damping version (page 53)	A1.2
2015/01/27	- Correct spell: protective film	A1.3
2015/03/19	- Add descriptions of new BIOS-configurable ignition function (section 3.7.3).	A1.4

Contents

Disclaimer.....	6
Declaration of Conformity	6
FCC	6
CE.....	6
Copyright and Trademarks	6
Chapter 1 Introduction	7
1.1 Overview.....	7
1.2 Product Specification.....	8
1.2.1 Specification of Nuvo-3100VTC.....	8
1.2.2 Specification of Nuvo-3120.....	9
1.2.3 Specification of Isolated DIO.....	11
1.3 Supported CPU List.....	12
Chapter 2 Getting to know your Nuvo-3100.....	13
2.1 Unpacking your Nuvo-3100 Series.....	13
2.2 Front Panel I/O Functions.....	15
2.2.1 Power Button	15
2.2.2 Reset Button	15
2.2.3 LED Indicators	16
2.2.4 WLAN/WWAN LED Indicators	16
2.2.5 USB 3.0 Connectors	17
2.2.6 Speaker-out and MIC-in Audio Jacks.....	17
2.2.7 DVI/HDMI Connectors.....	18
2.2.8 COM Ports (COM1 & COM2).....	19
2.2.9 Hot-Swappable HDD Tray (Nuvo-3100VTC Only)	20
2.3 Back Panel I/O Functions	21
2.3.1 3-Pin Terminal Block for DC Input & Ignition Input.....	21
2.3.2 IGN On/Off Delay Configuration Switch (Nuvo-3100VTC Only).....	22
2.3.3 DisplayPort Ports	23
2.3.4 USB 2.0 Connectors	24
2.3.5 Gigabit 802.3at PoE Ports (Nuvo-3100VTC).....	24
2.3.6 Gigabit Ethernet Ports (Nuvo-3120).....	25
2.3.7 Isolated DIO.....	26
2.4 Internal I/O Functions	28
2.4.1 DDR3 SODIMM Sockets.....	28
2.4.2 SATA Port for Internal HDD/SSD.....	29
2.4.3 SATA Port for HDD Tray (Nuvo-3100VTC Only).....	30
2.4.4 Full-Size Mini-PCIe Connector (with SIM Socket).....	31
2.4.5 Full-Size mSATA Connector (with SIM Socket)	32



2.4.6 Half-Size Mini-PCle Connector	33
2.5 Mechanical Dimension.....	34
2.5.1 Top View of Nuvo-3100VTC	34
2.5.2 Front View of Nuvo-3100VTC	35
2.5.3 Side View of Nuvo-3100VTC	35
2.5.4 Bottom View of Nuvo-3100VTC	36
2.5.5 Top View of Nuvo-3120.....	37
2.5.6 Front View of Nuvo-3120	38
2.5.7 Side View of Nuvo-3120.....	38
2.5.8 Bottom View of Nuvo-3120	39
Chapter 3 Getting Start.....	40
3.1 Install DDR3 SODIMM Modules	40
3.1.1 Install DDR3 SODIMM Module to Nuvo-3100VTC.....	40
3.1.2 Install DDR3 SODIMM Module to Nuvo-3120	41
3.2 Install 2.5" HDD/SSD	43
3.2.1 Install 2.5" HDD to Pet-Door of Nuvo-3100VTC.....	43
3.2.2 Install 2.5" HDD to hot-swappable HDD tray of Nuvo-3100VTC	45
3.2.3 Install 2.5" HDD to Pet-Door of Nuvo-3120	46
3.3 Install Mini-PCle Module.....	48
3.3.1 Install Mini-PCle Module to Nuvo-3100VTC.....	48
3.3.2 Install Mini-PCle Module to Nuvo-3120.....	52
3.4 Mount your Nuvo-3100 Series	56
3.4.1 Mount your Nuvo-3100VTC with Dedicated Damping Brackets.....	56
3.4.2 Mount your Nuvo-3120 on the Wall/Surface	57
3.4.3 Mount your Nuvo-3100 Series on the DIN Rail	59
3.5 Connect DC power to you Nuvo-3100 Series	60
3.6 Power on your Nuvo-3100 Series	61
3.6.1 Power on Nuvo-3100 Series Using the Power Button.....	61
3.6.2 Power on Nuvo-3100 Series Using External Latched Switch.....	61
3.6.3 Power on Nuvo-3100 Series Using Wake-on-LAN Function	62
3.7 Ignition Power Control (Nuvo-3100VTC Only)	66
3.7.1 Principle of Ignition Power Control	66
3.7.2 Wiring Ignition Signal	67
3.7.3 Operation Modes of Ignition Power Control	69
Chapter 4 BIOS and Driver	75
4.1 BIOS Settings	75
4.1.1 COM1 & COM2 Operating Mode	75
4.1.2 SATA Controller Mode for Nuvo-3100VTC	76
4.1.3 Configure Hot-Swappable HDD Tray of Nuvo-3100VTC.....	77
4.1.4 SATA Controller Mode for Nuvo-3120.....	78



4.1.5 Power On after Power Failure Option	79
4.1.6 W_DISABLE# for Mini-PCIe Sockets	80
4.1.7 System Operating Mode	81
4.1.8 Wake on LAN Option	82
4.1.9 Watchdog Timer for Booting	82
4.1.10 Select a Boot Device.....	84
4.2 Configure AMT (Nuvo-3100VTC Only)	85
4.3 Operating System Support.....	86
4.4 Driver Installation.....	87
4.4.1 Install All Drivers Using “One-Click” Driver Installation.....	87
4.4.2 Install Drivers Manually	88
Appendix A Using Watchdog Timer & Isolated DIO	90
Install WDT and DIO Library.....	91
Using WDT Function.....	93
WDT Function Reference.....	93
InitWDT	93
SetWDT	93
StartWDT	94
ResetWDT	94
StopWDT	94
Using DIO Function	95
Wiring for DIO	95
DIO Pin Definition	96
DIO Function Reference	97
InitDIO	97
DIReadLine	97
DIReadPort	97
DOWriteLine	98
DOWritePort	98
DOWriteLineChecked	99
DOWritePortChecked	99
Using COS Function	101
SetupDICOS	101
RegisterCallbackDICOS	102
StartDICOS	102
StopDICOS	103
DI COS Example.....	104



Disclaimer

This manual is intended to be used as a practical and informative guide only and is subject to change without prior notice. It does not represent commitment from Neousys Technology Inc. Neousys shall not be liable for direct, indirect, special, incidental, or consequential damages arising out of the use of the product or documentation, nor for any infringements upon the rights of third parties, which may result from such use.

Declaration of Conformity

FCC

This equipment has been tested and found to comply with the limits for a Class A digital device, pursuant to part 15 of the FCC Rules. These limits are designed to provide reasonable protection against harmful interference when the equipment is operated in a commercial environment. This equipment generates, uses, and can radiate radio frequency energy and, if not installed and used in accordance with the instruction manual, may cause harmful interference to radio communications. Operation of this equipment in a residential area is likely to cause harmful interference in which case the user will be required to correct the interference at his own expense.

CE

The product(s) described in this manual complies with all applicable European Union (CE) directives if it has a CE marking. For computer systems to remain CE compliant, only CE-compliant parts may be used. Maintaining CE compliance also requires proper cable and cabling techniques.

Copyright and Trademarks

This document contains proprietary information protected by copyright. All rights are reserved. No part of this document may be reproduced by any mechanical, electronic, or other means in any form without prior written permission of the manufacturer.

Company/product names mentioned herein are used for identification purposes only and are trademarks and/or registered trademarks of their respective companies.



Chapter 1 Introduction

1.1 Overview

Introducing the most compact in-vehicle fanless controller supporting PGA-type 3rd-Gen i7/i5 processor!

Neosys' Nuvo-3100 series features the dimension of only 212 mm x 165 mm x 62 mm. While other compact fanless controllers adopt low-voltage, BGA-type i7 CPU (17W TDP), Nuvo-3100 supports standard voltage, PGA-type i7/i5/i3 CPU for flexible CPU installation. To solve the trade-off between heat-sink size and operating temperature, a unique feature, configurable CPU power mode, is developed for Nuvo-3100 series. According to ambient condition, users can configure the system to operate in maximal performance, reduced performance or extended temperature mode.

Plenty of I/O functions, such as Gigabit Ethernet, USB 3.0, SATA, COM ports, mini-PCIe and isolation DIO are provided in Nuvo-3100's compact chassis. Nuvo-3100 series supports 8~35V DC input to be deployed in various environments.

As the designated model for in-vehicle applications, Nuvo-3100VTC further integrates IEEE 802.3at PoE, intelligent ignition power control and a hot-swappable HDD tray. It carries E-Mark to meet the requirements of European UN regulations for in-vehicle usage.



Nuvo-3100VTC



Nuvo-3120

1.2 Product Specification

1.2.1 Specification of Nuvo-3100VTC

System Core	
Processor	Supports the following CPU <ul style="list-style-type: none"> ● Intel® Core™ i7-3610QE (2.3/3.3 GHz, 6 MB cache) ● Intel® Core™ i5-3610ME (2.7/3.3 GHz, 3 MB cache) ● Intel® Celeron™ 1020E (2.2 GHz, 2 MB cache)
Chipset	Intel® QM77 Platform Controller Hub with AMT & RAID support
Graphics	Integrated Intel® HD Graphics 4000 Controller
Memory	1x 204-pin SO-DIMM sockets, up to 8 GB DDR3 1333/1600 MHz SDRAM
I/O Interface	
Ethernet	1x Gigabit Ethernet port by Intel® 82579LM, supporting Wake-on-LAN 3x Gigabit Ethernet ports by Intel® i210
PoE	Compliant to IEEE 802.3at (25.5W) with per-port power on/off control 75W total power budget for 4x PoE ports
Video Port	1x DVI-I connector for VGA/DVI output, supporting 2048x1536 (VGA) or 1920x1080 (DVI) resolution 2x DisplayPort, supporting 2560x1600 resolution
USB	4x USB 3.0 ports and 2x USB 2.0 ports
Serial Port	2x software-programmable RS-232/422/485 (COM1 & COM2)
Isolated DIO	4x isolated DI with COS interrupt and 4x isolated DO
Audio	1x mic-in and 1x speaker-out
Storage Interface	
SATA HDD	1x Internal SATA port for 2.5" HDD/SSD 1x Hot-swappable HDD tray for 2.5" HDD/SSD
mSATA	1x full-size mSATA (SATA/USB/W_DISABLE#) with USIM socket
Expansion Bus	
Mini PCI-E	1x full-size mini PCI Express socket with USIM socket 1x half-size mini PCI Express socket
Power Supply & Ignition Control	
DC Input	8~35V DC input via 3-pin pluggable terminal block
Ignition Control	Ignition power control with user-selectable on/off delay
Max. Power Consumption	With Core™ i7-3610QE: 68.8W (3.62A@19V)* With Core™ i5-3610ME: 46.9W (2.47A@19V)* With Celeron™ 1020E: 41.4W (2.18A@19V)*



Mechanical																	
Dimension	212 mm (W) x 165 mm (D) x 62 mm (H)																
Weight	2.8 Kg (including one 2.5" HDD and DDR3 SODIMM)																
Mounting	Wall-mounting (Standard) or DIN-Rail mounting (optional)																
Environmental																	
Operating Temperature	<table border="1"> <thead> <tr> <th></th> <th>i7-3610QE, 100% CPU loading*</th> <th>i5-3610ME, 100% CPU loading*</th> <th>Celeron 1020E, 100% CPU loading*</th> </tr> </thead> <tbody> <tr> <td>Maximal Performance</td> <td>-25°C ~ 50°C**</td> <td>-25°C ~ 60°C**</td> <td>-25°C ~ 70°C**</td> </tr> <tr> <td>Reduced Performance</td> <td>-25°C ~ 60°C**</td> <td>-25°C ~ 70°C**</td> <td>-25°C ~ 70°C**</td> </tr> <tr> <td>Extended Temperature</td> <td>-25°C ~ 70°C**</td> <td>-25°C ~ 70°C**</td> <td>-25°C ~ 70°C**</td> </tr> </tbody> </table>		i7-3610QE, 100% CPU loading*	i5-3610ME, 100% CPU loading*	Celeron 1020E, 100% CPU loading*	Maximal Performance	-25°C ~ 50°C**	-25°C ~ 60°C**	-25°C ~ 70°C**	Reduced Performance	-25°C ~ 60°C**	-25°C ~ 70°C**	-25°C ~ 70°C**	Extended Temperature	-25°C ~ 70°C**	-25°C ~ 70°C**	-25°C ~ 70°C**
		i7-3610QE, 100% CPU loading*	i5-3610ME, 100% CPU loading*	Celeron 1020E, 100% CPU loading*													
	Maximal Performance	-25°C ~ 50°C**	-25°C ~ 60°C**	-25°C ~ 70°C**													
	Reduced Performance	-25°C ~ 60°C**	-25°C ~ 70°C**	-25°C ~ 70°C**													
Extended Temperature	-25°C ~ 70°C**	-25°C ~ 70°C**	-25°C ~ 70°C**														
Storage Temperature	-40°C ~85°C																
Humidity	10%~90% , non-condensing																
Vibration	Operating, 5 Grms, 5-500 Hz, 3 Axes (w/ SSD, according to IEC60068-2-64)																
Shock	Operating, 50 Grms, Half-sine 11 ms Duration (w/ SSD, according to IEC60068-2-27)																
Certification	E-Mark for vehicle applications EN 50155 / EN 50121-3-2 CE/FCC Class A, according to EN 55022 & EN																

* The maximal power consumption is measured in Max. Performance Mode with 100% CPU loading applied using Passmark® BurnInTest™ v7.0. For detail testing criteria, please contact Neosys Technology

** For sub-zero operating temperature, a wide temperature HDD drive or Solid State Disk (SSD) is required.

1.2.2 Specification of Nuvo-3120

System Core	
Processor	Supports the following CPU <ul style="list-style-type: none"> ● Intel® Core™ i7-3610QE (2.3/3.3 GHz, 6 MB cache) ● Intel® Core™ i5-3610ME (2.7/3.3 GHz, 3 MB cache) ● Intel® Celeron™ 1020E (2.2 GHz, 2 MB cache)
Chipset	Intel® QM76 Platform Controller Hub
Graphics	Integrated Intel® HD Graphics 4000 Controller
Memory	1x 204-pin SO-DIMM sockets, up to 8 GB DDR3 1333/1600 MHz SDRAM
I/O Interface	
Ethernet	1x Gigabit Ethernet port by Intel® 82579LM, supporting Wake-on-LAN



	1x Gigabit Ethernet ports by Intel® i210			
Video Port	1x DVI-I connector for VGA/DVI output, supporting 2048x1536 (VGA) or 1920x1080 (DVI) resolution 2x DisplayPort, supporting 2560x1600 resolution			
USB	4x USB 3.0 ports and 2x USB 2.0 ports			
Serial Port	2x software-programmable RS-232/422/485 (COM1 & COM2)			
Isolated DIO	4x isolated DI with COS interrupt and 4x isolated DO			
Audio	1x mic-in and 1x speaker-out			
Storage Interface				
SATA HDD	1x Internal SATA port for 2.5" HDD/SSD			
mSATA	1x full-size mSATA (SATA/USB/W_DISABLE#) with USIM socket			
Expansion Bus				
Mini PCI-E	1x full-size mini PCI Express socket with USIM socket 1x half-size mini PCI Express socket			
Power Supply & Ignition Control				
DC Input	8~35V DC input via 3-pin pluggable terminal block			
Ignition Control	Ignition power control with user-selectable on/off delay (Optional)			
Max. Power Consumption	With Core™ i7-3610QE: 65.6W (3.45A@19V)* With Core™ i5-3610ME: 43.9W (2.31A@19V)* With Celeron™ 1020E: 38.5W (2.03A@19V)*			
Mechanical				
Dimension	212 mm (W) x 165 mm (D) x 62 mm (H)			
Weight	2.7 Kg (including one 2.5" HDD and DDR3 SODIMM)			
Mounting	Wall-mounting (Standard) or DIN-Rail mounting (optional)			
Environmental				
Operating Temperature		i7-3610QE, 100% CPU loading*	i5-3610ME, 100% CPU loading*	Celeron 1020E, 100% CPU loading*
	Maximal Performance	-25°C ~ 50°C**	-25°C ~ 60°C**	-25°C ~ 70°C**
	Reduced Performance	-25°C ~ 60°C**	-25°C ~ 70°C**	-25°C ~ 70°C**
	Extended Temperature	-25°C ~ 70°C**	-25°C ~ 70°C**	-25°C ~ 70°C**
Storage Temperature	-40°C ~85°C			
Humidity	10%~90% , non-condensing			
Vibration	Operating, 5 Grms, 5-500 Hz, 3 Axes (w/ SSD, according to IEC60068-2-64)			



Shock	Operating, 50 Grms, Half-sine 11 ms Duration (w/ SSD, according to IEC60068-2-27)
Certification	CE/FCC Class A, according to EN 55022 & EN

* The maximal power consumption is measured in Max. Performance Mode with 100% CPU loading applied using Passmark® BurnInTest™ v7.0. For detail testing criteria, please contact Neosys Technology

** For sub-zero operating temperature, a wide temperature HDD drive or Solid State Disk (SSD) is required.

1.2.3 Specification of Isolated DIO

Isolated Digital Input	
No. of Channel	4-CH Isolated Digital Input Channels
Logic Level	Logic High: 5 to 24V Logic Low: 0 to 1.5V
Isolated Voltage	2500 Vrms
Input Resistance	2.4kΩ
Operation Mode	Polling I/O, Change-of-State Interrupt
Isolated Digital Output	
No. of Channel	4-CH Isolated Digital Output Channels
Sink Current (per channel)	100 mA (sustained loading) 250 mA (peak loading)
Isolated Voltage	2500 Vrms
Operation Mode	Polling, Change-of-State Interrupt
Output Type	Power MOSFET + Analog Device iCoupler®
Operation Mode	Polling I/O and Change-of-State interrupt for DI



1.3 Supported CPU List

Nuvo-3100 series accepts a PGA-type Intel® 3rd-Gen i7/i5/3 processor via the PGA988 CPU socket. In addition to i7-3610QE, i5-3610ME and Celeron 1020E, you may also select other processor listed below according to your consideration of cost and performance.

- Intel® Core™ i7-3840QM Processor (8M Cache, up to 3.80 GHz)
- Intel® Core™ i7-3820QM Processor (8M Cache, up to 3.70 GHz)
- Intel® Core™ i7-3740QM Processor (6M Cache, up to 3.70 GHz)
- Intel® Core™ i7-3720QM Processor (6M Cache, up to 3.60 GHz)
- Intel® Core™ i7-3630QM Processor (6M Cache, up to 3.40 GHz)
- **Intel® Core™ i7-3612QE Processor (6M Cache, up to 3.10 GHz) ***
- Intel® Core™ i7-3610QM Processor (6M Cache, up to 3.30 GHz)
- **Intel® Core™ i7-3610QE Processor (6M Cache, up to 3.30 GHz) ***
- Intel® Core™ i7-3540M Processor (4M Cache, up to 3.70 GHz)
- Intel® Core™ i7-3520M Processor (4M Cache, up to 3.60 GHz)
- **Intel® Core™ i5-3610ME Processor (3M Cache, up to 3.30 GHz) ***
- Intel® Core™ i5-3380M Processor (3M Cache, up to 3.60 GHz)
- Intel® Core™ i5-3360M Processor (3M Cache, up to 3.50 GHz)
- Intel® Core™ i5-3340M Processor (3M Cache, up to 3.40 GHz)
- Intel® Core™ i5-3320M Processor (3M Cache, up to 3.30 GHz)
- Intel® Core™ i5-3230M Processor (3M Cache, up to 3.20 GHz)
- Intel® Core™ i5-3210M Processor (3M Cache, up to 3.10 GHz)
- **Intel® Core™ i3-3120ME Processor (3M Cache, 2.40 GHz) ***
- Intel® Core™ i3-3120M Processor (3M Cache, 2.50 GHz)
- Intel® Core™ i3-3110M Processor (3M Cache, 2.40 GHz)
- Intel® Celeron® Processor 1020M (2M Cache, 2.10 GHz)
- **Intel® Celeron® Processor 1020E (2M Cache, 2.20 GHz) ***
- Intel® Celeron® Processor 1000M (2M Cache, 1.80 GHz)

*The processors with * are listed in Intel® Embedded Roadmap and with a 7-year life cycle support (2013~2019).*



Chapter 2 Getting to know your Nuvo-3100

2.1 Unpacking your Nuvo-3100 Series

When you receive the package of Nuvo-3100 series, please check immediately if the package contains all the items listed in the following table. If any item is missing or damaged, please contact your local dealer or Neusys Technology for further assistance.

Nuvo-3100VTC

Item	Description	Qty
1	Nuvo-3100VTC fanless in-vehicle controller (According to the configuration you order, CPU/DDR3/HDD may be included. Please verify these items if necessary.)	1
2	Accessory box, which contains <ul style="list-style-type: none"> ● Neusys Drivers & Utilities DVD ● Damping bracket for in-vehicle deployment ● Shock-absorbing grommet ● DVI-to-VGA adapter ● 3-pin pluggable terminal block ● Key for hot-swappable HDD tray ● HDD thermal pad for 2.5" HDD/SSD (if HDD is not installed) ● Screw pack 	1 2 8 1 1 1 1 1

Nuvo-3120

Item	Description	Qty
1	Nuvo-3120 fanless in-vehicle controller (According to the configuration you order, CPU/DDR3/HDD may be included. Please verify these items if necessary.)	1
2	Accessory box, which contains <ul style="list-style-type: none"> ● Neusys Drivers & Utilities DVD ● Wall-mounting bracket ● DVI-to-VGA adapter ● 3-pin pluggable terminal block ● HDD thermal pad for 2.5" HDD/SSD (if HDD is not installed) 	1 2 1 1 1



	● Screw pack	1
--	--------------	---



2.2 Front Panel I/O Functions

On Nuvo-3100 series, plenty of I/O functions are provided on front panel and back panel so you can easily access them. Most common computer I/O functions are placed on the front panel. In this section, we'll illustrate each I/O function on the front panel.

2.2.1 Power Button



The power button is a non-latched switch for ATX mode on/off operation. To turn on the Nuvo-3100VTC/3120, press the power button and the PWR LED is lighted up. To turn off the Nuvo-3100VTC/3120, you can either issue a shutdown command in OS, or just simply press the power button. In case of system halts, you can press and hold the power button for 5 seconds to compulsorily shut down the system. Please note that a 5 seconds interval is kept by the system between two on/off operations (i.e. once turning off the system, you shall wait for 5 seconds to initiate another power-on operation).

2.2.2 Reset Button



The reset button is used to manually reset the system in case of any abnormal condition. To avoid unexpected operation, the reset button is hidden behind the front panel. You need to use a pin-like object to push the reset button.



2.2.3 LED Indicators



There are four LED indicators on the front panel: PWR, HDD, WDT and IGN. The descriptions of these four LEDs are listed in the following table.

Indicator	Color	Description
PWR	Green	Power indicator, lighted-up when system is on.
HDD	Red	Hard drive indicator, flashing when SATA HDD is active..
WDT	Yellow	Watchdog timer indicator, flashing when watchdog timer is started.
IGN	Green	Ignition signal indicator, lighted-up when IGN is high (12V/24V).

2.2.4 WLAN/WWAN LED Indicators



There are another three LED indicators on the front panel to present status of wireless communication. Per the specification of mini-PCIe, signals of LED_WLAN# and LED_WWAN# can be used by WIFI/3G module to indicate its communication status. These LEDs are connected to three mini-PCIe/mSATA (with SIM) slots respectively. Once LED_WLAN# or LED_WWAN# is de-asserted, the LED is lighted

Indicator	Color	Description
Left	Green	WLAN/WWAN LED Indicator for full-size mini-PCIe slot with SIM
Mid	Green	WLAN/WWAN LED Indicator for full-size mSATA slot with SIM

Right	Green	WLAN/WWAN LED Indicator for half-size mini-PCIe slot
-------	-------	--

2.2.5 USB 3.0 Connectors



Nuvo-3100 series offers four USB 3.0 (SuperSpeed USB) ports on its front panel. By BIOS default, these USB ports are operated in xHCI (eXtensible Host Controller Interface) mode and are compatible with USB 3.0, USB 2.0, USB 1.1 and USB 1.0 devices. Legacy USB support is also provided so you can use USB keyboard/mouse in DOS environment. To use USB 3.0 ports in Windows environment, you need to install corresponding USB 3.0 driver. Please refer to section 4.4 for information of driver installation.

Note

1. Intel USB 3.0 driver does not support Windows XP. In Windows XP, all USB 3.0 ports will work in USB 2.0 mode.

2.2.6 Speaker-out and MIC-in Audio Jacks



Nuvo-3100 series provides audio function using Intel® High Definition Audio (built-in in QM77/HM76 PCH) and Realtek ALC262 codec. There are two audio jacks on the front panel. The left one is used for microphone input, and the right one is used for speaker output. To utilize the audio function in Windows, you need to install corresponding drivers for both Intel® HM76 PCH chipset and Realtek ALC262 codec. Please refer to section 4.4 for information of driver installation.



2.2.7 DVI/HDMI Connectors



Nuvo-3100 series supports triple independent display outputs via a DVI-I/HDMI connector (front panel) and two DisplayPort connectors (back panel). The DVI-I connector on the front panel offers DVI/HDMI and VGA display outputs. The DVI/HDMI output can be either DVI signals or HDMI signal depending on the display device connected and support up to 1920 x 1080 resolution. The VGA output supports up to 2048x1536 resolution.

For VGA monitor, Neosys offers a dedicated DVI-to-VGA adapter as an accessory shipped with Nuvo-3100 series. This adapter supports VGA DDC signals and thus eliminates compatibility issues with VGA monitors. Or you can use a DVI-I to VGA+DVI-D Y-cable to support two independent display outputs.



DVI-to-VGA Adapter



DVI-I to VGA+DVI-D Y-Cable

Due to the limitation of Intel® QM77/HM76 PCH, the feature of triple independent display outputs is only available via the configuration of DVI+DisplayPort+DisplayPort or VGA+DisplayPort+DisplayPort. You also need to install corresponding graphics driver for Windows XP/7/8 to enable this feature. Please refer to section 4.4 for information regarding driver installation.

Note

If you want to connect to a VGA monitor via DVI-I connector, please use the DVI-to-VGA adapter shipped with Nuvo-3100 series. Some off-the-shelf DVI-to-VGA adapters may have incompatible pin definition and cause compatibility issue with DVI-I output of Nuvo-3100 series.

2.2.8 COM Ports (COM1 & COM2)



Nuvo-3100 series provides two COM ports via two 9-pin D-Sub male connectors on the front panel for communicating with external devices. They are implemented using industrial-grade ITE8783 Super IO chip (-40 to 85°C) and provide up to 115200 bps baud rate.

Both COM1 and COM2 support software-selectable RS-232/422/485 mode. The operation mode of COM1/COM2 can be set in BIOS setup utility (refer to section 4.1.1 for detail). The following table describes the pin definition of COM ports.

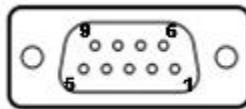

Pin#	RS-232 Mode	RS-422 Mode	RS-485 Mode (Two-wire 485)
1	DCD		
2	RX	422 TXD+	485 TXD+/RXD+
3	TX	422 RXD+	
4	DTR	422 RXD-	
5	GND	GND	GND
6	DSR		
7	RTS		
8	CTS	422 TXD-	485 TXD-/RXD-
9	RI		

2.2.9 Hot-Swappable HDD Tray (Nuvo-3100VTC Only)



Nuvo-3100VTC supports the second 2.5" HDD in the accommodation of a hot-swappable HDD tray. This HDD tray comes with a locking mechanism to secure the HDD installed. Please refer to section 3.2.2 for information regarding installing a HDD to the hot-swappable HDD tray.

This HDD tray supports hot-swap operation for storage portability, as well as fixed mode for OS installation or RAID 0/1 operation with the first HDD. You can configure the operation mode of this SATA port in BIOS. Please refer to section 4.1.2/4.1.3 for further information.

2.3 Back Panel I/O Functions

To fit more general application requirements, Nuvo-3100 series offers more I/O functions on its back panel. In this section, we'll illustrate each I/O function on the back panel.

2.3.1 3-Pin Terminal Block for DC Input & Ignition Input



Nuvo-3100 series allows a wide range of DC power input from 8 to 35V via a 3-pin pluggable terminal block. It is fit for field usage where DC power is usually provided and its screw clamping connection of terminal block gives a very reliable way of wiring the DC power. For detail information of supplying DC power via pluggable terminal block, please refer to section 3.5.

In addition to DC power input, this terminal block is also used for ignition signal input for in-vehicle applications. For detail information of ignition power control, please refer to section 3.7.

Pin	Description	Example when deployed in vehicle
V+	Positive polarity of DC power input.	Connected to car battery (12V/24V)
GND	Ground of DC power input.	Connected battery GND
IGN	Ignition signal input.	Connected to ACC power of vehicle

Caution

1. Please make sure the voltage of DC power is correct before you connect it to Nuvo-3100VTC/3120. Supplying a voltage over 35V will damage the system.
2. The IGN input accepts ACC power of car (12VDC) or bus/truck (24VDC). Supply a voltage over 35V to IGN input to will damage the system.

2.3.2 IGN On/Off Delay Configuration Switch (Nuvo-3100VTC Only)

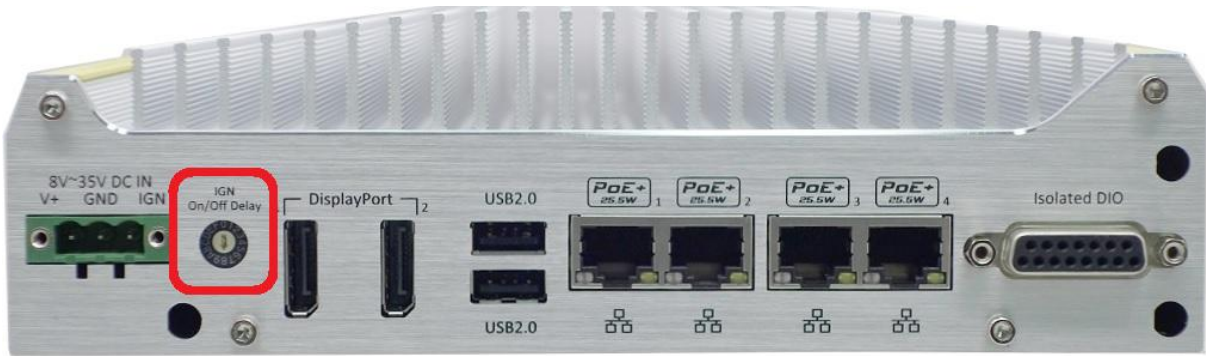

Nuvo-3100VTC features intelligent ignition power control with user-configurable power on/off delay. The IGN on/off delay configuration switch on the back panel allows users to adjust duration of power-on delay and power-off delay per application's requirement. A total of 8 modes are available for Rev. A1 (S/N from E2500000 to E2500100) and a total of 16 modes are available for Rev. A2. Please refer to section 3.7 for more information regarding ignition power control.

IGN On/Off Delay Configuration for Nuvo-3100VTC Rev. A1

Mode	Power-on Delay	Power-off Delay	Hard-off Timeout
0	ATX mode		
1	AT mode (power on after power supplied)		
2	10 seconds	10 seconds	10 minutes
3	30 seconds	1 minute	10 minutes
4	30 seconds	5 minutes	10 minutes
5	30 seconds	30 minutes	10 minutes
6	30 seconds	2 hours	10 minutes
7	30 seconds	5 hours	10 minutes

IGN On/Off Delay Configuration for Nuvo-3100VTC Rev. A2

Mode	Power-on Delay	Power-off Delay	Hard-off Timeout
0	ATX mode		
1	AT mode (power on after power supplied)		
2	Remote On/Off control mode (available for both Nuvo-3100VTC & Nuvo-3120)		
3	10 seconds	10 seconds	10 minutes
4	10 seconds	1 minute	10 minutes

5	10 seconds	5 minutes	10 minutes
6	30 seconds	1 minute	10 minutes
7	30 seconds	5 minutes	10 minutes
8	30 seconds	10 minutes	10 minutes
9	3 minutes	1 minute	10 minutes
A	3 minutes	10 minutes	10 minutes
B	3 minutes	30 minutes	10 minutes
C	10 minutes	30 minutes	10 minutes
D	30 seconds	2 hours	10 minutes
E	3 minutes	2 hours	10 minutes
F	30 seconds	5 hours	10 minutes

2.3.3 DisplayPort Ports



Nuvo-3100 series supports triple independent display outputs via a DVI-I/HDMI connector (front panel) and two DisplayPort connectors (back panel). The DisplayPort connectors on the back panel support up to 2560 x 1600 resolution.

Due to the limitation of Intel® QM77/HM76 PCH, the feature of triple independent display outputs is only available via the configuration of DVI+DisplayPort+DisplayPort or VGA+DisplayPort+DisplayPort. You also need to install corresponding graphics driver for Windows XP/7/8 to enable this feature. Please refer to section 4.4 for information regarding driver installation.

2.3.4 USB 2.0 Connectors



In addition to four USB 3.0 ports, Nuvo-3100 series provides another two USB 2.0 ports on the back panel. By BIOS default, these USB 2.0 ports are operated in EHCI (Enhanced Host Control Interface) mode and are compatible with USB 2.0, USB 1.1 and USB 1.0 devices. Legacy USB support is provided so you can use USB keyboard/mouse in DOS environment.

2.3.5 Gigabit 802.3at PoE Ports (Nuvo-3100VTC)



PoE, or Power over Ethernet, is a technology to supply electrical power along with data on a standard CAT-5/CAT-6 Ethernet cable. Nuvo-3100VTC, acting as a PoE PSE (Power Sourcing Equipment), integrates four GigE PoE ports compliant with IEEE 802.3at standard. Each PoE port can deliver 25.5 W of power to a PoE PD (Powered Device), such as a PoE IP camera. PoE defines a mechanism to automatically detect the device connected and determine whether to dispatch power. This makes PoE port 100% compatible with traditional Ethernet devices.

Four GigE PoE ports are located on the back panel. The first PoE port is implemented using Intel® 82579LM and the rest three PoE ports are implemented using Intel® I210 Gigabit Ethernet controllers. Each port has one dedicated GigE controller and one dedicated PCI Express link to present maximal network performance. When plugging in the

Ethernet cable, you can tell the Ethernet status and speed from the LED indicators on the RJ45 connector as following:

Active/Link LED

LED Color	Status	Description
Yellow	Off	Ethernet port is disconnected
	On	Ethernet port is connected and no data transmission
	Flashing	Ethernet port is connected and data is transmitting/receiving

Speed LED

LED Color	Status	Description
Green or Orange	Off	10 Mbps
	Green	100 Mbps
	Orange	1000 Mbps

The first GigE PoE port, which is implemented using Intel® 82579LM, supports Wake-on-LAN function. It is also capable of operating with Intel® AMT (Active Management Technology) to support advanced features such remote SOL desktop and remote on/off control. Please refer to section 4.2 for information of configuring AMT, and section 4.4 for information of driver installation for Windows XP/7/8.

2.3.6 Gigabit Ethernet Ports (Nuvo-3120)



Nuvo-3120 controller offers two Gigabit Ethernet ports located on the back panel. The first GbE port is implemented by Intel® 82579LM and the second GbE port is implemented using Intel® I210 Gigabit Ethernet controllers. Each port has one dedicated PCI Express link to present maximal network performance. When plugging in the Ethernet cable, you can tell the Ethernet status and speed from the LED indicators on the RJ45 connector as following:

Active/Link LED

LED Color	Status	Description
Yellow	Off	Ethernet port is disconnected
	On	Ethernet port is connected and no data transmission
	Flashing	Ethernet port is connected and data is transmitting/receiving

Speed LED

LED Color	Status	Description
Green or Orange	Off	10 Mbps
	Green	100 Mbps
	Orange	1000 Mbps

The first GigE PoE port, which is implemented using Intel® 82579LM, supports Wake-on-LAN function. Please refer to section 3.6.3 for information of using Wake-on-LAN, and section 4.4 for information of driver installation for Windows XP/7/8.

2.3.7 Isolated DIO



Nuvo-3100 series provides 4x isolated digital input channels and 4x isolated digital output channels. DIO function on Nuvo-3100 series supports polling mode I/O access and DI Change-of-State interrupt. Please refer to **Appendix A Using Watchdog Timer & Isolated DIO** for information about wiring and programming the isolated DIO channels.

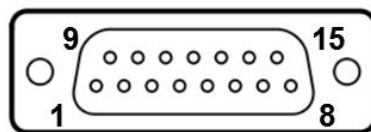

Pin#	Pin Definition	Pin#	Pin Definition
1	DI_0	9	DI_GND
2	DI_1	10	DI_2
3	DI_GND	11	DI_3
4	DO_GND	12	DO_GND
5	DO_0	13	DO_2
6	DO_1	14	DO_3
7	DO_GND	15	ISO_5V

8	VDD		
---	-----	--	--



2.4 Internal I/O Functions

In addition to I/O connectors on the front/back panel, Nuvo-3100 series provides other useful features via its on-board connectors, such as SATA ports, mini-PCIe sockets, internal USB ports, optional COM ports and etc. In this section, we'll illustrate these internal I/O functions.

2.4.1 DDR3 SODIMM Sockets

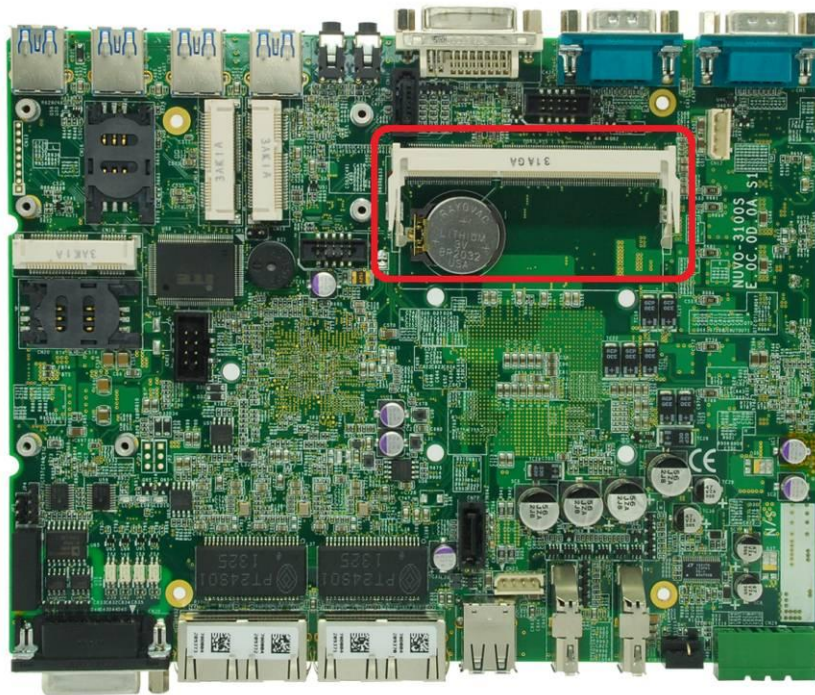

Nuvo-3100 series provides a 204-pin, SODIMM socket for installing DDR3 memory module. It supports up to 8GB DDR3 1600MHz SODIMM module. For information of installing DDR3 memory modules, please refer to section 3.1 for detail.

2.4.2 SATA Port for Internal HDD/SSD

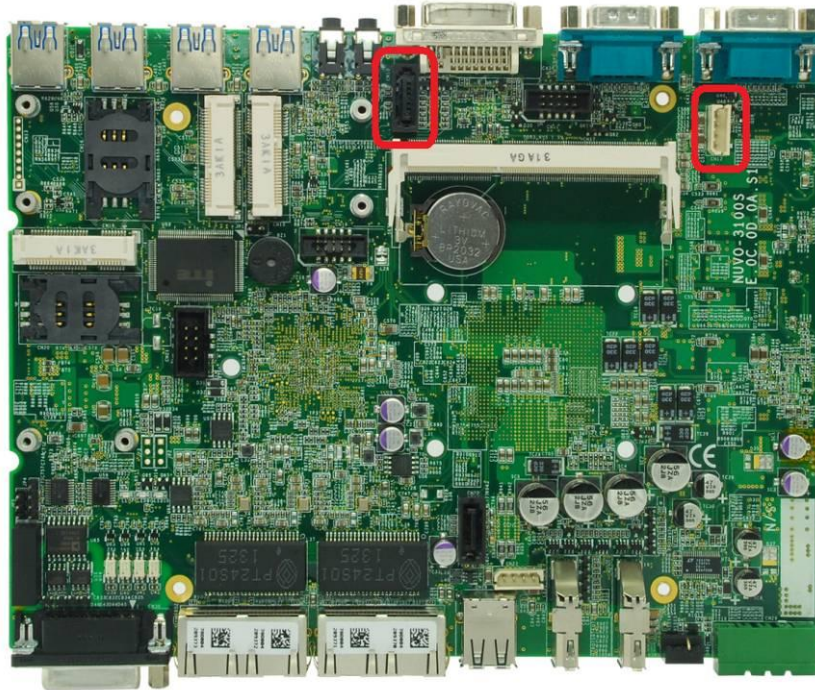

Nuvo-3100 series provides internal SATA ports to accommodate SATA hard drives. Each SATA port is composed of a 7-pin SATA connector and a 4-pin power connector. SATA#1 Port is used in conjunction with the HDD bracket on “Pet-Door” to accommodate a 2.5” HDD/SSD. A dedicated cable is assembled inside Nuvo-3100VTC/3120 to connect SATA#1 port and HDD/SSD. For information of installing a HDD/SSD to SATA#1 port, please refer to section 3.2 for detail.

2.4.3 SATA Port for HDD Tray (Nuvo-3100VTC Only)

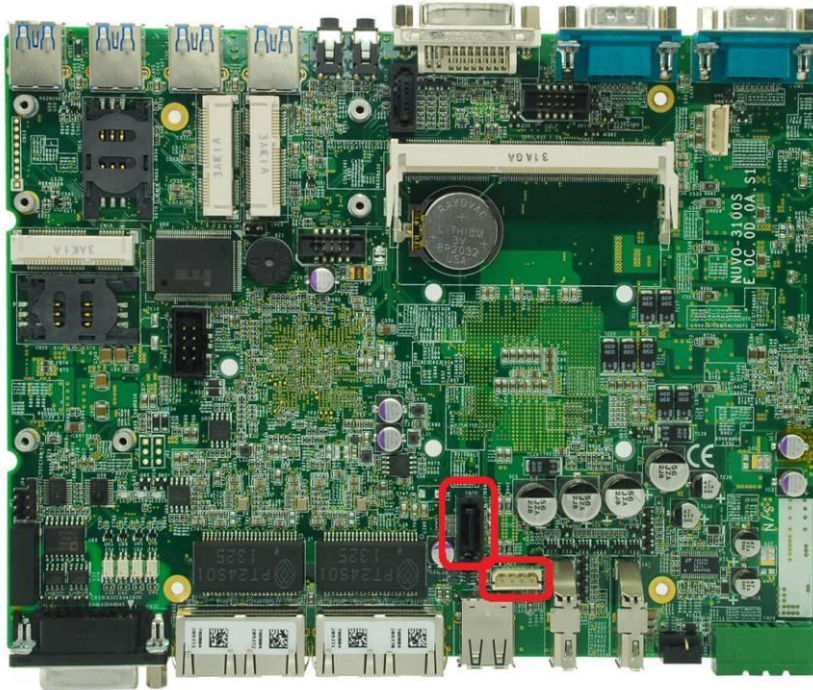

Nuvo-3100 series provides internal SATA ports to accommodate SATA hard drives. Each SATA port is composed of a 7-pin SATA connector and a 4-pin power connector. SATA#2 Port is assembled and connected to the hot-swappable HDD tray of Nuvo-3100VTC. For information of accessing the hot-swappable HDD tray, please refer to section 3.2.2 for detail.

2.4.4 Full-Size Mini-PCle Connector (with SIM Socket)

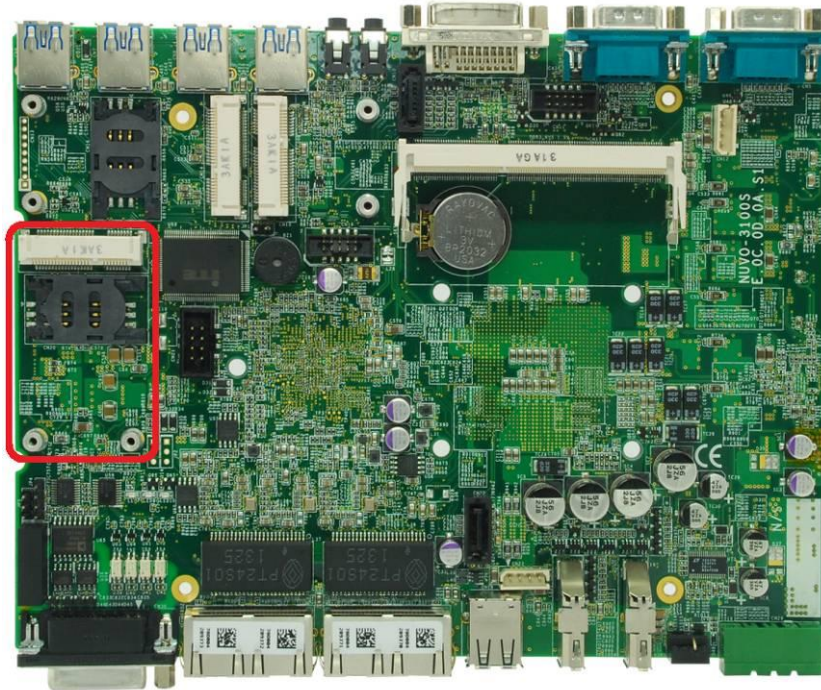

Nuvo-3100 series provides three on-board mini-PCle/mSATA connectors. The full-size mini-PCle connector is come with x1 PCI Express and USB signals, as well as a SIM socket support. It is designed for installing off-the-shelf LTE/3G/GPRS/GPS module. With a SIM card installed, it's capable to connect your system to Internet in wide territory through telecom operator's GPRS/3G network. A dedicated LED indicator on front panel presents the status of wireless communication for this full-size mini-PCle socket.



Nuvo-3100 series also provides multiple SMA antenna apertures on the back panel for antenna installation.



2.4.5 Full-Size mSATA Connector (with SIM Socket)

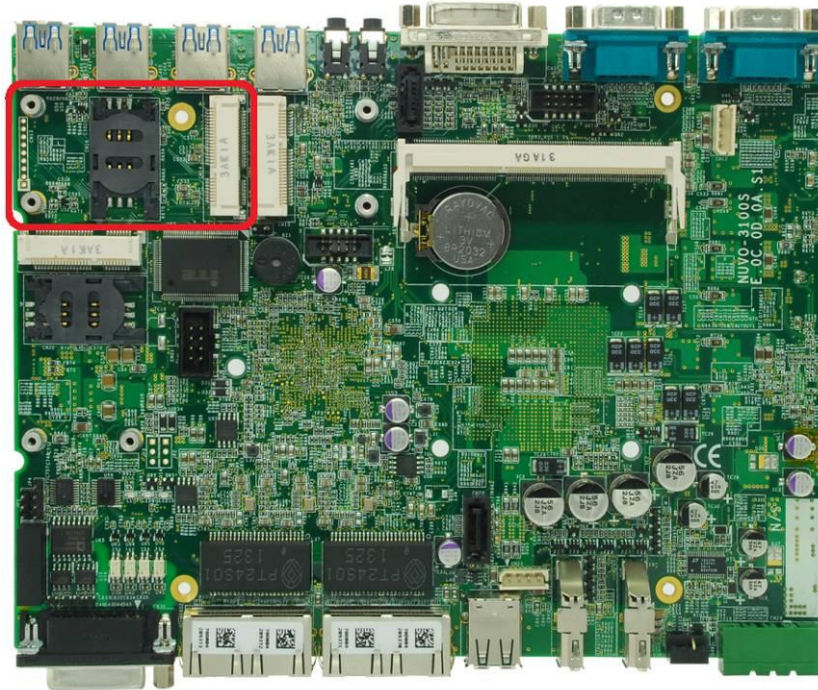

Nuvo-3100 series provides three on-board mini-PCIe/mSATA connectors. The full-size mSATA connector is come with mSATA and USB signals, as well as a SIM socket support. In addition to mSATA SSD, you can also install a 3G/GPRS/GPS module to this connector as most off-the-shelf 3G/GPRS/GPS modules require USB connectivity only. With the SIM support, it's capable to connect your system to Internet in wide territory through telecom operator's GPRS/3G network. A dedicated LED indicator on front panel presents the status of wireless communication for this full-size mSATA socket.



Nuvo-3100 series also provides multiple SMA antenna apertures on the back panel for antenna installation.



2.4.6 Half-Size Mini-PCIe Connector

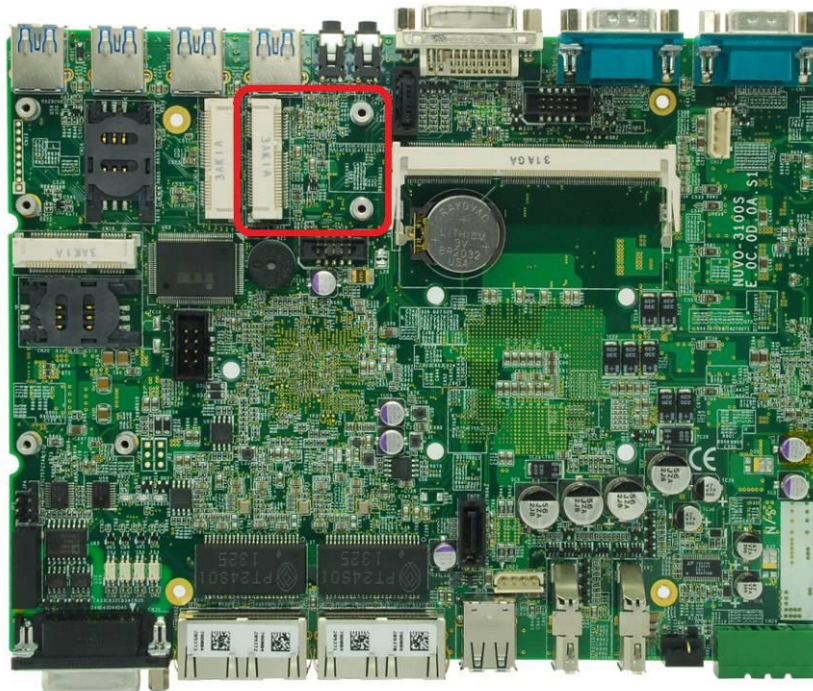

Nuvo-3100 series provides three on-board mini-PCIe/mSATA connectors. The half-size mini-PCIe connector is come with x1 PCI Express and USB signals. It is designed to work with a mini-PCIe WIFI module as the majority of WIFI modules are in half-size form-factor. A dedicated LED indicator on front panel presents the status of wireless communication for this half-size min-PCIe socket.



Nuvo-3100 series also provides multiple SMA antenna apertures on the back panel for antenna installation.



2.5 Mechanical Dimension

2.5.1 Top View of Nuvo-3100VTC

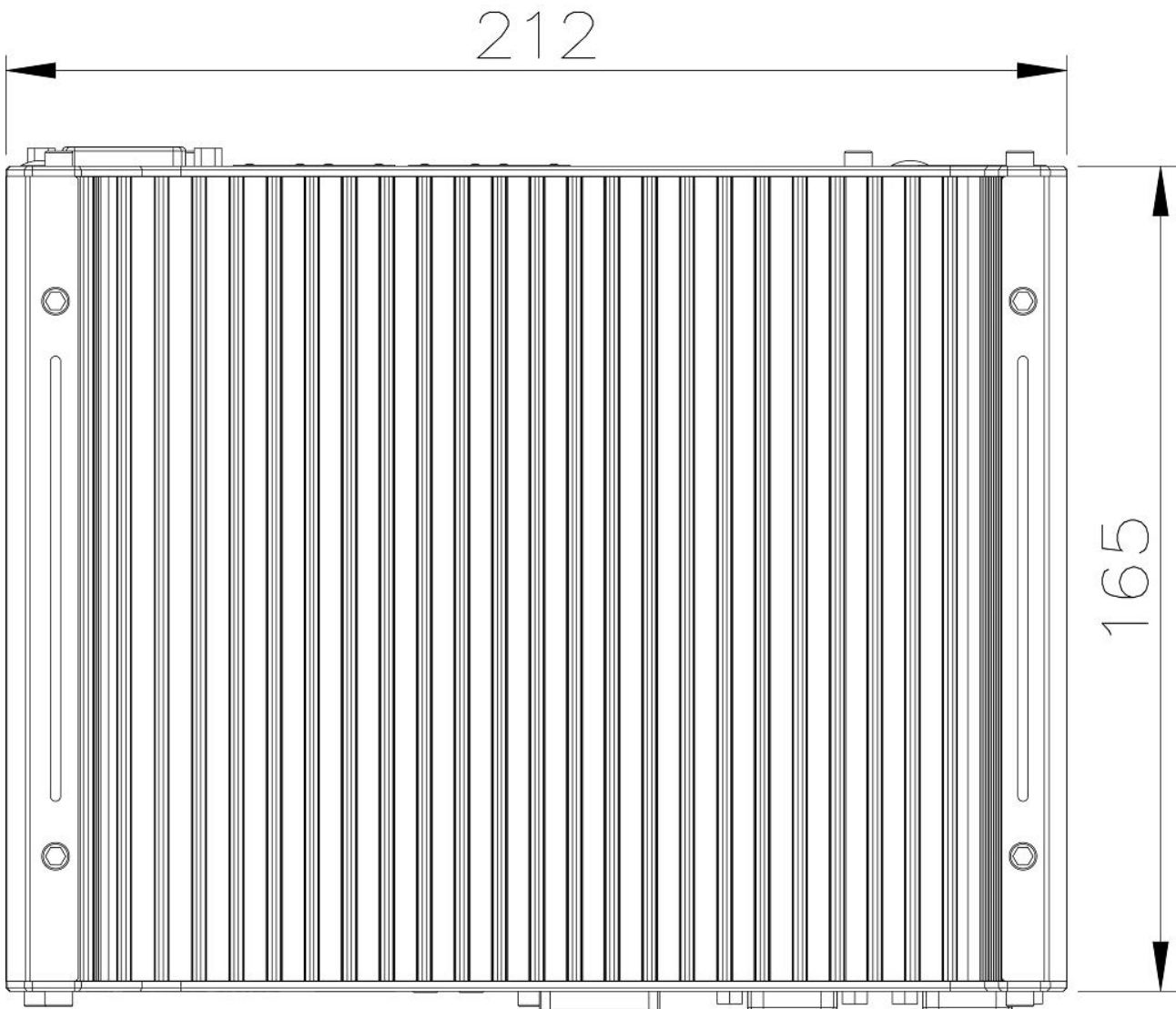

2.5.2 Front View of Nuvo-3100VTC

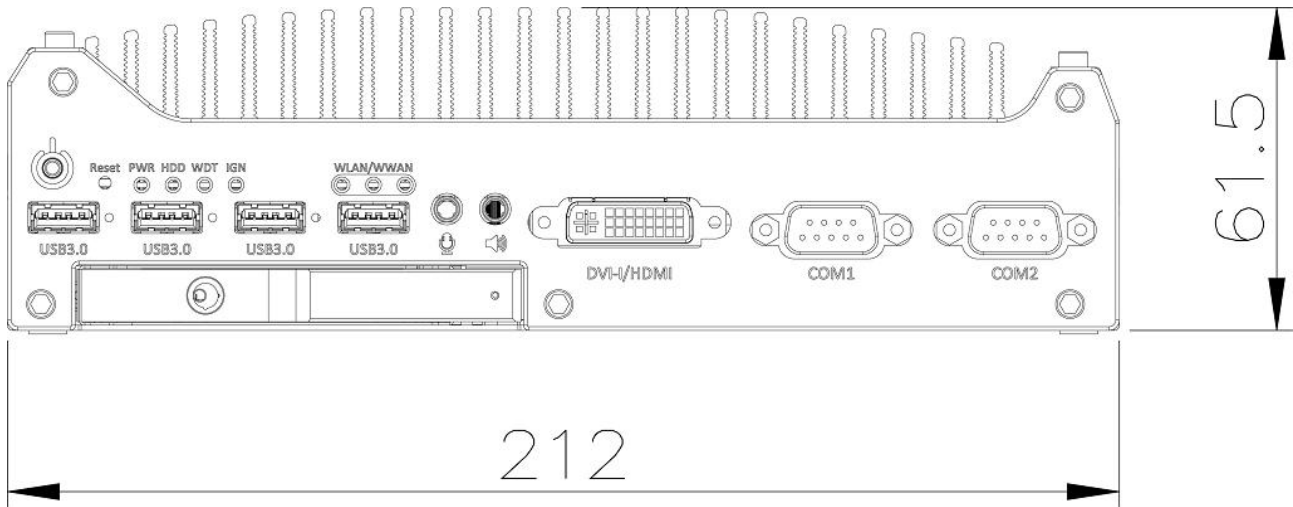

2.5.3 Side View of Nuvo-3100VTC

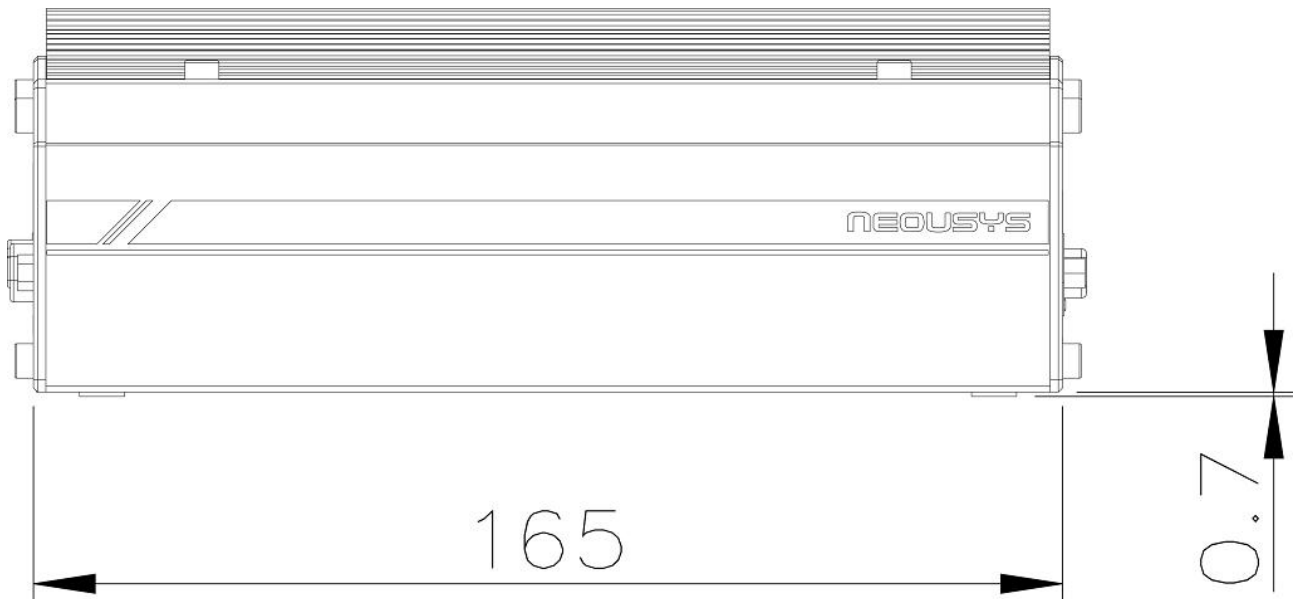

2.5.4 Bottom View of Nuvo-3100VTC

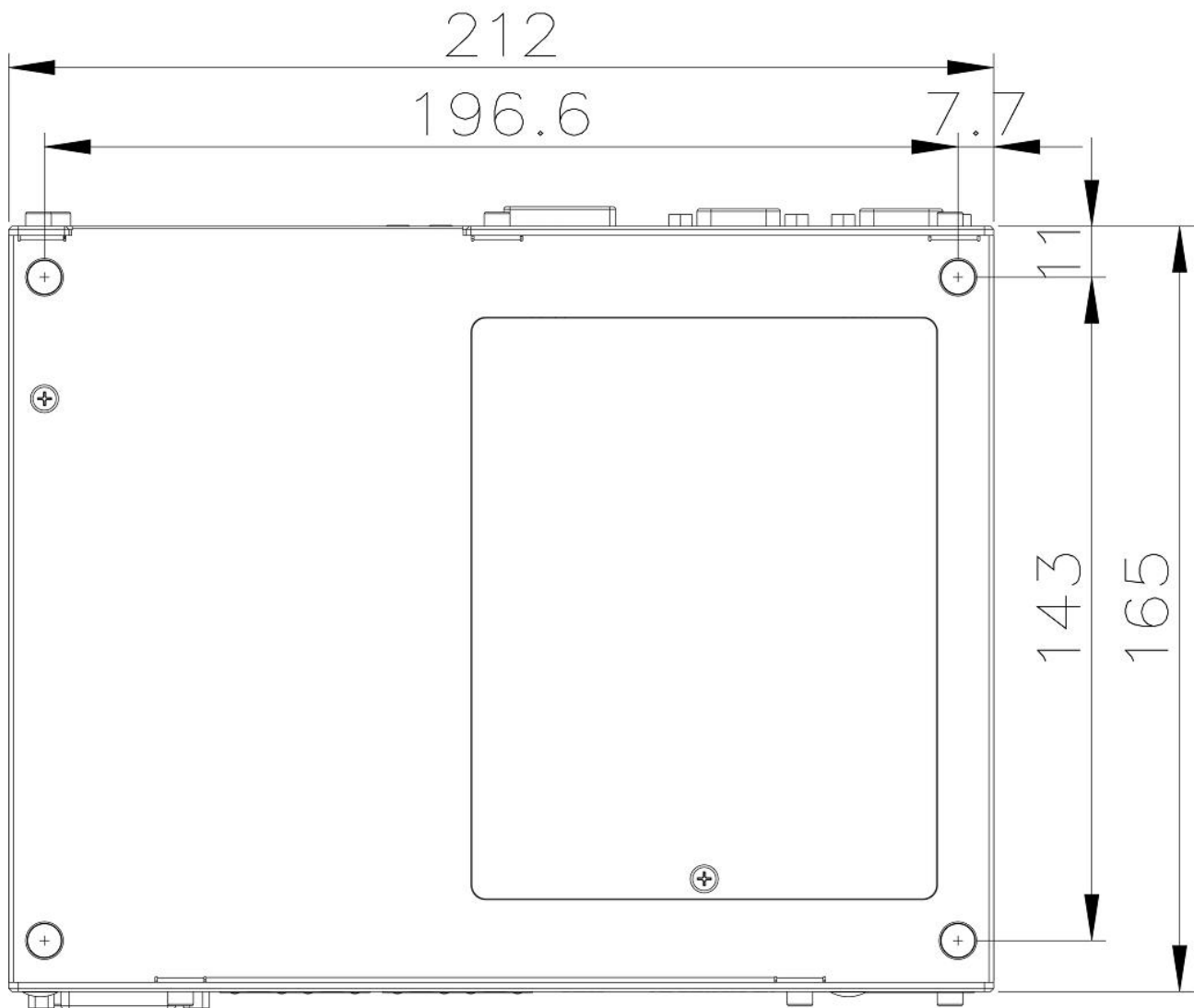

2.5.5 Top View of Nuvo-3120

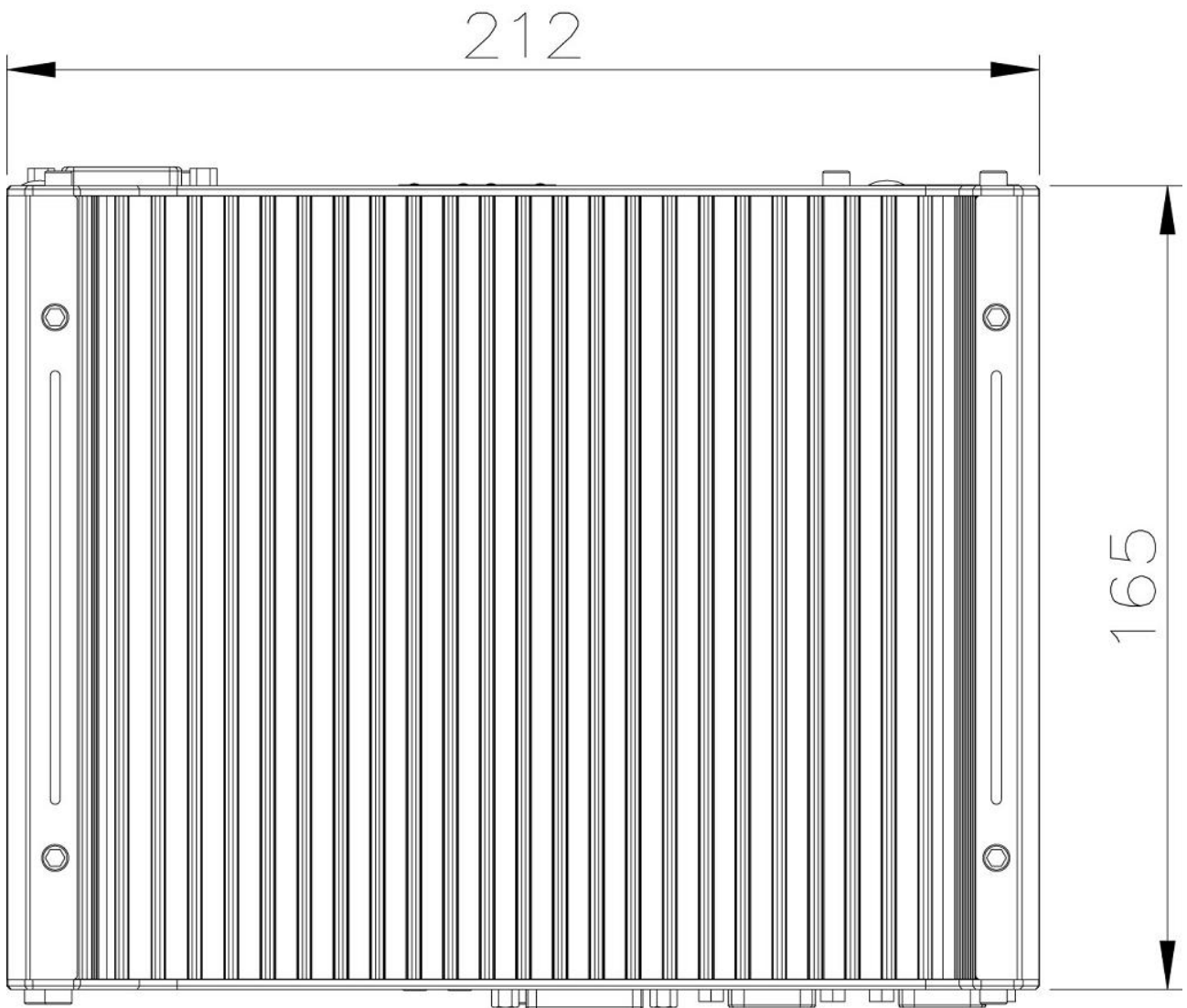

2.5.6 Front View of Nuvo-3120

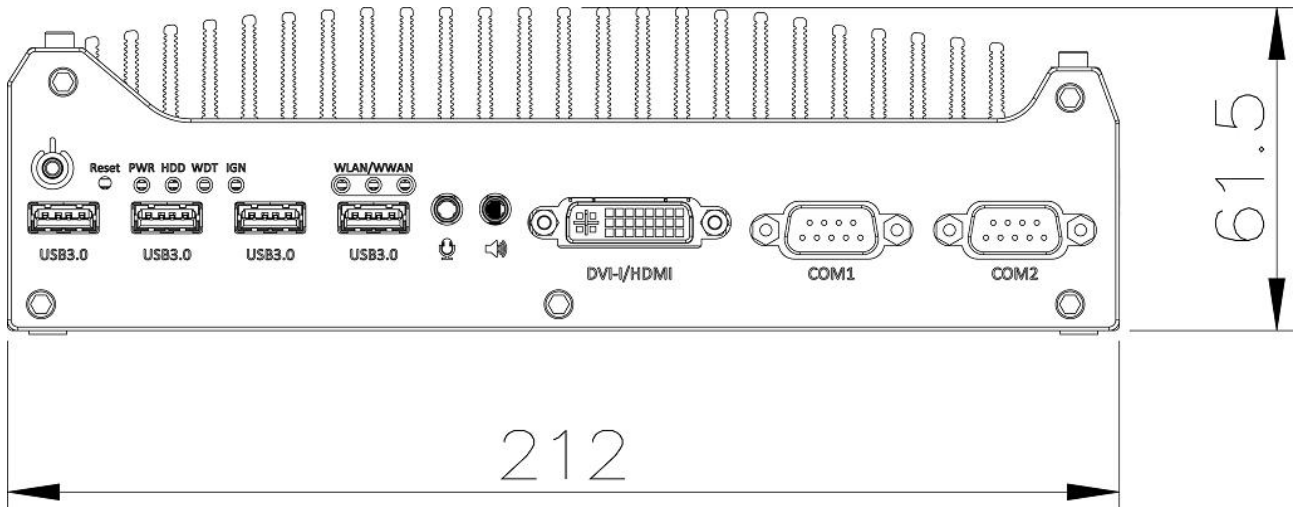

2.5.7 Side View of Nuvo-3120

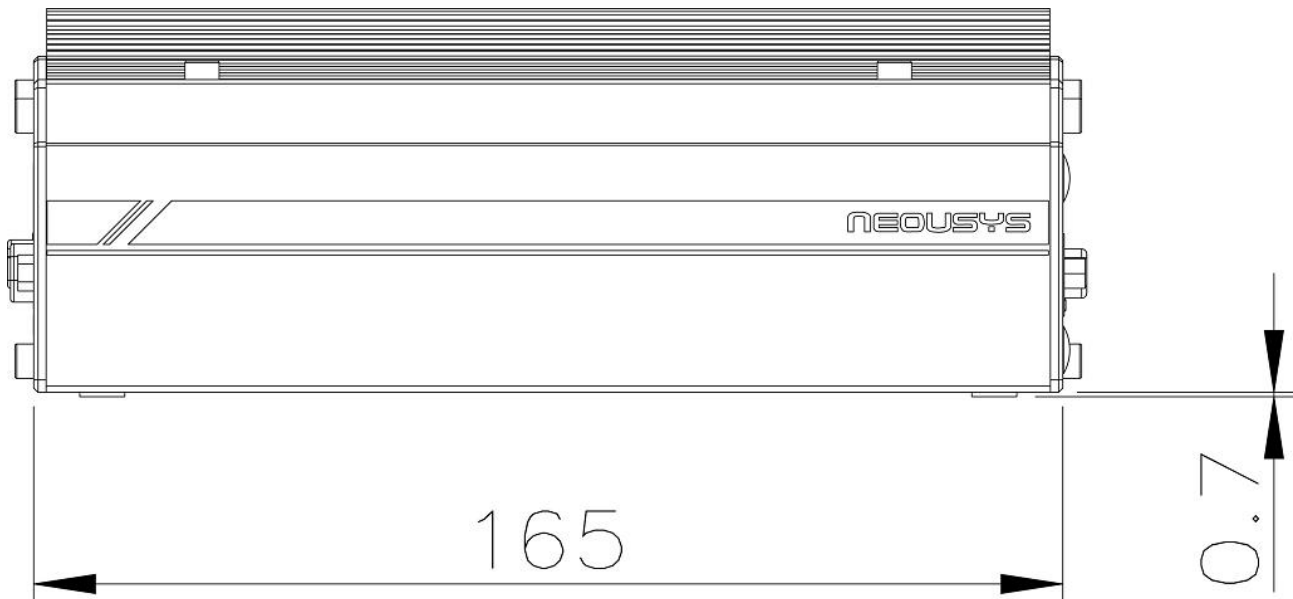

2.5.8 Bottom View of Nuvo-3120

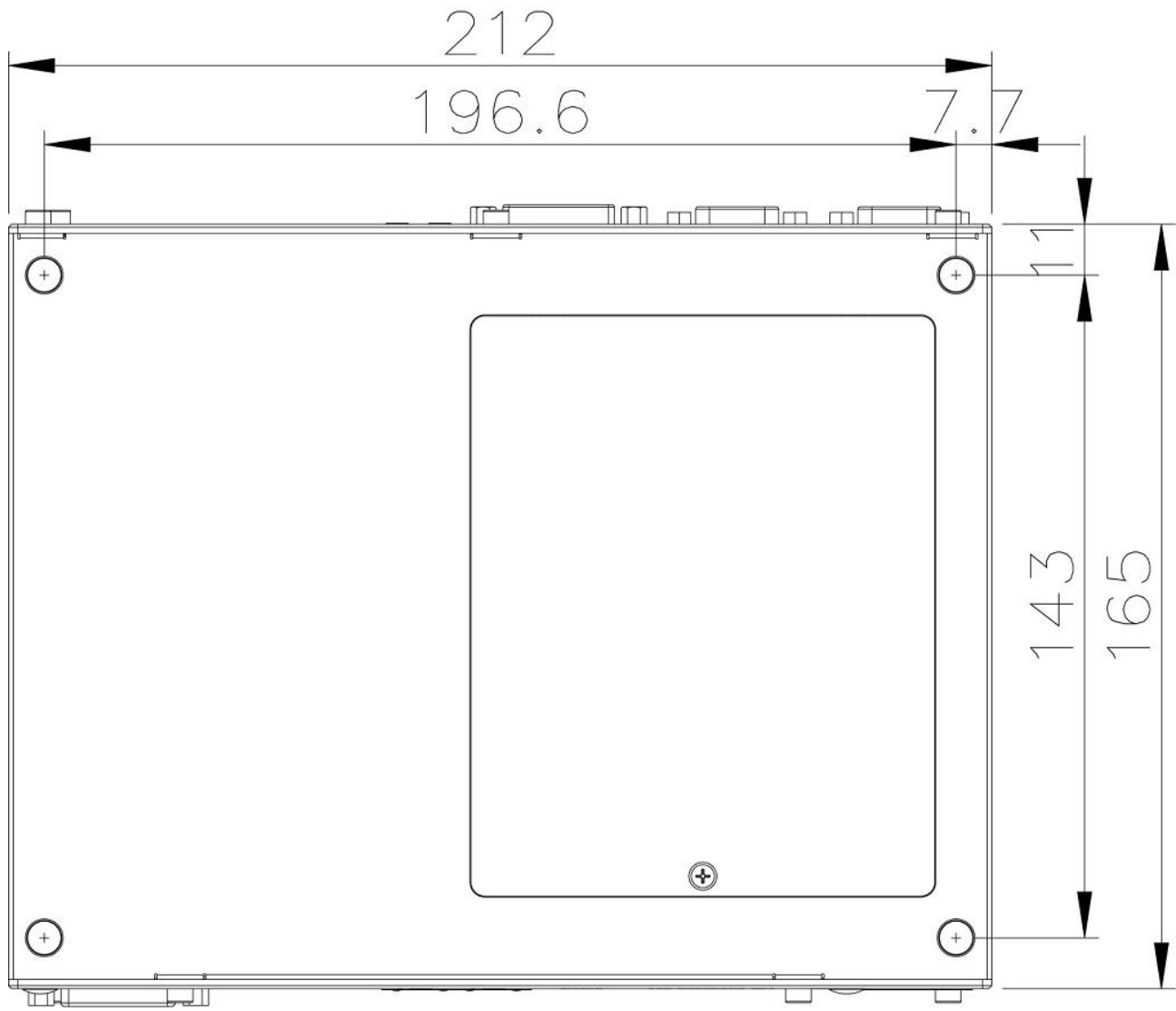

Chapter 3 Getting Start

3.1 Install DDR3 SODIMM Modules

Nuvo-3100 series provides one 204-pin, SODIMM socket for installing DDR3 memory module. It supports a maximal 8GB capacity by installing one 8GB DDR3 1600MHz SODIMM module. You can install/replace DDR3 SODIMM modules by following the steps listed below.

3.1.1 Install DDR3 SODIMM Module to Nuvo-3100VTC

1. Put the Nuvo-3100VTC upside down on a flat surface. You can see the “Pet-Door” exposed. Use a Philips screwdriver to loosen the M3 flat-head screw and open it.



2. When the “Pet-Door” of Nuvo-3100VTC opened, you can see the DDR3 204-pin SODIMM socket.



3. Tile the SODIMM module and insert it to the SODIMM socket. As it's firmly contacted with socket connector, press it down until the clamps of the socket snap into the latching position of SODIMM module.



4. Tilt the HDD assembly and insert the wedge of HDD bracket to the bottom cover. Once it's firmly wedged, push it down and fix it using a M3 flat-head screw.

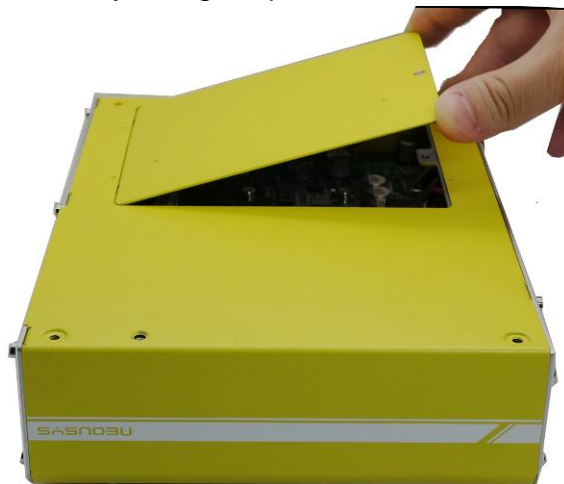

3.1.2 Install DDR3 SODIMM Module to Nuvo-3120

1. Put the Nuvo-3120 upside down on a flat surface. You can see the "Pet-Door" exposed. Use a Philips screwdriver to loosen the M3 flat-head screw and open it.



- When the “Pet-Door” of Nuvo-3120 opened, you can see the DDR3 204-pin SODIMM socket.



- Tile the SODIMM module and insert it to the SODIMM socket. As it's firmly contacted with socket connector, press it down until the clamps of the socket snap into the latching position of SODIMM module.



- Tilt the HDD assembly and insert the wedge of HDD bracket to the bottom cover. Once it's firmly wedged, push it down and fix it using a M3 flat-head screw.



3.2 Install 2.5" HDD/SSD

One Internal SATA port on Nuvo-3100 is used in conjunction with the HDD bracket on "Pet-Door" to accommodate a 2.5" HDD/SSD. The other is a 2.5" hot-swappable HDD tray which provide and convenient storage access and robust data integrity. You can install/replace the HDD/SSD attached to SATA port by following the steps listed below.

3.2.1 Install 2.5" HDD to Pet-Door of Nuvo-3100VTC

1. Put the Nuvo-3100VTC upside down on a flat surface. You can see the "Pet-Door" along with HDD bracket exposed. Use a Philips screwdriver to loosen the M3 flat-head screw and open it.



2. Get the HDD thermal pad from the accessory box. Remove the protective films (two sides) and place it on the HDD bracket.



Place the HDD into the bracket and gently push it down to make it firmly attach to the thermal pad. Use a Philips screwdriver to fix the HDD with M3 flat-head screws. Please note that the HDD must be placed in the right direction as below.



(another 2 screws are on the opposite side)

3. Pull out the SATA cable inside the chassis and connect it to HDD



4. Tilt the HDD assembly and insert the wedge of HDD bracket to the bottom cover. Once it's firmly wedged, push it down and fix it using a M3 flat-head screw.

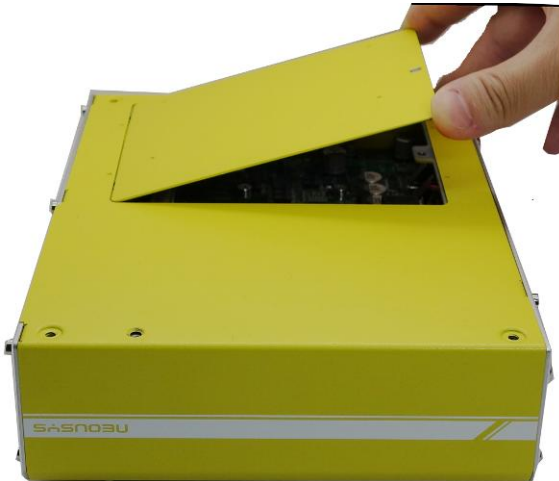

3.2.2 Install 2.5" HDD to hot-swappable HDD tray of Nuvo-3100VTC

1. Find the hot-swappable HDD tray door on the front panel of Nuvo-3100VTC.



2. Get the key for the hot-swappable HDD tray door from the accessory box and unlock it.



3. Pull the handle of the tray door to open the hot-swappable HDD tray.



4. Insert the 2.5" HDD into the hot-swappable HDD tray, and please note the HDD direction when you install it.



5. Push the handle back to the HDD tray along with the 2.5" HDD till it snaps into the latching position.



6. Use the key to lock the HDD tray door and secure the HDD.

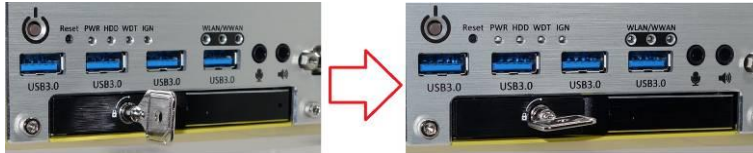

3.2.3 Install 2.5” HDD to Pet-Door of Nuvo-3120

1. Put the Nuvo-3120 upside down on a flat surface. You can see the “Pet-Door” along with HDD bracket exposed. Use a Philips screwdriver to loosen the M3 flat-head screw and open it.



2. Get the HDD thermal pad from the accessory box. Remove the protective films (two sides) and place it on the HDD bracket.



3. Place the HDD into the bracket and gently push it down to make it firmly attach to the thermal pad. Use a Philips screwdriver to fix the HDD with M3 flat-head screws. Please note that the HDD must be placed in the right direction as below.



(another 2 screws are on the opposite side)

4. Pull out the SATA cable inside the chassis and connect it to HDD



5. Tilt the HDD assembly and insert the wedge of HDD bracket to the bottom cover. Once it's firmly wedged, push it down and fix it using a M3 flat-head screw.



3.3 Install Mini-PCle Module

3.3.1 Install Mini-PCle Module to Nuvo-3100VTC

1. Put the Nuvo-3100VTC upside down on a flat surface. You can see the “Pet-Door” along with HDD bracket exposed. Use a Philips screwdriver to loosen the M3 flat-head screw and open then remove it.



2. Turn your Nuvo-3100VTC to normal position. Unscrew 4 hex bolts on the top of the heat sink.



2. Unscrew 5 hex bolts on the front panel and remove the front panel.



- Unscrew 4 hex bolts on the back panel and remove the back panel.



- Gently slide out the bottom cover from Nuvo-3100VTC PCBA/heat-sink assembly till the SATA signal and power cable for HDD tray exposed. After removing cables from the connectors, continue slide bottom cover out.

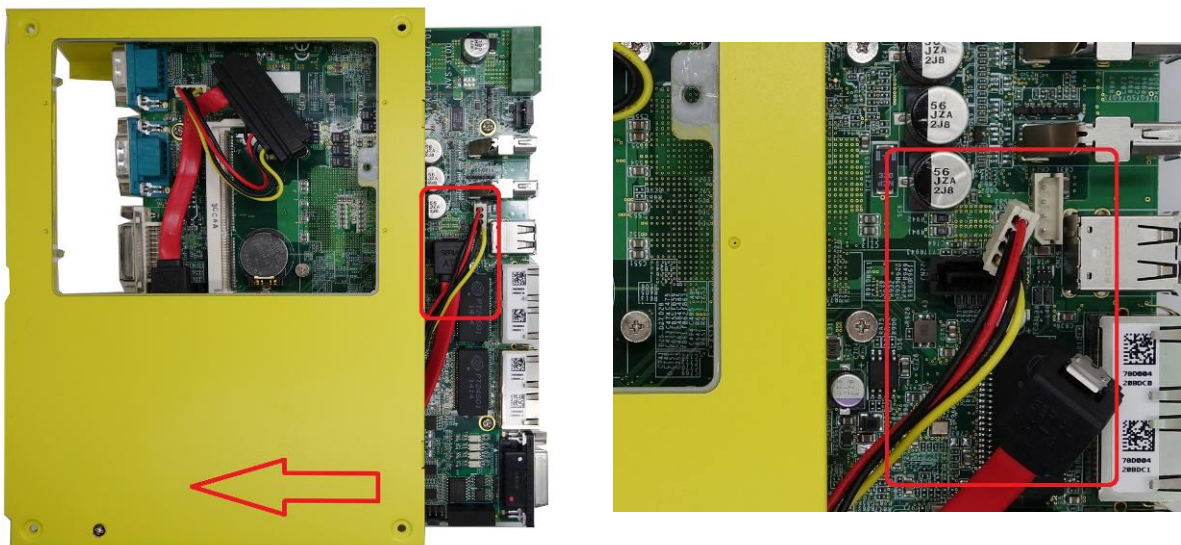

- You can see two SIM card, one half-size mini-PCIe, one full-size mini-PCIe and one mSATA socket exposed.

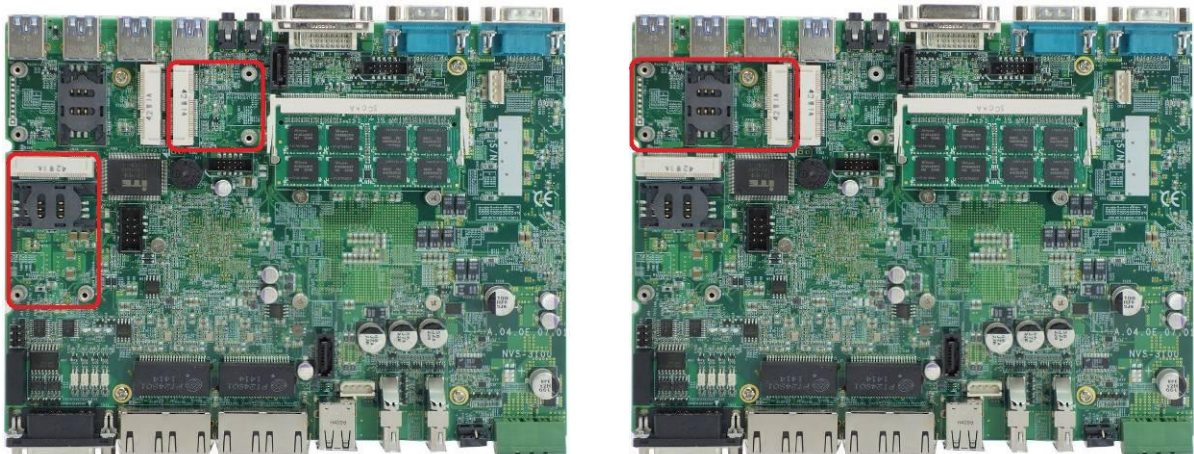

(full-size & half-size mini-PCIe socket)

(mSATA socket)

- Tilt the mini-PCIe module and insert it into the mini-PCIe/mSATA socket. And fix the module with two M2.5 P-head screws.



- Attach the IPEX-to-SMA cable to the module if needed.



- Assemble back panel to Nuvo-3100VTC PCBA/heat-sink assembly and fix 2 hex bolts. Then fix the SMA connector of the IPEX-to-SMA cable to the back panel.

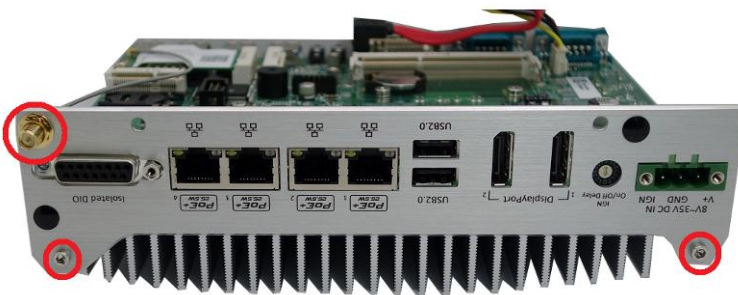

- Assemble bottom cover with Nuvo-3100VTC PCBA/heat-sink assembly, and push it back till the SATA signal and power cables for HDD tray reaches the connectors. Plug the SATA and power cable into connectors then push the bottom cover till it's fully attached to back panel.

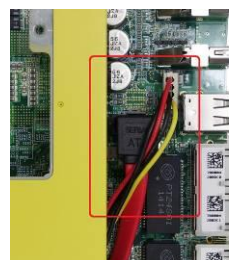

10. Fix 2 hex bolts on the back-panel.



11. Assemble the front panel with Nuvo-3100VTC PCBA/heat-sink assembly and fix 5 hex bolts on it.



12. Tilt the HDD assembly and insert the wedge of HDD bracket to the bottom cover. Once it's firmly wedged, push it down and fix it using a M3 flat-head screw.

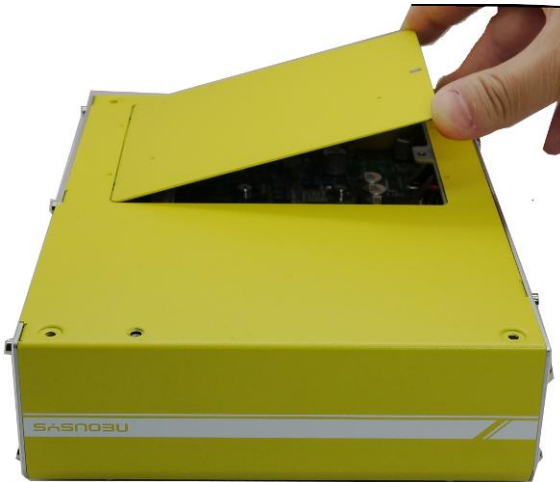

13. Attach the antenna to the SMA connector.



3.3.2 Install Mini-PCle Module to Nuvo-3120

1. Put the Nuvo-3120 upside down on a flat surface. You can see the “Pet-Door” along with HDD bracket exposed. Use a Philips screwdriver to loosen the M3 flat-head screw and open then remove it.



2. Turn your Nuvo-3120 to normal position. Unscrew 4 hex bolts on the top of the heat sink.



3. Unscrew 5 hex bolts on the front panel and remove the front panel.



4. Unscrew 4 hex bolts on the back panel and remove the back panel.



5. Gently slide out the bottom cover of Nuvo-3120.



6. You can see two SIM card, one half-size mini-PCle, one full-size mini-PCle and one mSATA socket exposed.

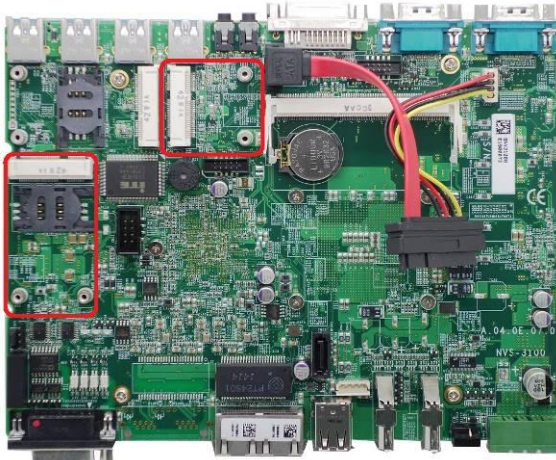

(full-size & half-size mini-PCle socket)

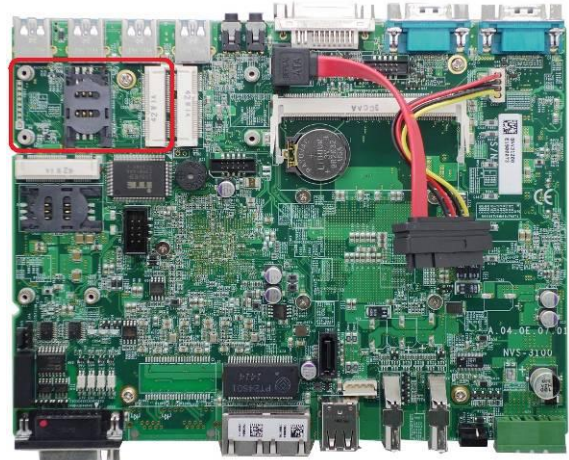

(mSATA socket)

7. Tilt the mini-PCle/mSATA module and insert it to the mini-PCle/mSATA socket. And fix the module with two M2.5 P-head screws.



- Attach the IPEX-to-SMA cable to the module if needed.

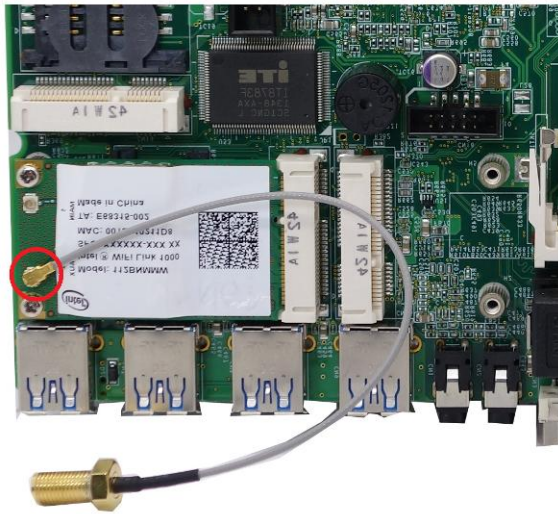

- Assemble back panel with Nuvo-3120 PCBA/heat-sink assembly and fix 2 hex bolts. Then fix the SMA connector of the IPEX-to-SMA cable to the back panel.



- Assemble bottom cover with Nuvo-3120 PCBA/heat-sink assembly, and push it back till it's attached to the back panel.



- Fix 2 hex bolts on the back-panel.



- Assemble the front panel with Nuvo-3120 PCBA/heat-sink assembly and fix 5 hex bolts on it.



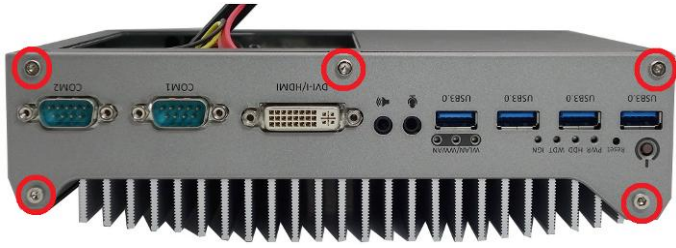

13. Tilt the HDD assembly and insert the wedge of HDD bracket to the bottom cover. Once it's firmly wedged, push it down and fix it using a M3 flat-head screw



14. Attach the antenna to the SMA connector.



3.4 Mount your Nuvo-3100 Series

Nuvo-3100 series provides versatile ways of mounting. Nuvo-3100VTC is shipped with dedicated damping brackets for in-vehicle installation. Or you can use wall-mounting brackets shipped with Nuvo-3120 to mount it on the wall/surface. Neousys also offers optional bracket and DIN rail clip to mount Nuvo-3100VTC/3120 on a DIN rail. To mount your Nuvo-3100 series, please refer to the information listed below.

3.4.1 Mount your Nuvo-3100VTC with Dedicated Damping Brackets

Considering in-vehicle deployment, Nuvo-3100VTC is shipped with dedicated damping bracket to absorb shock/vibration. You can mount your Nuvo-3100VTC with damping bracket by following the steps listed below.

1. Get damping bracket, eight M4 step screws and eight shock-absorbing grommets from the accessory box.
2. Insert the grommets into the brackets. Fix the damping brackets to Nuvo-3100VTC using four M4 step screws.

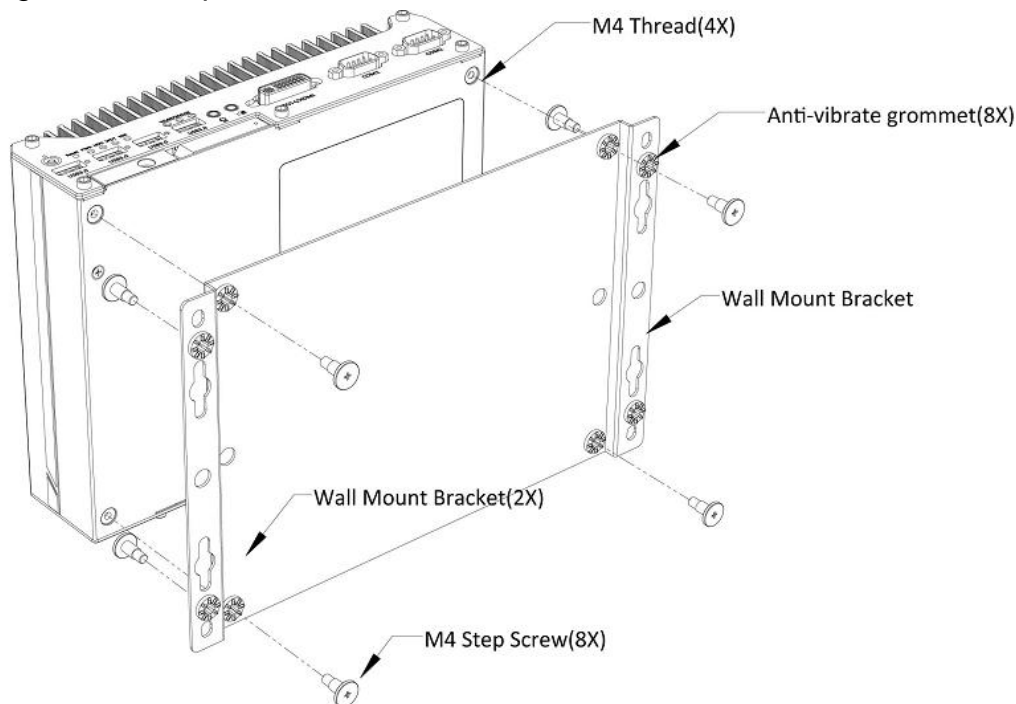

3. Place Nuvo-3100VTC on a flat surface and fix it to the surface with another four M4 step screws. Make sure the mounting holes on the surface follow the correct pitch as below.

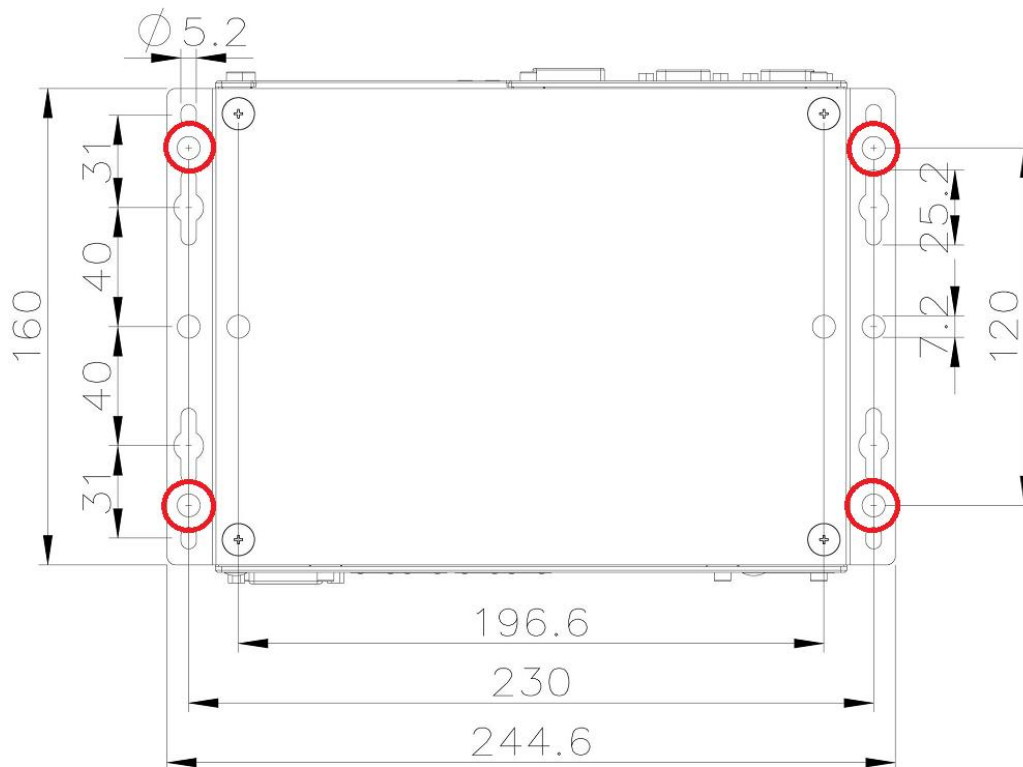

3.4.2 Mount your Nuvo-3120 on the Wall/Surface

Nuvo-3120 is shipped with wall-mount brackets as the standard mounting option. You can mount your Nuvo-3120 on the wall/surface by following the steps listed below.

1. Get two wall-mounting brackets and four M4 screws from the accessory box. Fix the mounting brackets to Nuvo-3120 using M4 screws.

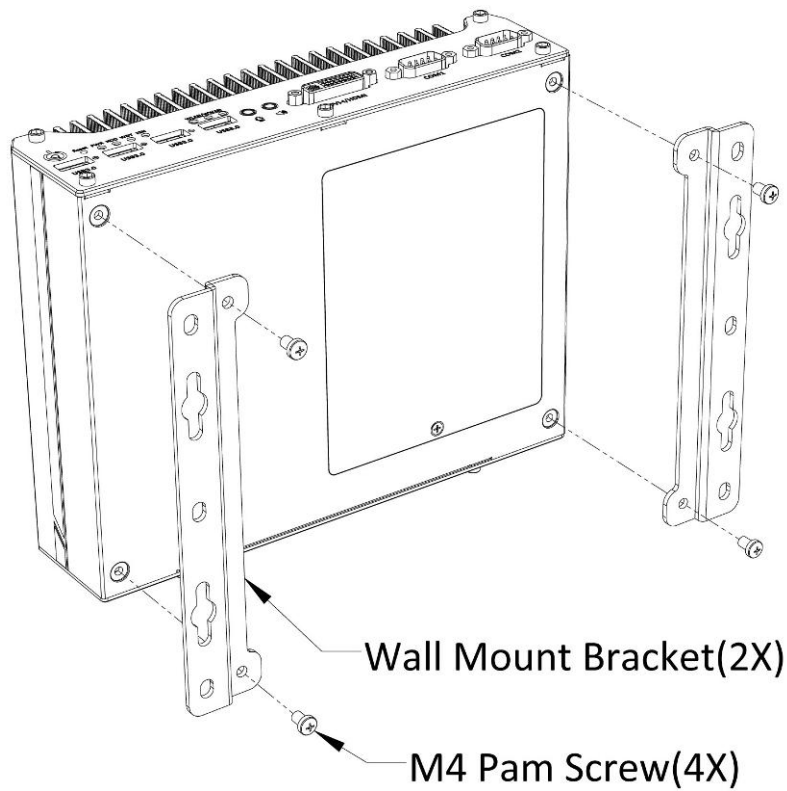

- Place Nuvo-3120 on a flat surface and fix it with screws. You can also take advantage of the keyhole-shaped holes of mounting brackets to suspend Nuvo-3120 on the Wall.

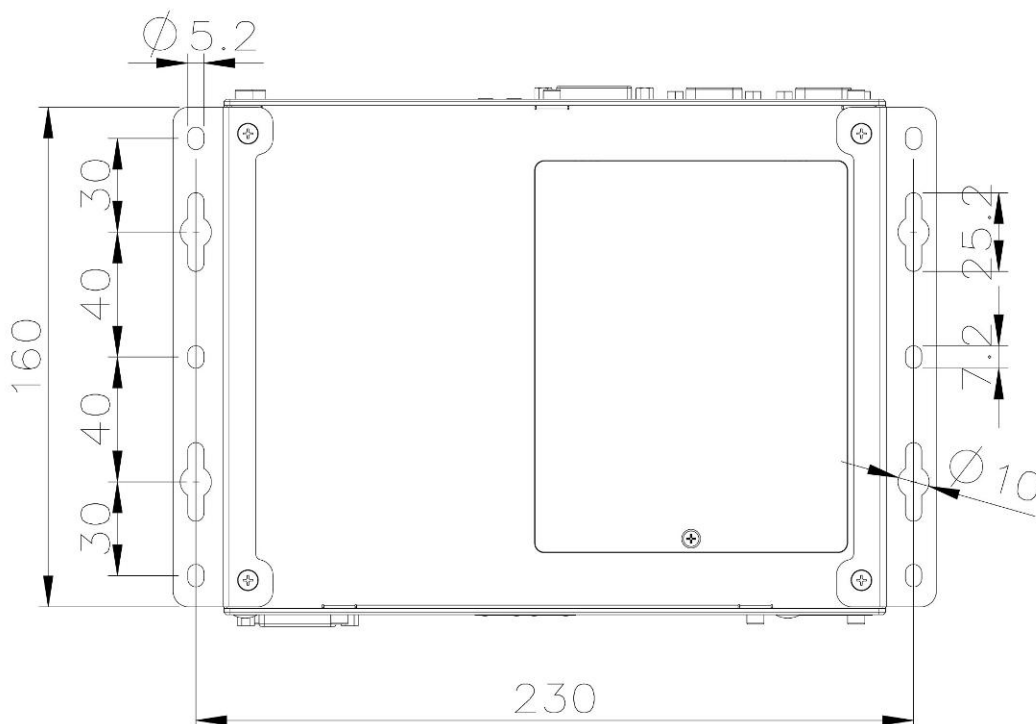

- For best efficiency of heat dissipation, please mount Nuvo-3120 in a right direction.

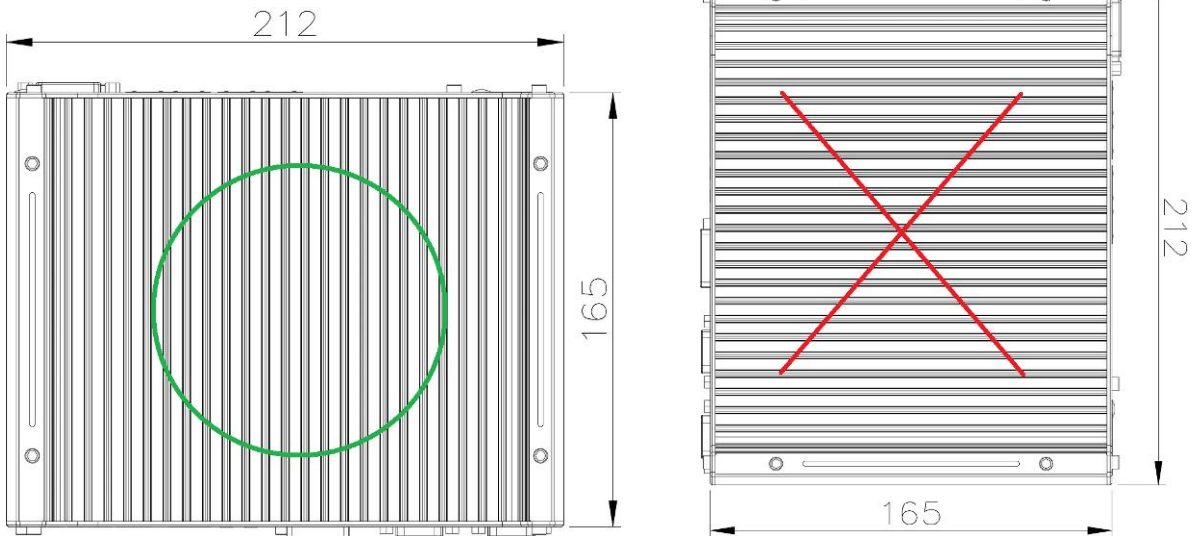

3.4.3 Mount your Nuvo-3100 Series on the DIN Rail

Neusys also provides the option of the DIN-rail mounting kit. The kit includes a bracket and a DIN-rail mounting clip. You should fix the clip to the bracket using four M4 flat-head screws first, and then fix the bracket assembly to Nuvo-3100 series with another four M4 screws. This option can be useful if you want to deploy Nuvo-3100 series inside an equipment cabinet where DIN rail is available.

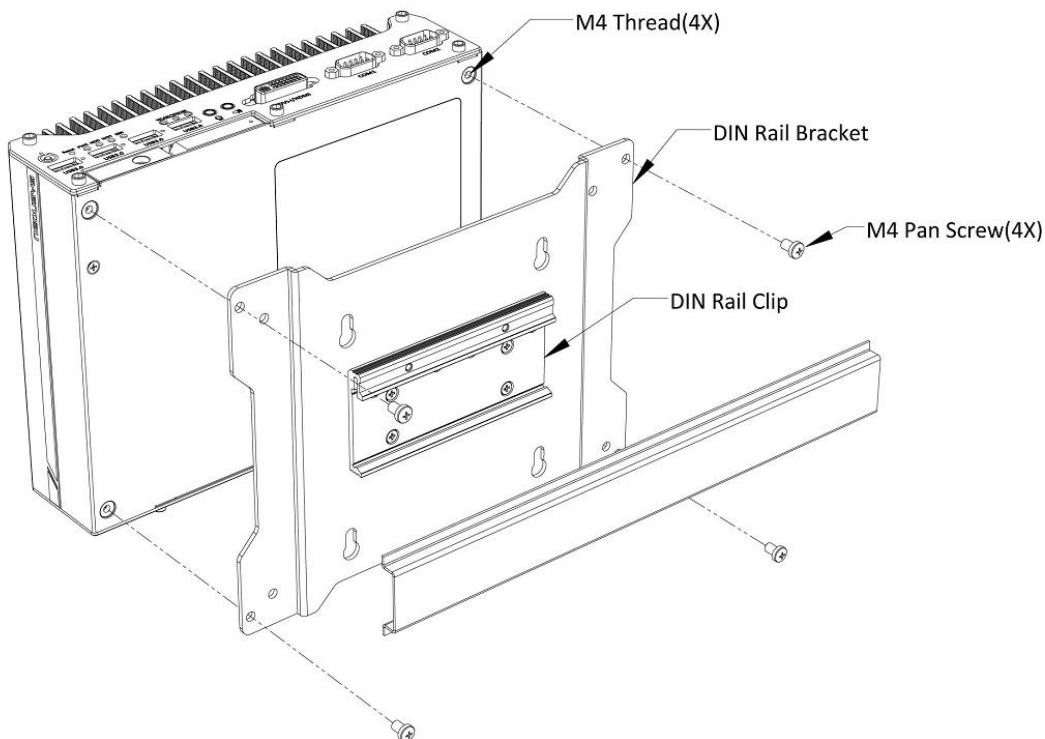

3.5 Connect DC power to you Nuvo-3100 Series

Nuvo-3100 series uses a 3-pin pluggable terminal block to accept 8~35V DC power input. It provides the way for directly wiring the DC power. To connect DC power via the 3-pin pluggable terminal block, please follow the steps listed below.

1. Make sure the external DC power supply is power off or disconnected before wiring.
2. Get the 3-pin pluggable terminal block from the accessory box. The terminal block fits the wires with a gauge of 12~24 AWG.
3. Carefully identify the positive and negative contacts of your DC power supply and pluggable terminal block. The polarities between DC power supply and terminal block must be positive (+) to positive (+) and ground (GND) to ground (GND). Insert the wires to correct contacts of pluggable terminal block and tighten clamping screws using a Philips screwdriver.



4. Firmly plug the terminal block into a receptacle on the back panel, and tighten the captive screws using a Slotted screwdriver.

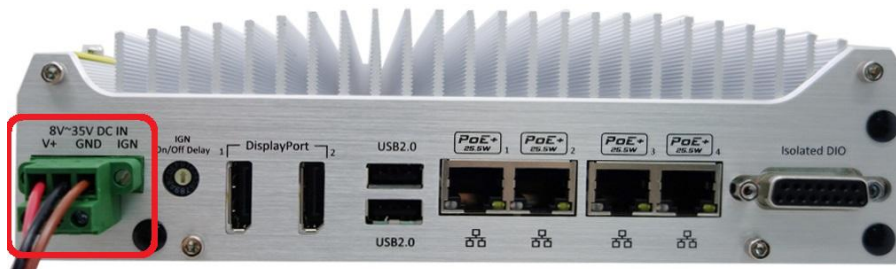

Caution

1. Nuvo-3100 series accepts 8~35 VDC when using terminal block for DC input. Please make sure the voltage and polarity of DC power is correct before you connect it to Nuvo-3100 series. Supplying a voltage over 35V will damage the system.

3.6 Power on your Nuvo-3100 Series

For better flexibility of operation, Nuvo-3100 series provides three alternatives to power on your Nuvo-3100. You can turn on your Nuvo-3100 by pressing the power button, using an external non-latched on/off switch, or by sending a special LAN packet. In this section, we illustrate these ways to power on your Nuvo-3100.

3.6.1 Power on Nuvo-3100 Series Using the Power Button

This is the simplest way to turn on your Nuvo-3100 series. The power button on the front panel is a non-latched switch and behaves the ATX-mode on/off control. As DC power is connected, push the power button will turn on the system as well as the PWR LED indicator. Push the button when system is on will turn off the system. If your operating system supports ATX power mode (i.e. Microsoft Windows or Linux), push the power button causes a pre-defined system behavior, such as shutdown or hibernation.



3.6.2 Power on Nuvo-3100 Series Using External Latched Switch

For applications which place Nuvo-3100 series inside a cabinet, it's useful to control the on/off of the system using an external switch. You can take advantage of V+ and IGN input of Nuvo-3100VTC/3120 to connect the latched switch for remote on/off control. To power on Nuvo-3100VTC/3120 using an external latched switch, please follow the steps listed below

Note: This function is available for Nuvo-3100VTC/3120 Rev. A2 or later revision.

1. Set the IGN On/Off Delay rotary switch to position 2.



2. Prepare a latching switch and connect it to V+ and IGN of the 3-pin pluggable terminal block (polarity is negligible).

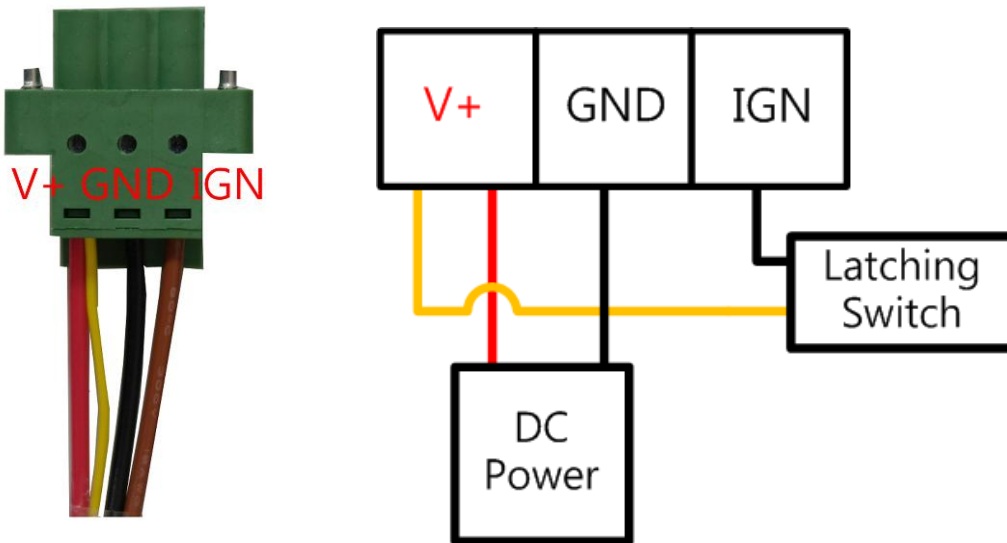

3. When the switch is closed, a power-on operation is initiated to turn on the system. When the switch is opened, a system shutdown process is initiated to turn off the system (soft-off).

3.6.3 Power on Nuvo-3100 Series Using Wake-on-LAN Function

Wake-on-LAN (WOL) is a mechanism to wake up a computer system from a S5 (system off with standby power) state via issuing a magic packet. Nuvo-3100 series implements the Wake-on-LAN function for its first GbE port.



To enable WOL function and power on you Nuvo-3100 series, please follow the steps listed below.

For Windows XP

1. When Nuvo-3100 series boots up, press F2 to enter BIOS setup utility.
2. Enter the **[Power]** menu. And configure the **[Wake On LAN]** option as **[Enabled]**. This setting enables the Wake-on-LAN function for Nuvo-3100 series. Please refer to section 4.1.8 for the instruction of configuring this BIOS option.



- In Windows XP system, identify the Local Area Connection of Intel® 82579LM Gigabit Controller and click the **Configure** button.

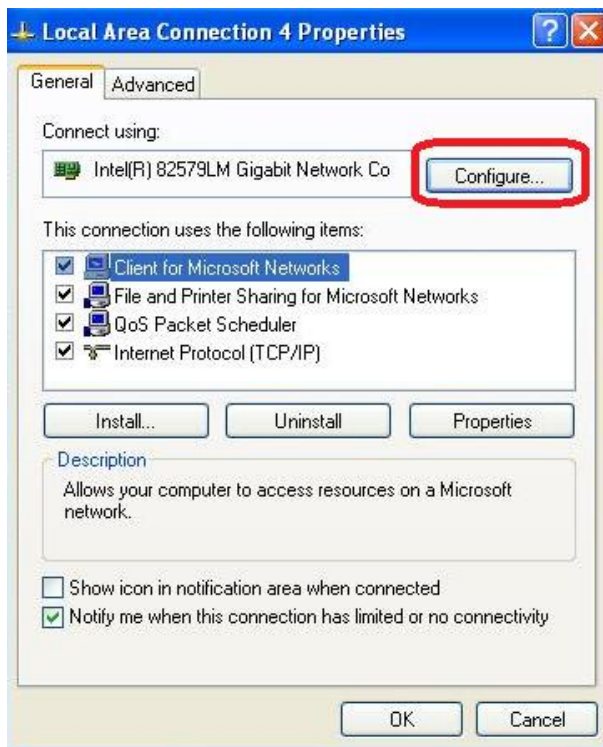

Click the Power Management tag, and configure the following two options accordingly.

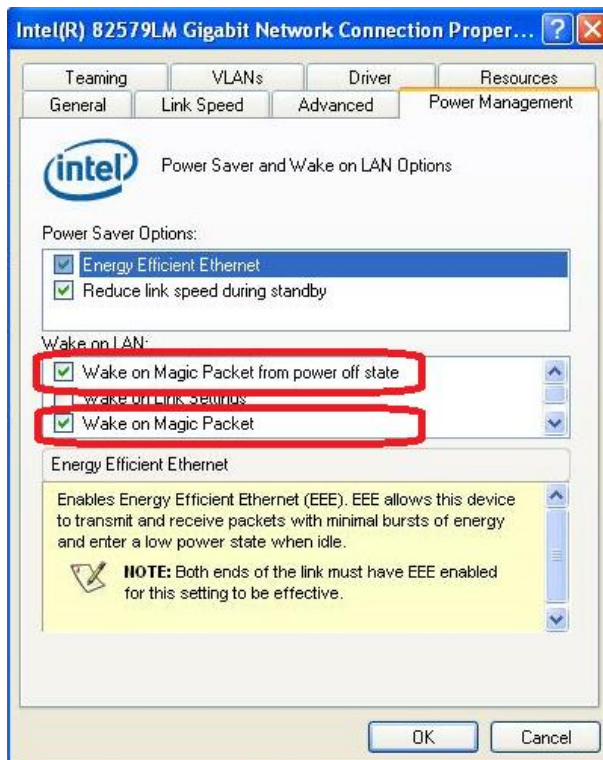

- **Wake on Magic Packet**

Nuvo-3100 series can wake from S5 state when receiving a magic packet. The magic packet is a broadcast frame containing anywhere within its payload 6 bytes

of all 255 (FF FF FF FF FF FF in hexadecimal), followed by sixteen repetitions of the target computer's 48-bit MAC address.

For example, NIC's 48-bit MAC Address is 78h D0h 04h 0Ah 0Bh 0Ch

```

DESTINATION SOURCE MISC
FF FF FF FF FF FF
78 D0 04 0A 0B 0C 78 D0 04 0A 0B 0C
78 D0 04 0A 0B 0C 78 D0 04 0A 0B 0C
78 D0 04 0A 0B 0C 78 D0 04 0A 0B 0C
78 D0 04 0A 0B 0C 78 D0 04 0A 0B 0C
78 D0 04 0A 0B 0C 78 D0 04 0A 0B 0C
78 D0 04 0A 0B 0C 78 D0 04 0A 0B 0C
78 D0 04 0A 0B 0C 78 D0 04 0A 0B 0C
78 D0 04 0A 0B 0C 78 D0 04 0A 0B 0C
MISC    CRC

```

There are some free tools available on Internet that can be used to send a magic packet. Please refer to the following link to understand more about Magic Packet.
<http://en.wikipedia.org/wiki/Wake-on-LAN>

For Windows 7

1. When Nuvo-3100 boots up, press F2 to enter BIOS setup utility.
2. Enter the **[Power]** menu. And configure the **[Wake On LAN]** option as **[Enabled]**.
This setting enables the Wake-on-LAN function for Nuvo-3100 series. Please refer to section 4.1.8 for the instruction of configuring this BIOS option.
3. In Windows 7 system, identify the Local Area Connection of corresponding Intel® I210 Gigabit Controller and click the **Configure** button.



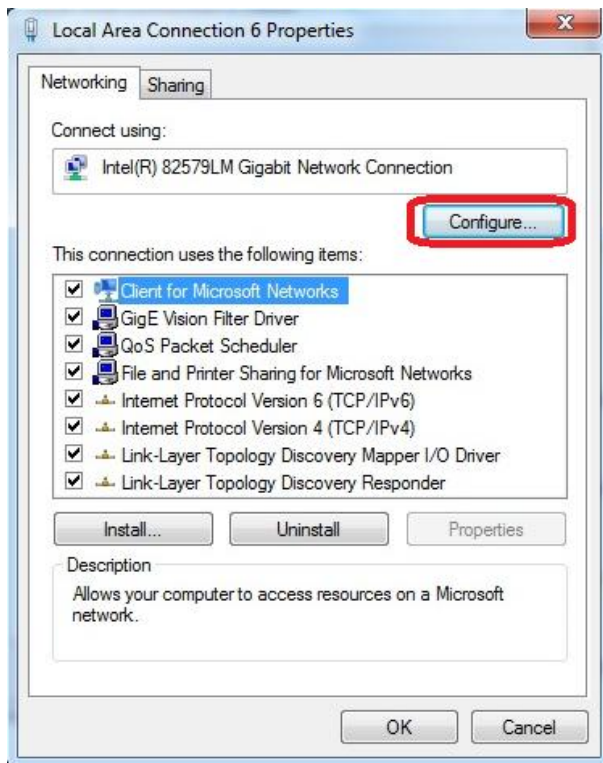

4. Click the **Power Management** tag, and check the following two options accordingly

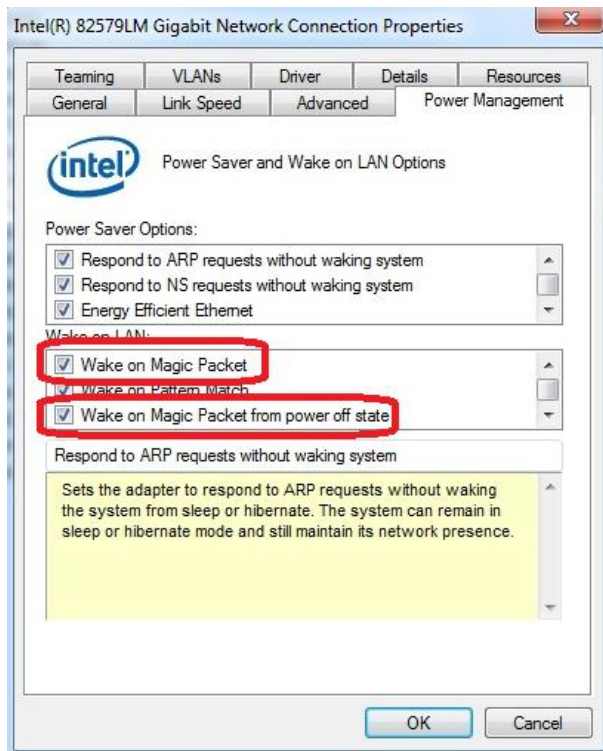

3.7 Ignition Power Control (Nuvo-3100VTC Only)

Nuvo-3100VTC implements the feature of ignition power control module for in-vehicle applications. It's a MCU-based implementation that monitors the ignition signal and reacts to turn on/off the system according to predefined on/off delay. Its built-in algorithm supports further features such as ultra-low standby power, battery-low protection, system hard-off and etc. In this section, we'll illustrate the principle of ignition power control and operations modes on Nuvo-3100VTC.

3.7.1 Principle of Ignition Power Control

The basic concept of ignition power control module is to control the timing correlation between ignition signal and system power status. A typical timing correlation can be described in following diagram.

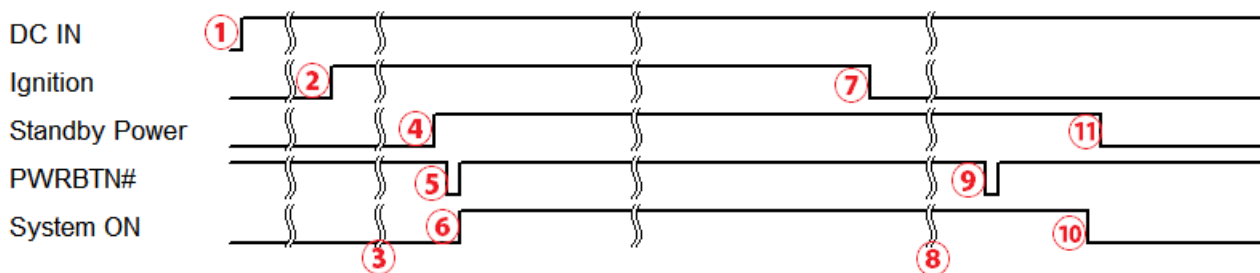

- 1) When DC input is supplied to Nuvo-3100VTC, MCU starts to periodically detect ignition signal. Note that only MCU is working at this moment and the overall power consumption is less than 2 mW.
- 2) Ignition signal is active. (Both 12VDC and 24VDC ignition signals are accepted)
- 3) MCU starts to count a pre-defined power-on delay.
- 4) Once power-on delay expired, MCU turns on necessary standby power for Nuvo-3100VTC (3.3VSB & 5VSB).
- 5) A PWRBTN# pulse is then issued to turn on the system (a similar behavior as you press the power button on the front panel).
- 6) Nuvo-3100VTC is booting up and running.
- 7) After a period of time, the ignition signal is inactive.
- 8) MCU starts to count a pre-defined power-off delay.
- 9) Once power-off delay expired, another PWRBTN# pulse is issued to perform a soft-off for the system (ex. a normal shutdown process for Windows system).
- 10) Nuvo-3100VTC is completely shut down.
- 11) As MCU detects system is off, it turns off the standby power for Nuvo-3100VTC, and then operates in low power mode again (< 2mW power consumption).



In addition to the typical timing correlation, the ignition power control module offers some further features to make Nuvo-3100VTC more reliable for in-vehicle applications.

1. Low battery detection

The ignition power control module is capable to continuously monitor the voltage of DC input when system is running. If input voltage is less than 9V (for 12VDC input) or less than 18V (for 24VDC input) over a 60 seconds duration, it will shut down the system automatically.

2. Guarded power-on/power-off delay duration

If ignition signal goes inactive during the power-on delay duration, the ignition power control module will cancel the power-on delay process and go back to idle status.

Likewise if ignition signal goes active during the power-off delay duration, the ignition power control module will cancel the power-off delay process and keep the system running.

3. System hard-off

In some cases, system may be failed to normally shutdown via a soft-off operation due to system/application halts. The ignition power control module on Nuvo-3100VTC offers a mechanism called “hard-off” to handle this unexpected condition. By detecting the system status, it can determine whether the system is normally shutdown. If not, the ignition power control module will compulsively cut off the system power 10 minutes after the power-off delay duration.

4. Smart off-delay

The ignition power control module on Nuvo-3100VTC offers two modes (mode 6 & mode 7) which have very long power-off delay duration for applications require some off-line processing after vehicle is stopped. In these two modes, the ignition power control module will automatically detect the system status during the power-off delay duration. If the system is shutdown (by the application software) in prior to power-off delay expired, it will cut off the system power immediately to prevent further consumption of battery power.

3.7.2 Wiring Ignition Signal

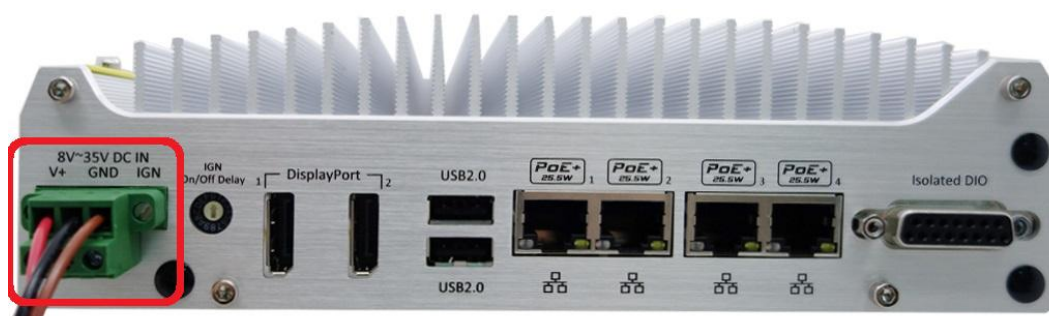

To have ignition power control for in-vehicle usage, you need to supply IGN signal to Nuvo-3100VTC. The IGN input is located on the back panel via a 3-pin pluggable terminal block (shared with DC power input). Here is a general wiring configuration for in-vehicle deployment.

1. Connect car Battery+ line (12V for sedan, 24V for bus/truck) to V+.
2. Connect car Batter-/GND line to GND.
3. Connect ACC line to IGN.

Note

1. *Please make sure your DC power source and IGN signal share the same ground.*
2. *IGN input of Nuvo-3100VTC accepts 8~35VDC. Supply a voltage higher than 35VDC may damage the system.*



3.7.3 Operation Modes of Ignition Power Control

If the option of ignition power control modules is available, you can use the rotary switch on SBC to configure the operation mode. Nuvo-3100VTC offers 8 operation modes (Rev. A1) or 16 operation mode (Rev. A2 or later) with different power-on/power-off delay configurations.

For Nuvo-3100VTC Rev. A3 (with BIOS rev. NV31A003.Build150312 or later revision), a new ignition control module is implemented to support BIOS-configurable ignition control. When rotary switch is set to mode 15 (0xF), ignition power control is executed according to parameters configured in BIOS setup menu, which allows richer combination of power-on/power-off delay and more detailed control parameters. Mode 0 ~ 14 (0xE) remains the same as Nuvo-3100VTC rev. A2.

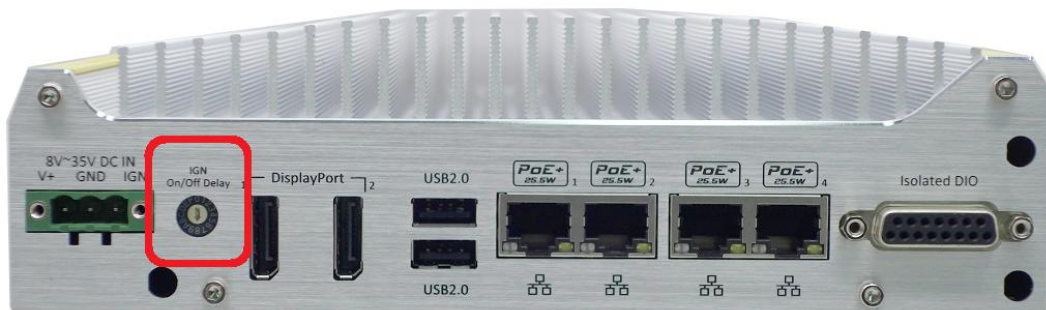

Note

For Nuvo-3120 Rev. A1 (S/N from E2500001 to E2500100), please always set the rotary switch to 8 otherwise the system may be failed to operate.

For Nuvo-3100VTC Rev. A1

- **Mode 0**

Mode 0 is the ATX mode without power-on and power-off delay. User can only use the power button on the front panel to turn on or turn off the Nuvo-3100VTC system.

Mode	Power-on Delay	Power-off Delay	Hard-off Timeout
0	N/A	N/A	N/A

- **Mode 1**

If Mode 1 is specified, the system automatically turns on the system when DC power is applied. A retry mechanism is designed to repeat the power-on cycle if the system is failed to boot up.

Mode	Power-on Delay	Power-off Delay	Hard-off Timeout
1	N/A	N/A	N/A



- **Mode 2 / Mode 3 / Mode 4 / Mode 5**

Mode 2 ~ Mode 5 are ignition power control modes with various power-on delay and power-off delay. Each mode supports a hard-off timeout of 10 minutes.

Mode	Power-on Delay	Power-off Delay	Hard-off Timeout
2	10 seconds	10 seconds	10 minutes
3	30 seconds	1 minute	10 minutes
4	30 seconds	5 minutes	10 minutes
5	30 seconds	30 minutes	10 minutes

- **Mode 6 / Mode 7**

Mode 6 and Mode 7 are ignition power control modes with very long power-off delay. Both modes support the feature of “smart off-delay”, which automatically detect system status during power-off delay duration and cut off system power if system is off in prior to power-off delay expired.

Mode	Power-on Delay	Power-off Delay	Hard-off Timeout
6	30 seconds	2 hours	10 minutes
7	30 seconds	5 hours	10 minutes

For Nuvo-3100VTC Rev. A2

- **Mode 0**

Mode 0 is the ATX mode without power-on and power-off delay. User can only use the power button on the front panel to turn on or turn off the Nuvo-3100VTC system.

Mode	Power-on Delay	Power-off Delay	Hard-off Timeout
0	N/A	N/A	N/A

- **Mode 1**

If Mode 1 is specified, the system automatically turns on the system when DC power is applied. A retry mechanism is designed to repeat the power-on cycle if the system is failed to boot up.

Mode	Power-on Delay	Power-off Delay	Hard-off Timeout
1	N/A	N/A	N/A

- **Mode 2 (available for both Nuvo-3100VTC and Nuvo-3120)**

Mode 2 is a special mode designed to support remote on/off control. User can use an external latched switch to connect the DC source (8~35V) and IGN input. When the switch is closed, IGN signal is asserted to initiate a power on operation. When the



switch is opened, IGN signal is de-asserted and system shutdown operation is initiated. Neither power-on delay nor power-off delay is supported in this mode.

Mode	Power-on Delay	Power-off Delay	Hard-off Timeout
2	N/A	N/A	N/A

- **Mode 3 ~ Mode 12**

Mode 3 ~ Mode 12 are ignition power control modes with various power-on delay and power-off delay. Each mode supports a hard-off timeout of 10 minutes.

Mode	Power-on Delay	Power-off Delay	Hard-off Timeout
3	10 seconds	10 seconds	10 minutes
4	10 seconds	1 minute	10 minutes
5	10 seconds	5 minutes	10 minutes
6	30 seconds	1 minute	10 minutes
7	30 seconds	5 minutes	10 minutes
8	30 seconds	10 minutes	10 minutes
9	3 minutes	1 minute	10 minutes
10	3 minutes	10 minutes	10 minutes
11	3 minutes	30 minutes	10 minutes
12	10 minutes	30 minutes	10 minutes

- **Mode 13 / Mode 14 / Mode 15**

Mode 13, Mode 14 and Mode 15 are ignition power control modes with very long power-off delay. Both modes support the feature of “smart off-delay”, which automatically detect system status during power-off delay duration and cut off system power if system is off in prior to power-off delay expired.

Mode	Power-on Delay	Power-off Delay	Hard-off Timeout
13	30 seconds	2 hours	10 minutes
14	3 minutes	2 hours	10 minutes
15	30 seconds	5 hours	10 minutes

For Nuvo-3100VTC Rev. A3 (with BIOS Rev. NV31A003.Build150312)

- **Mode 0**

Mode 0 is the ATX mode without power-on and power-off delay. User can only use the power button on the front panel to turn on or turn off the Nuvo-3100VTC system.

Mode	Power-on Delay	Power-off Delay	Hard-off Timeout
0	N/A	N/A	N/A



- **Mode 1**

If Mode 1 is specified, the system automatically turns on the system when DC power is applied. A retry mechanism is designed to repeat the power-on cycle if the system is failed to boot up.

Mode	Power-on Delay	Power-off Delay	Hard-off Timeout
1	N/A	N/A	N/A

- **Mode 2 (available for both Nuvo-3100VTC and Nuvo-3120)**

Mode 2 is a special mode designed to support remote on/off control. User can use an external latched switch to connect the DC source (8~35V) and IGN input. When the switch is closed, IGN signal is asserted to initiate a power on operation. When the switch is opened, IGN signal is de-asserted and system shutdown operation is initiated. Neither power-on delay nor power-off delay is supported in this mode.

Mode	Power-on Delay	Power-off Delay	Hard-off Timeout
2	N/A	N/A	N/A

- **Mode 3 ~ Mode 12**

Mode 3 ~ Mode 12 are ignition power control modes with various power-on delay and power-off delay. Each mode supports a hard-off timeout of 10 minutes.

Mode	Power-on Delay	Power-off Delay	Hard-off Timeout
3	10 seconds	10 seconds	10 minutes
4	10 seconds	1 minute	10 minutes
5	10 seconds	5 minutes	10 minutes
6	30 seconds	1 minute	10 minutes
7	30 seconds	5 minutes	10 minutes
8	30 seconds	10 minutes	10 minutes
9	3 minutes	1 minute	10 minutes
10	3 minutes	10 minutes	10 minutes
11	3 minutes	30 minutes	10 minutes
12	10 minutes	30 minutes	10 minutes

- **Mode 13 / Mode 14**

Mode 13 and Mode 14 are ignition power control modes with very long power-off delay. Both modes support the feature of “smart off-delay”, which automatically detect system status during power-off delay duration and cut off system power if system is off in prior to power-off delay expired.

Mode	Power-on Delay	Power-off Delay	Hard-off Timeout
13	30 seconds	2 hours	10 minutes
14	3 minutes	2 hours	10 minutes



● Mode 15

For Nuvo-3100VTC with BIOS rev. NV31A003.Build150312 or later revision, a new ignition control module is implemented to support BIOS-configurable ignition parameters. When the rotary switch is set to 15 (0xF), users can configurable parameters in BIOS setup menu.

To configure ignition parameters in BIOS, please follow the steps below.

1. Make sure you have set the rotary switch to position 15 (0xF).
2. When system boots up, press F2 to enter BIOS setup menu.
3. Go to **[Power]** → **[Ignition Power Control]**.

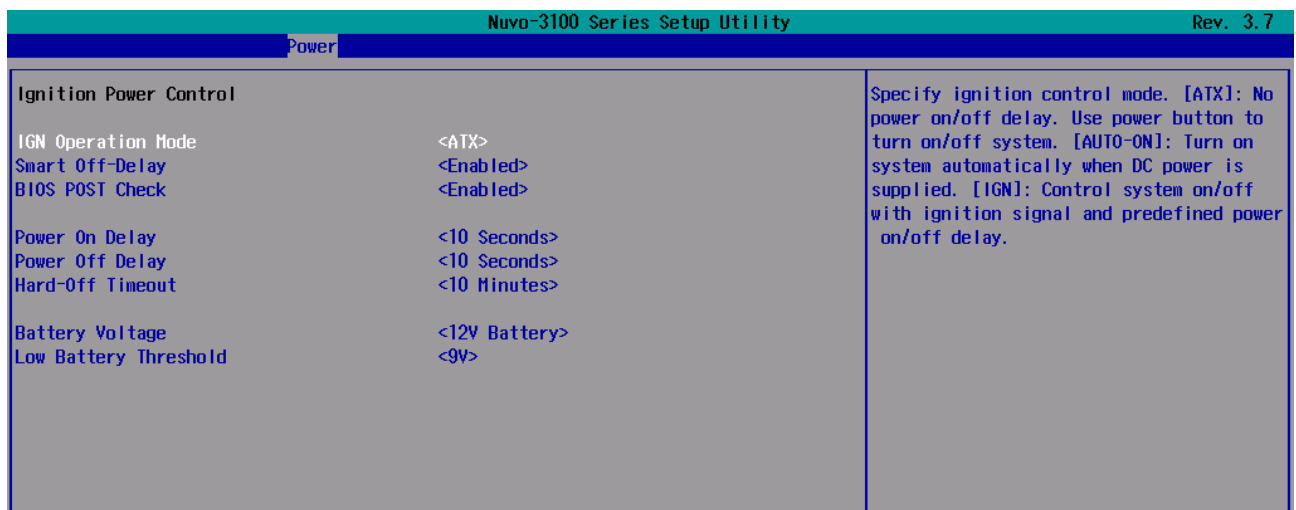

4. You can configure parameters for ignition power control according to your application.

[IGN Operation Mode]

ATX	ATX mode without power-on and power-off delay. Same operation as rotary switch set to 0.
AUTO-ON	Automatically turns on the system when DC power is applied. Same operation as rotary switch set to 1.
IGN	Ignition power control mode. Ignition control is executed according to the specified parameters.

[Smart Off-Delay]

Enabled	If system is manually shutdown during the power-off delay period, ignition control module will cut off system power in prior to expiration of power-off delay to save battery power.
Disabled	Ignition control module cut off system power only after power-off delay expired.

[BIOS POST Check]

Enabled	This option secures a boot-to-OS operation. If the system is failed to boot to OS (e.g. disk failure or no bootable device) within 60 seconds, ignition control module will cut off system power and retry another power on cycle.
Disabled	BIOS POST check is skipped.

[Power On Delay]

Specify the power-on delay duration. Once IGN signal goes active and sustains for the duration of power-on delay, ignition control module turns on system power and boot up the system.

[Power Off Delay]

Specify the power-off delay duration. Once IGN signal goes inactive and sustains for the duration of power-off delay, ignition control module performs system shutdown (soft-off) and then cut off system power.

[Hard-off Timeout]

Specify system hard-off timeout. Once system failed to normally shutdown via a soft-off operation due to system/application halts (e.g. Windows BSOD), ignition control module can compulsively cut off system power after the given hard-off timeout.

[Battery Voltage]

Specify the battery voltage of the vehicle where Nuvo-3100VTC is deployed. Typically it's 12 VDC for sedan and 24 VDC for bus/truck.

[Low Battery Threshold]

When system is running, ignition control module continuously monitors the battery voltage. Once the battery voltage is lower than the specified threshold, it performs system shutdown (soft-off) and cut off system power to prevent battery drain-out. You should specify the low battery threshold according to the given battery voltage.

5. Press F10 to save specified parameter. The ignition control module will be reset and then operate according to parameters configured in BIOS setup menu.



Chapter 4 BIOS and Driver

4.1 BIOS Settings

Nuvo-3100 series is shipped with factory-default BIOS settings cautiously programmed for best performance and compatibility. In this section, we'll illustrate some of BIOS settings you may need to modify. Please always make sure you understand the effect of change before you proceed with any modification.

4.1.1 COM1 & COM2 Operating Mode

COM1 and COM2 of Nuvo-3100 series support RS-232 (full-duplex), RS-422 (full-duplex) and RS-485 (half-duplex) mode. You can set the COM1/COM2 operating mode via BIOS settings. Another option in BIOS called "*Slew Rate*" defines how sharp the rising/falling edge is for the output signal of COM1/COM2. For long-distance RS-422/485 transmission, you may set the "*Slew Rate*" option as "High" to improve signal quality.

To set COM1/COM2 operating mode:

1. When Nuvo-3100 boots up, press F2 to enter BIOS setup utility.
2. Go to **[Advanced]** → **[Peripheral Configuration]**.
3. Set the **[Set COM1 as]** to a proper mode for COM1 of your Nuvo-3100.
4. Set the **[Set COM2 as]** to a proper mode for COM2 of your Nuvo-3100.

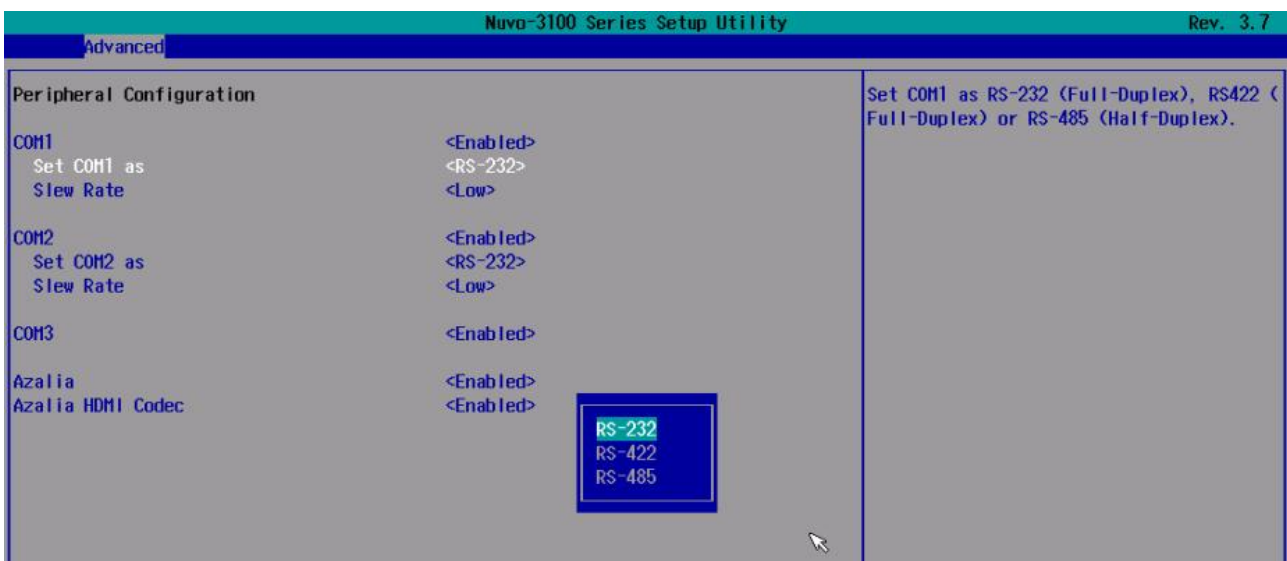

4.1.2 SATA Controller Mode for Nuvo-3100VTC

The SATA controller of Nuvo-3100VTC supports three operating modes: **IDE**, **AHCI** and **RAID** mode. **IDE** mode configures SATA controller to access SATA interface in legacy IDE mode, and is compatible with most storage devices. **AHCI** mode, which exposes SATA's advanced capabilities such as hot swapping and native command queuing, is supported in several later version of operating systems. **RAID** mode provides a more reliable data storage (RAID 1/5/10) or a higher disk access throughput (RAID 0). Nuvo-3100VTC features built-in hardware RAID. No additional H/W or driver is needed to use RAID function.

Our suggestion of how to set SATA controller mode is

- If you're using Windows XP, Linux kernel earlier than 2.6.19, you should select **IDE** mode.
- If you're using Windows Vista, Windows 7, Windows 8, or Linux kernel from 2.6.19 onward, you can select **AHCI** mode for better performance.
- If you're installing two 2.5" HDD/SSD and looking for data striping (RAID 0) or data mirroring (RAID 1), you can select **RAID** mode to utilize built-in RAID.

To set SATA controller mode:

1. When Nuvo-3100VTC boots up, press F2 to enter BIOS setup utility.
2. Go to **[Advanced]** → **[IDE Configuration]**.
3. Set the **[HDC Configure as]** to a proper mode for your Nuvo-3100VTC.



4.1.3 Configure Hot-Swappable HDD Tray of Nuvo-3100VTC

Nuvo-3100VTC features a hot-swappable HDD tray on its front panel for easy HDD access. The HDD tray can be configured as removable storage device so you can insert/remove a HDD/SSD when system's running, or configured as fixed storage device so you can install OS. You should configure operating mode of HDD tray according to your application.

To enable/disable hot-swap for HDD tray:

1. When Nuvo-3100VTC boots up, press F2 to enter BIOS setup utility.
2. Go to **[Advanced]** → **[IDE Configuration]**. An option named **[SATA Port HotPlug]** under **[SATA Port on HDD Tray]** is displayed.
3. If you need to configure the HDD tray as fixed storage device, please set the **[SATA Port HotPlug]** to **[Disabled]**.
4. If you need to configure the HDD tray as removable storage device, please set the **[SATA Port HotPlug]** to **[Enabled]**.



4.1.4 SATA Controller Mode for Nuvo-3120

The SATA controller of Nuvo-3120 supports two operating modes: **IDE** and **AHCI** mode. **IDE** mode configures SATA controller to access SATA interface in legacy IDE mode, and is compatible with most storage devices. **AHCI** mode, which exposes SATA's advanced capabilities such as hot swapping and native command queuing, is supported in several later version of operating systems.

Our suggestion of how to set SATA controller mode is

- If you're using Windows XP, Linux kernel earlier than 2.6.19, you should select **IDE** mode.
- If you're using Windows Vista, Windows 7, Windows 8, or Linux kernel from 2.6.19 onward, you can select **AHCI** mode for better performance.

To set SATA controller mode:

1. When Nuvo-3120 boots up, press F2 to enter BIOS setup utility.
2. Go to **[Advanced]** → **[IDE Configuration]**.
3. Set the **[HDC Configure as]** to a proper mode for your Nuvo-3100VTC.

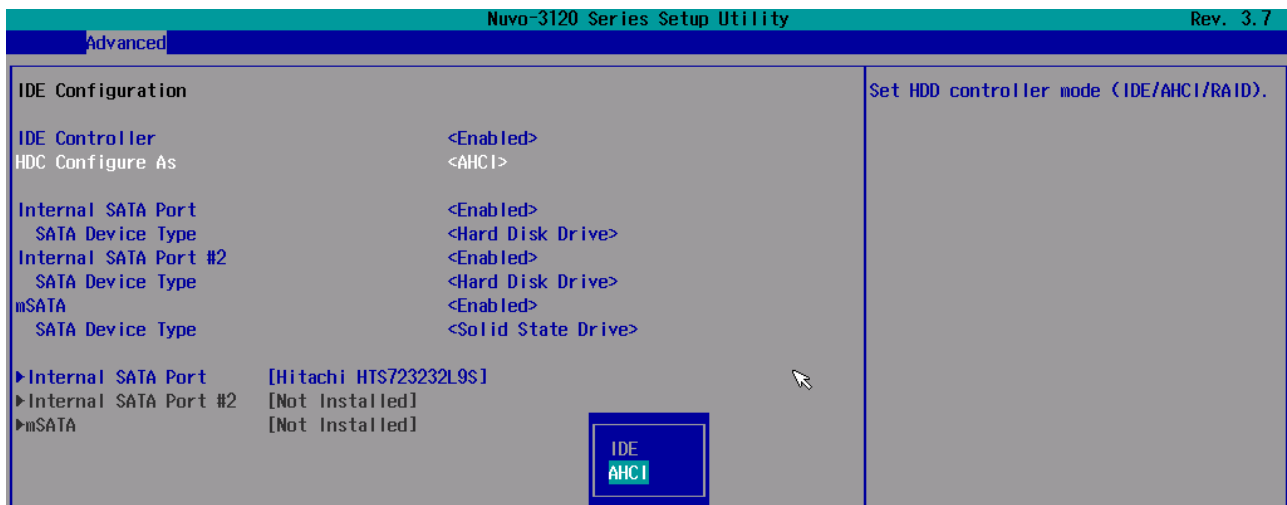

4.1.5 Power On after Power Failure Option

This option defines the behavior of Nuvo-3100 series when DC power is supplied.

Value	Description
S0 – Power On	System is powered on when DC power is supplied.
S5 – Power Off	System is kept in off state when DC power is supplied.
Last State	The on/off state of the system is determined according to the last state when DC power is disconnected. For example, if system is still on but DC power is unplugged, the system is powered on next time when DC power is supplied.

To set “Power On after Power Failure” option:

1. When Nuvo-3100 boots up, press F2 to enter BIOS setup utility.
2. Go to **[Advanced]** → **[Chipset Configuration]**.
3. Set the **[Power On after Power Failure]** to a proper value for your Nuvo-3100.

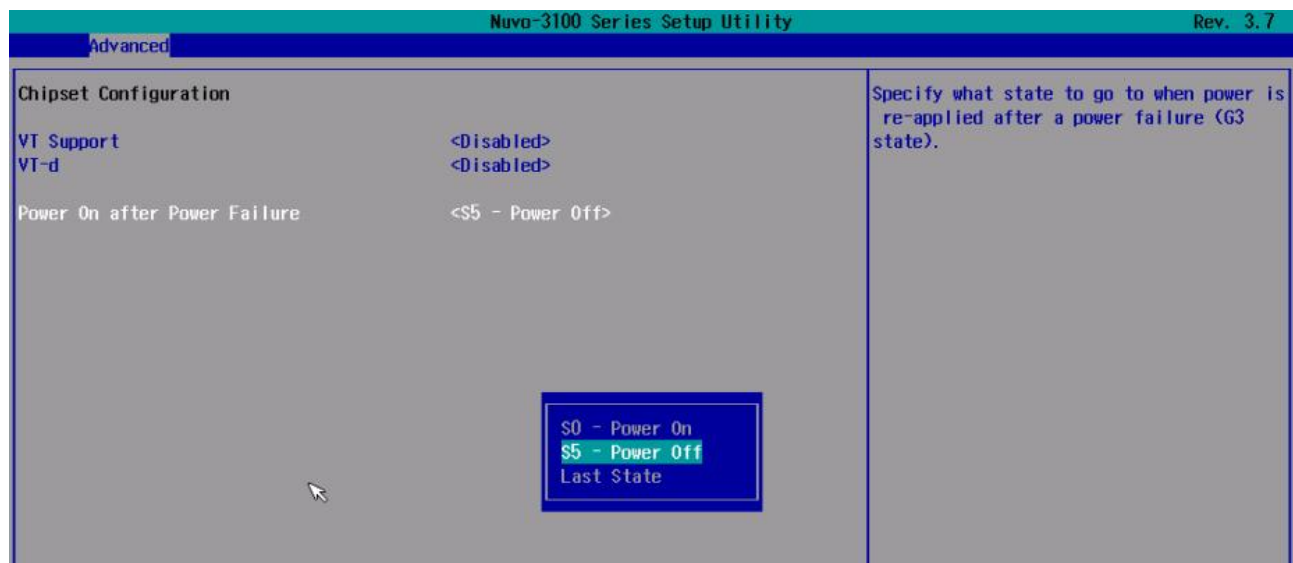

4.1.6 W_DISABLE# for Mini-PCle Sockets

Nuvo-3100 series feature two mini-PCle sockets and one mSATA socket for function expansion. According to PCI Express Mini Card Specification Rev. 2.0, two signals, W_DISABLE1# and W_DISABLE2#, are defined to enable/disable radio operation of add-on modules. Nuvo-3100 BIOS provides user-configurable options to control the W_DISABLE# signals for each mini-PCle/mSATA socket. Please note that most mini-PCle modules support PCI Express Mini Card Specification Rev. 1.2 only and therefore

To configure W_DISABLE# for each mini-PCle/mSATA socket:

1. When Nuvo-3100 boots up, press F2 to enter BIOS setup utility.
2. Go to **[Advanced]** → **[Mini-PCle Configuration]**.
3. Set the **[W_DISABLE1#]** and **[W_DISABLE2#]** to a proper value according to your application.

Note

1. As most mini-PCle modules support PCI Express Mini Card Specification Rev. 1.2 only, we suggest to set **[W_DISABLE1#]** as **[High]** and **[W_DISABLE2#]** as **[Low]** to minimize compatibility issue.

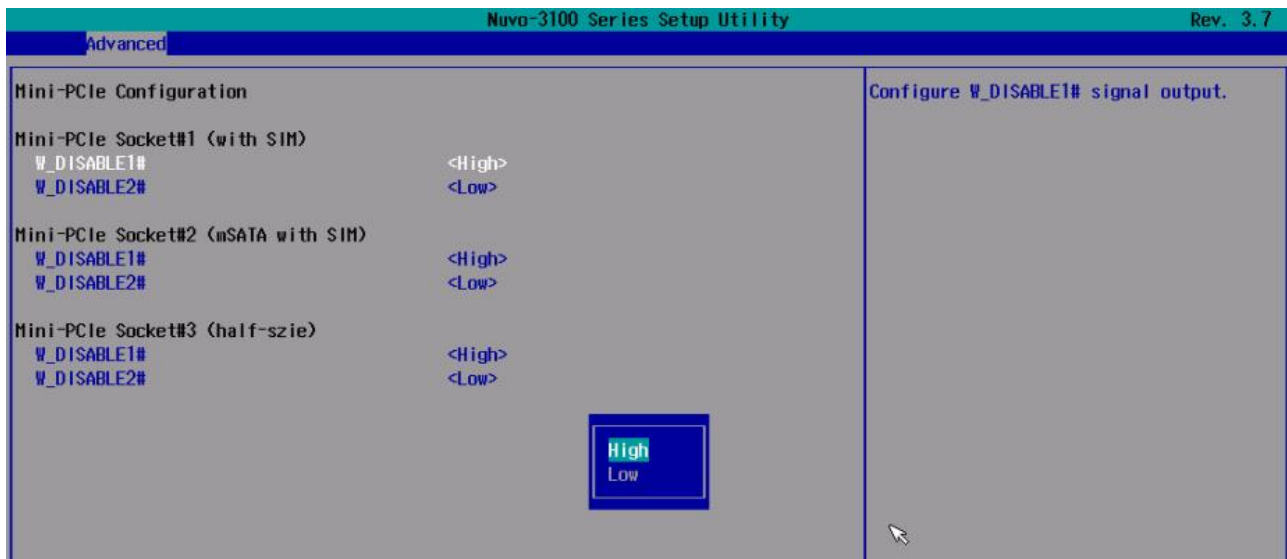

4.1.7 System Operating Mode

Nuvo-3100 series supports PGA-type CPU to offer greater flexibility for CPU selection. PGA-type processors are with higher CPU power, and therefore introduce higher performance and more heat. For adapting to various environments, Nuvo-3100 series features a unique BIOS option, **System Operating Mode**, to alter CPU power per user's preference. User can select a proper mode according to the environment of deployment (e.g. indoor/outdoor, with/without airflow ant etc.).

	Nuvo-3100 with i7-3610QE (PGA)	Nuvo-3100 with i5-3610ME (PGA)	i7-3517UE (BGA)
Maximal Performance	7407 / 50°C	4388 / 60°C	3449 / 70°C
Reduced Performance	5873 / 60°C	3896 / 70°C	
Extended Temperature	3471 / 70°C	3896 / 70°C	

CPU Benchmark Score v.s. Operating Temperature

To configure system operating mode:

1. When Nuvo-3100 boots up, press F2 to enter BIOS setup utility.
2. Go to **[Power]**.
3. Set the **[System Operating Mode]** to a proper mode according to your application.

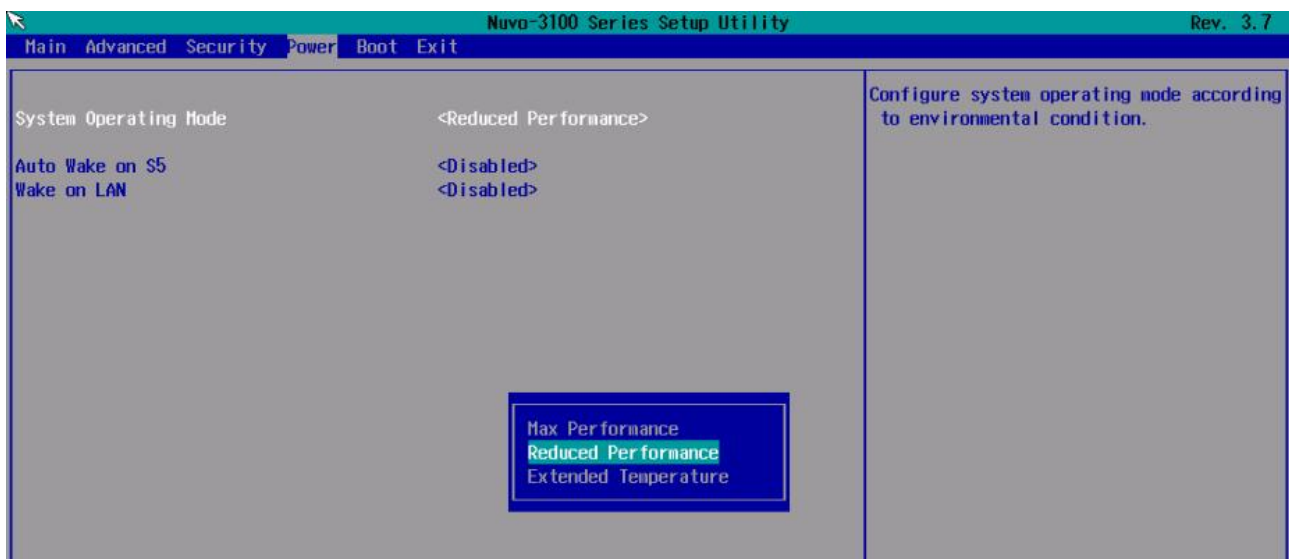

4.1.8 Wake on LAN Option

Wake-on-LAN (WOL) is a mechanism which allows you to turn on your Nuvo-3100 series via Ethernet connection. To utilize Wake-on-LAN function, you have to enable this option first in BIOS settings. Please refer to section 3.6.3 for instructions of using WOL function.

To enable/disable “Wake on LAN” option:

1. When Nuvo-3100 boots up, press F2 to enter BIOS setup utility.
2. Go to **[Power]**.
3. Enable/disable the **[Wake on LAN]** option according to your application.

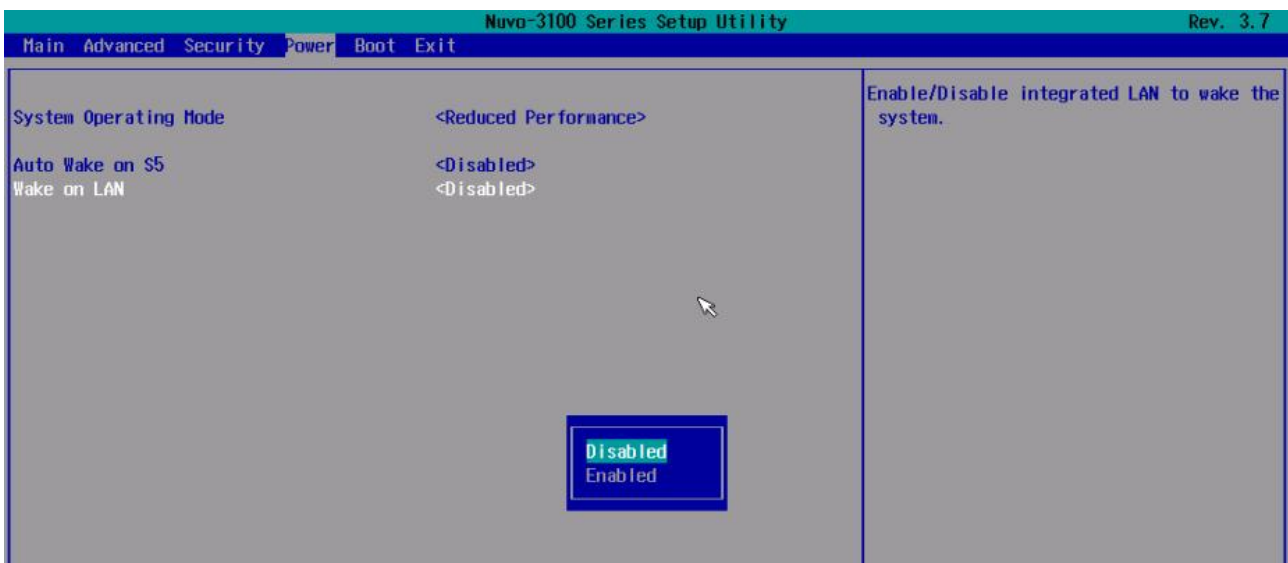

4.1.9 Watchdog Timer for Booting

The BIOS of Nuvo-3100 series has a useful feature which allows users to use the watchdog timer to secure the booting process. You can specify the timeout value for watchdog timer. Once the watchdog timer expires, the BIOS issues a reset command to initiate another booting process. You can also set the behavior of how to stop the watchdog timer. There are two options in BIOS menu, “*Automatically after POST*” and “*Manually after Entering OS*”. When “*Automatically after POST*” is selected, the BIOS automatically stop the watchdog timer after POST (Power-On Self Test) OK. When “*Manually after Entering OS*” is selected, it’s user’s responsibility to stop the watchdog timer when entering OS. This guarantees the system can always boot to OS, otherwise another booting process will be initiated. For information about programming watchdog timer, please refer to **Appendix A Using Watchdog Timer & Isolated DIO**.



To set the watchdog timer for boot in BIOS:

1. When Nuvo-3100 boots up, press F2 to enter BIOS setup utility.
2. Go to **[Boot]** menu.
3. Disable or select timeout value for **[WDT for Booting]** option.
4. Once you give a timeout value, the **[WDT Stop Option]** option appears. You can select *“Automatically after POST”* or *“Manually after Entering OS”*.

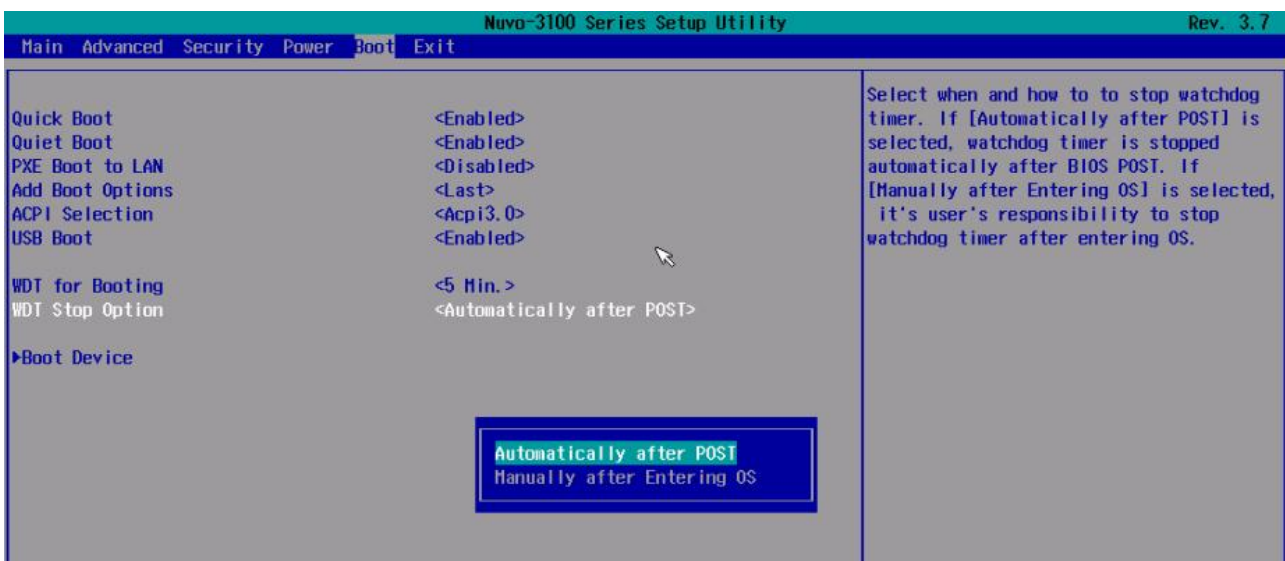
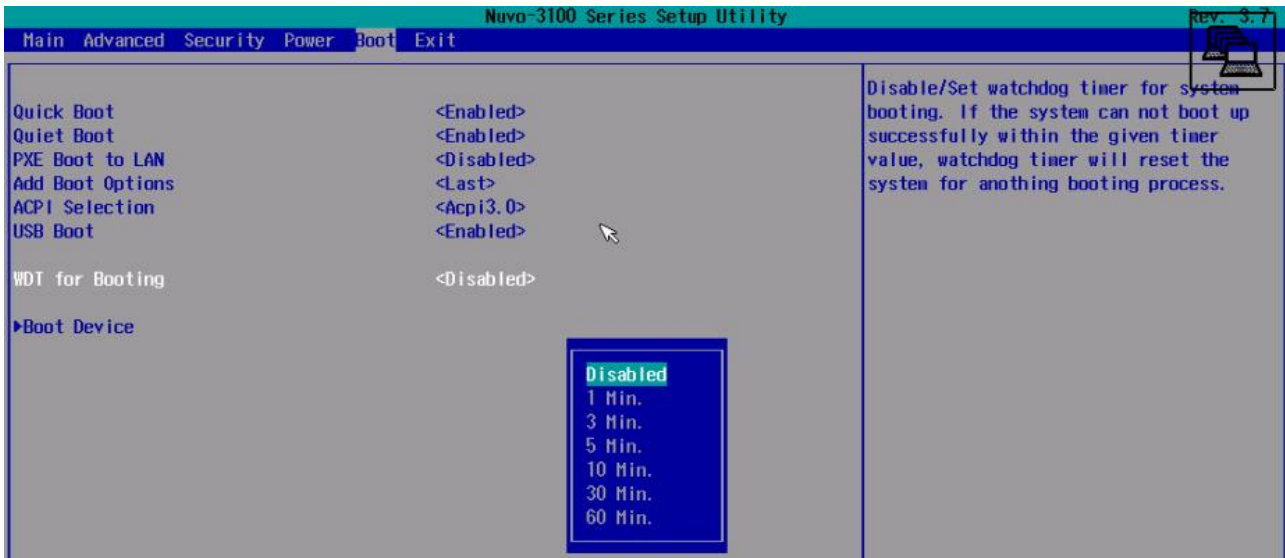

4.1.10 Select a Boot Device

When you have multiple bootable devices connected to your Nuvo-3100 (i.e. HDD, mSATA, USB flash disk, USB DVD-drive), you may need to select one of them as the boot device. There are two ways to select the device. You can either, press F12 when system boots up to go to Boot Manager and then select one of the devices, or select the boot device in BIOS settings.

To select a boot device in BIOS:

1. When Nuvo-3100 boots up, press F2 to enter BIOS setup utility.
2. Go to **[Boot] → [Boot Device]**.
3. The **[Boot Menu Type]** option decides whether to list all bootable devices connected to your Nuvo-3100 according to **[By Device]** or **[By Device Type]**. You can use F5/F6 or +/- to change the boot order of devices or device categories.

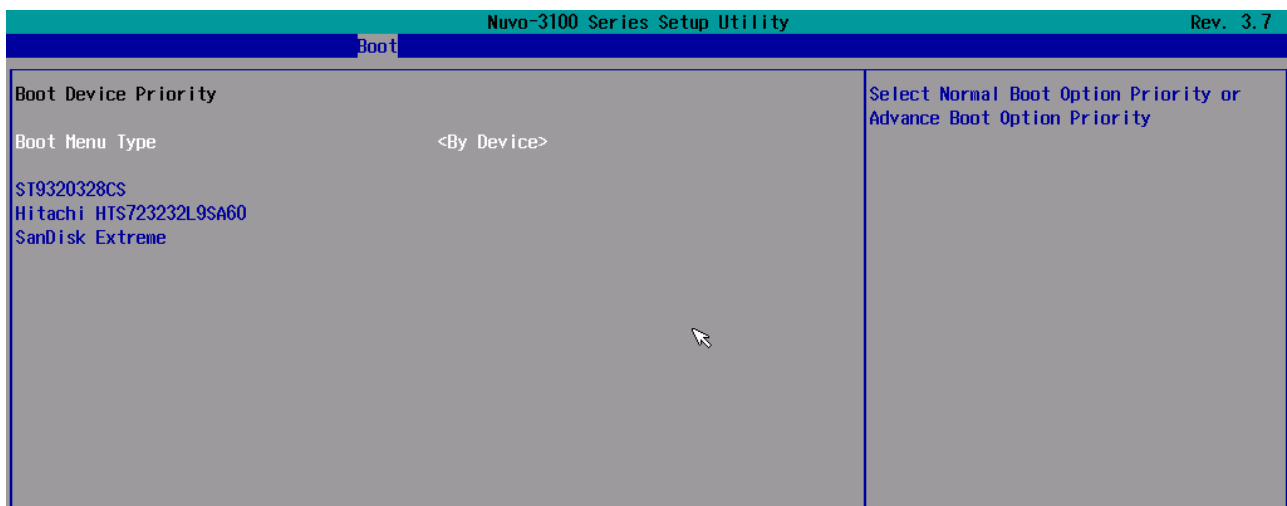

4.2 Configure AMT (Nuvo-3100VTC Only)

Intel® AMT (Active Management Technology) is a hardware-based technology for remotely managing target PCs via Ethernet connection. Nuvo-3100VTC supports AMT on its first Ethernet port. In prior to use AMT to remotely control Nuvo-3100VTC, you need to configure AMT password and network settings.

1. Make sure you have Ethernet connection on the first Ethernet port of Nuvo-3100VTC.

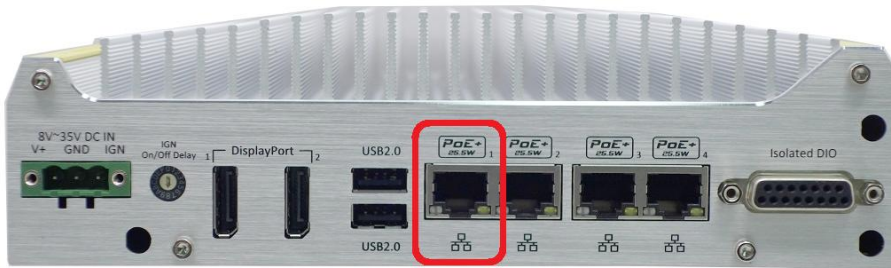

2. Press F10 when Nuvo-3100VTC boots up. A MEBx configuration page appears.

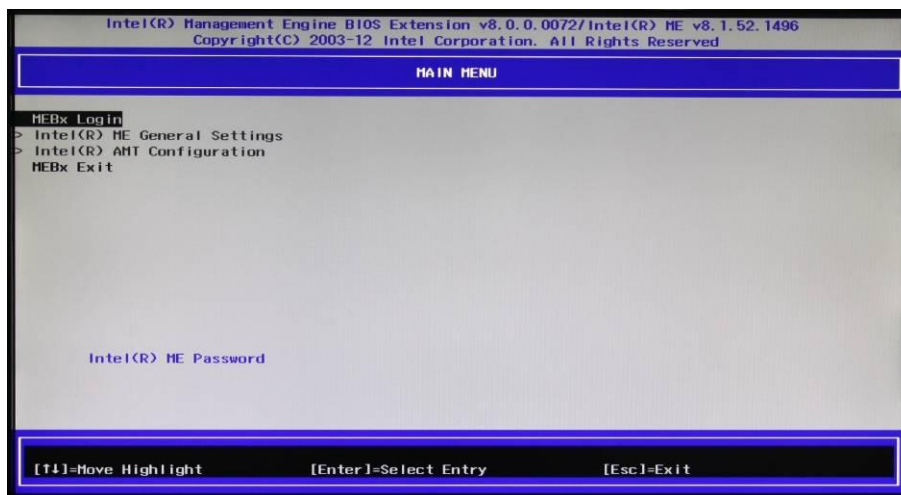

3. Select "MEBx Login" and you're asked for password. The default password is "admin".
4. For further AMT configuration, please refer to Intel® MEBX User Guide for Intel® 7 Series Chipset. You can find related information at <http://www.intel.com/support/motherboards/desktop/sb/CS-033768.htm>

4.3 Operating System Support

Nuvo-3100 series supports most operating system developed for Intel® x86 architecture. The following list contains the operating systems which have been tested in Neosys Technology Inc.

1. Microsoft Window XP 32-bit
2. Microsoft Window 7 32-bit
3. Microsoft Window 7 64-bit
4. Microsoft Window 8 32-bit
5. Microsoft Window 8 64-bit
6. Ubuntu (version later than 11.04 Desktop 64bit)*
7. Ubuntu (version later than 10.10 Desktop 32bit)*
8. Debian (version later than 6.0 64bit)*
9. Fedora 14 i386 32bit*
10. CentOS 6.4 32bit

**For Linux system, user may need to manually compile and install the driver for Intel I210 GbE controller if the driver is not embedded in kernel. You can visit Intel website for further information.*

Neosys will keep this list updated as we continuously test other operating systems with Nuvo-3100 series. Please contact us for the latest OS support list.



4.4 Driver Installation

Neosys Technology Inc. provides a very convenient utility in “Drivers & Utilities DVD” to allow the “One-Click” driver installation. This utility automatically detects your Windows operating system and installs all necessary drivers to your Nuvo-3100 series with just one mouse click.

4.4.1 Install All Drivers Using “One-Click” Driver Installation

1. Insert the “Drivers & Utilities DVD” into a USB DVD-drive attached to your Nuvo-3100 series. A setup utility launches and the following dialog appears.



2. Click on the “**Automatic Driver Installation**”. The setup utility will automatically detect your Windows operating system and install all necessary drivers. According to different versions of Windows, the installation process takes about 6~8 minutes. Once driver installation is done, the setup utility reboots your Windows and your system works normally afterward.

4.4.2 Install Drivers Manually

You can also manually install each driver for Nuvo-3100 series. Please refer to the following information about installing drivers for different operating system.

Windows XP SP3

The recommended driver installation sequence is

1. Chipset driver (x:\Driver_Pool\Chipset_7_Series\XP\infinst_autol.exe)
2. .NET Framework 3.5 (x:\Driver_Pool\DotNET35\XP\dotnetfx35.exe)
3. Graphics driver (x:\Driver_Pool\Graphics_3rd_i7_Vlv\XP\Setup.exe)
4. Audio driver (x:\Driver_Pool\Audio_ALC262\XP\Setup.exe)
5. 82579LM LAN driver
(x:\Driver_Pool\GbE_82574L\XP\APPS\PROSETDX\XP2K3_32\DxSetup.exe)
6. I210 LAN driver (x:\Driver_Pool\GbE_I210\XP\I210_XP_Install.exe)
7. ME driver (x:\Driver_Pool\ME_7_Series\ALL\Setup.exe)

Windows XP SP2

The recommended driver installation sequence is

1. Chipset driver (x:\Driver_Pool\Chipset_7_Series\XP\infinst_autol.exe)
2. Windows Installer 3.1
(x:\Driver_Pool\DotNET35\XP\WindowsInstaller-KB893803-v2-x86.exe)
3. .NET Framework 3.5 (x:\Driver_Pool\DotNET35\XP\dotnetfx35.exe)
4. Audio patch for HD audio
(x:\Driver_Pool\Audio_ALC262\XP\MSHDQFE\Win2K_XP\us\kb888111xpsp2.exe)
5. Graphics driver (x:\Driver_Pool\Graphics_3rd_i7_Vlv\XP\Setup.exe)
6. Audio driver (x:\Driver_Pool\Audio_ALC262\XP\Setup.exe)
7. 82579LM LAN driver
(x:\Driver_Pool\GbE_82574L\XP\APPS\PROSETDX\XP2K3_32\DxSetup.exe)
8. I210 LAN driver (x:\Driver_Pool\GbE_I210\XP\I210_XP_Install.exe)
9. ME driver (x:\Driver_Pool\ME_7_Series\ALL\Setup.exe)

Windows 7 32-bit

The recommended driver installation sequence is

1. Chipset driver (x:\Driver_Pool\Chipset_7_Series\Win7_8_ALL\SetupChipset.exe)
2. Graphics driver (x:\Driver_Pool\Graphics_3rd_i7_Vlv\Win7_8_32\Setup.exe)
3. Audio driver (x:\Driver_Pool\Audio_ALC262\Win7_8_ALL\Setup.exe)
4. LAN driver

(x:\Driver_Pool\GbE_I210\Win7_8_32\APPS\PROSETDX\Win32\DxSetup.exe)

5. USB 3.0 driver (x:\Driver_Pool\USB3_7_Series\Win7_ALL\Setup.exe)
6. ME driver (x:\Driver_Pool\ME_7_Series\Win7_8_AMT\Setup.exe)

Windows 7 64-bit

The recommended driver installation sequence is

1. Chipset driver (x:\Driver_Pool\Chipset_7_Series\Win7_8_ALL\SetupChipset.exe)
2. Graphics driver (x:\Driver_Pool\Graphics_3rd_i7_Vlv\Win7_8_64\Setup.exe)
3. Audio driver (x:\Driver_Pool\Audio_ALC262\Win7_8_ALL\Setup.exe)
4. LAN driver
(x:\Driver_Pool\GbE_I210\Win7_8_64\APPS\PROSETDX\Winx64\DxSetup.exe)
5. USB 3.0 driver (x:\Driver_Pool\USB3_7_Series\Win7_ALL\Setup.exe)
6. ME driver (x:\Driver_Pool\ME_7_Series\Win7_8_AMT\Setup.exe)

Windows 8 32-bit

The recommended driver installation sequence is

1. Chipset driver (x:\Driver_Pool\Chipset_7_Series\Win7_8_ALL\SetupChipset.exe)
2. Graphics driver (x:\Driver_Pool\Graphics_3rd_i7_Vlv\Win7_8_32\Setup.exe)
3. Audio driver (x:\Driver_Pool\Audio_ALC262\Win7_8_ALL\Setup.exe)
4. LAN driver
(x:\Driver_Pool\GbE_I210\Win7_8_32\APPS\PROSETDX\Win32\DxSetup.exe)
5. ME driver (x:\Driver_Pool\ME_7_Series\Win7_8_AMT\Setup.exe)

Windows 8 64-bit

The recommended driver installation sequence is

1. Chipset driver (x:\Driver_Pool\Chipset_7_Series\Win7_8_ALL\SetupChipset.exe)
2. Graphics driver (x:\Driver_Pool\Graphics_3rd_i7_Vlv\Win7_8_64\Setup.exe)
3. Audio driver (x:\Driver_Pool\Audio_ALC262\Win7_8_ALL\Setup.exe)
4. LAN driver
(x:\Driver_Pool\GbE_I210\Win7_8_64\APPS\PROSETDX\Winx64\DxSetup.exe)
5. ME driver (x:\Driver_Pool\ME_7_Series\Win7_8_AMT\Setup.exe)



Appendix A Using Watchdog Timer & Isolated DIO

Nuvo-3100 series provide a watchdog (WDT) timer function to ensure a more reliable system operation. The WDT is a hardware mechanism to reset the system if the watchdog timer is expired. Users can start the WDT and keeping resetting the timer to make sure the system or program is running. Otherwise, the system shall be reset.

Except for hardware watchdog function, an option of isolated digital I/O is available for extended range of applications. Nuvo-3100 series features 4x isolated DI channels and 4x isolated DO channels via a DSUB-15 connector. The digital I/O supports simple polling mode I/O access so users' program can read or write DIO channel(s) using this function library. Furthermore, it also features an enhanced mode of DI operation called "Change-of-State Interrupt". By detecting any change on digital input channel(s), an interrupt is generated according to a user-defined interrupt mask and level/edge setting, so user's program can react to the change.

In this document, we'll illustrate how to use the function library provided by Neosys to program the WDT and DIO functions. Currently, WDT & DIO driver library supports the following operating systems:

- Windows XP
- Windows 7 (32-bit & 64-bit)
- Windows 8 (32-bit & 64-bit)

For other OS support, please contact Neosys Technology for further information.



Install WDT and DIO Library

The WDT_DIO function library is delivered in the form of a setup package named **WDT_DIO_Setup.exe**. In prior to program WDT and DIO on Nuvo and POC series, you should execute the setup program and install the WDT and DIO library. Note you need WDT_DIO driver Rev. 2.06 or later to support WDT and DIO functions for Nuvo-3100 series.

1. Execute **WDT_DIO_Setup.exe**. The following dialog appears.

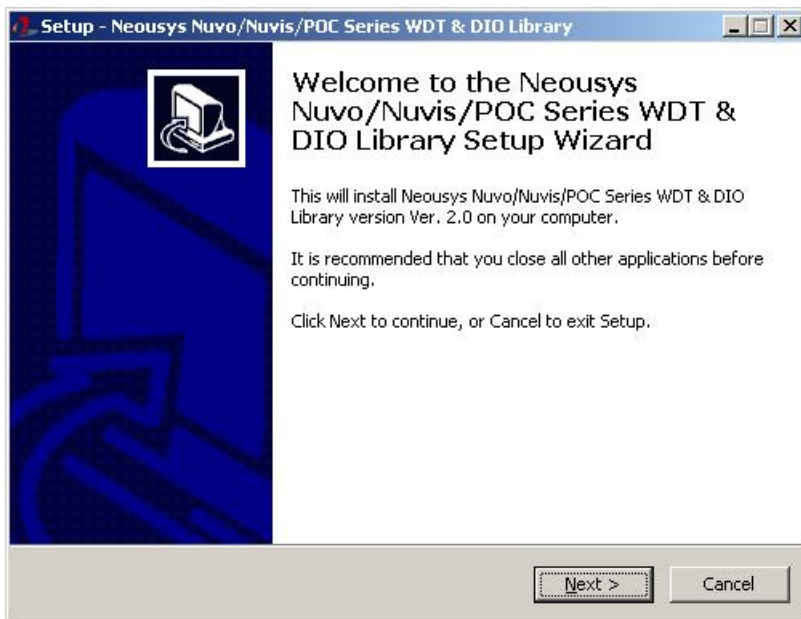

2. Click "Next >" and specify the directory of installing related files. The default directory is *C:\Neosys\WDT_DIO*.



3. Once the installation is finished, a dialog appears to prompt you to reboot the system. The WDT & DIO library will take effect after system rebooting.

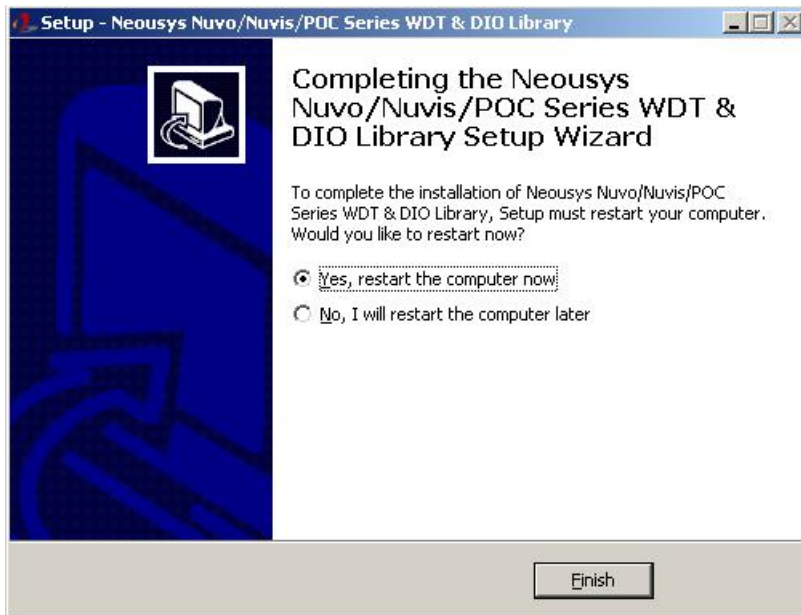

4. When you programming your WDT or DIO program, the related files are located in

- Header File: \Include
- Library File: \Lib
- Function Reference: \Manual
- Sample Code: \Sample\WDT_Demo (Watchdog Demo)
- \Sample\DIO_Demo (Polling I/O Demo)
- \Sample\COS_Demo (Change-of-State Interrupt Demo)
- \Sample\DTIO_Demo (DTIO Demo)
- \Sample\DTFO_Demo (Trigger Fan-out Demo)
- \Sample\PoE_Demo (PoE per-port Control Demo)

Using WDT Function

WDT Function Reference

InitWDT

Description

Initialize the WDT function. You should always invoke InitWDT() before set or start watchdog timer.

Parameter

None

Return Value

Returns TRUE if initialization successes, FALSE if initialization failed.

Usage

```
BOOL bRet = InitWDT();
```

SetWDT

Description

Set timeout value and unit for watchdog timer. When InitWDT() is invoked, a default timeout value of 255 seconds is assigned.

Parameter

tick

WORD value (1 ~ 65535) to indicate timeout ticks.

unit

BYTE value (0 or 1) to indicate unit of timeout ticks.

0 : unit is minute

1: unit is second

Return Value

If value of unit is correct (0 or 1), this function returns TRUE, otherwise FALSE.

Usage

```
WORD tick=255;
```

```
BYTE unit=1; //unit is second.
```

```
BOOL bRet = SetWDT(tick, unit); //timeout value is 255 seconds
```



StartWDT

Description

Start countdown of WDT. When WDT is started, the WDT LED indicator starts to blink in a frequency of 1Hz. If no ResetWDT() or StopWDT is invoked before WDT is counted to 0, the WDT expires and system resets.

Parameter

None

Return Value

If the timeout value is given in correct format, this function returns TRUE, otherwise FALSE.

Usage

```
BOOL bRet = StartWDT();
```

ResetWDT

Description

Reset the timeout value to the value given by SetWDT(). If no ResetWDT() or StopWDT is invoked before WDT is counted to 0, the WDT expires and system resets.

Parameter

None

Return Value

Always returns TRUE;

Usage

```
BOOL bRet = ResetWDT();
```

StopWDT

Description

Stop the countdown of WDT. When WDT is stopped, the WDT LED indicator stops blinking.

Parameter

None

Return Value

Always returns TRUE;

Usage



```
BOOL bRet = StopWDT();
```

Using DIO Function

Wiring for DIO

The digital input function of Nuvo-3100 series is implemented using a photo-coupler with an internally series-connected 2.4kΩ resistor. You need to provide a voltage to specify the logic high/low state. The input voltage for logic high is 5~24V, and the input voltage for logic low is 0~1.5V.

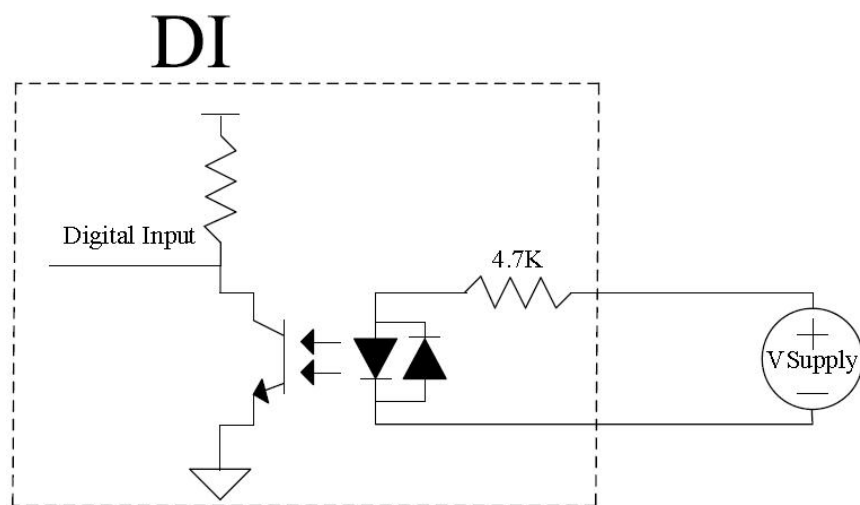

The digital output function of Nuvo-3100 series is implemented using Power MOSFET + Analog Device iCoupler® component. The DO channels are configured as NO (normally-open) configuration. When you turn on system, all DO channels have a deterministic state of logic 0 (circuit disconnected from GND return). When logic 1 is specified, MOSFET is activated and GND return path is established. The digital output function on Nuvo-3100 series supports sinking current connection. The following diagrams are the suggested wiring for DO:

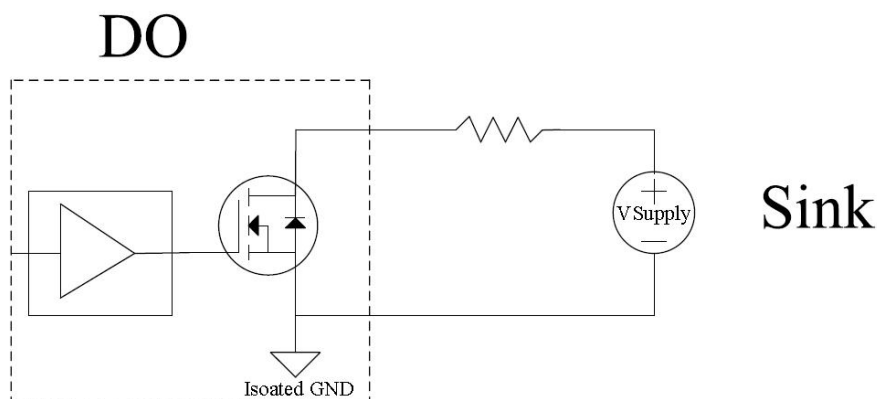

DIO Pin Definition

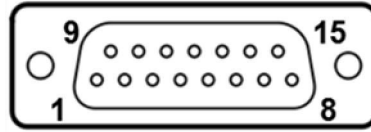

Pin#	Pin Definition	Pin#	Pin Definition
1	DI_0	9	DI_GND
2	DI_1	10	DI_2
3	DI_GND	11	DI_3
4	DO_GND	12	DO_GND
5	DO_0	13	DO_2
6	DO_1	14	DO_3
7	DO_GND	15	ISO_5V
8	VDD		

DIO Function Reference

InitDIO

Description

Initialize the DIO function. You should always invoke InitDIO() before write/read any DIO port/channel.

Parameter

None

Return Value

Returns TRUE if initialization successes, FALSE if initialization failed.

Usage

```
BOOL bRet = InitWDT();
```

DIReadLine

Description

Read a single channel of isolated digital input.

Parameter

ch

BYTE value specifies the DI channel to be read.

For Nuvo-3100 series, *ch* should be a value of 0 ~ 3.

Return Value

The status (TRUE or FALSE) of the specified DI channel.

Usage

```
BYTE ch=3; //DI channel #3
```

```
BOOL DIChValue = DIReadLine(ch); //read DI channel #3
```

DIReadPort

Description

Read the entire isolated digital input port (4 channels).

Parameter

None

Return Value

A WORD value indicates the status of DI port (4 DI channels, 0x00 ~ 0x0F).

Usage

```
WORD  DIPortValue = DIRedPort ();
```

DOWriteLine

Description

Write a single channel of isolated digital output.

Parameter

ch

BYTE value specifies the DO channel to be written.

For Nuvo-3100 series, *ch* should be a value of 0 ~ 3.

value

BOOL value (TRUE or FALSE) specifies the status of DO channel.

Return Value

None

Usage

```
BYTE  ch=3; //DI channel #3
```

```
BOOL  DOChValue=TRUE;
```

```
DOWriteLine(ch, DOChValue); //write DO channel #3 as TRUE
```

DOWritePort

Description

Write the entire isolated digital output port (4 channels).

Parameter

value

WORD value specifies the status of the DO port.

For Nuvo-3100 series, *value* should be a value of 0~15.

Return Value

None

Usage

```
WORD  DOPortValue=0x0C; //1100b
```

```
DOWritePort(DOPortValue); //write DO port as 1100b
```



DOWriteLineChecked

Description

Write a single channel of isolated digital output and read-back the value of DO register. Note that this function is not returned until the DO register is checked and identical to the written value.

Parameter

ch

BYTE value specifies the DO channel to be written.

For Nuvo-3100 series, *ch* should be a value of 0 ~ 3.

value

BOOL value (TRUE or FALSE) specifies the status of DO channel.

Return Value

None

Usage

BYTE `ch=3; //DI channel #3`

BOOL `DOChValue=TRUE;`

`DOWriteLineChecked(ch, DOChValue); //write DO channel #3 as TRUE`

DOWritePortChecked

Description

Write the entire isolated digital output port (8 channels) and check it has been done.

Note that this function is not returned until the write value has been checked the same with the device registry.

Parameter

value

WORD value specifies the status of the DO port.

For Nuvo-3100 series, *value* should be a value of 0~15.

Return Value

None

Usage

WORD `DOPortValue=0x0C; //1100b`

`DOWritePortChecked(DOPortValue); //write DO port as 1100b`





Using COS Function

SetupDICOS

Syntax

```
BOOL SetupDICOS(COS_INT_SETUP *lpSetup, DWORD cbSetup);
```

Description

Setup Digital-Input(DI) Change-of-State(COS) interrupt parameters.

Parameter

lpSetup [in]

A pointer to a **COS_INT_SETUP** structure that contains the COS configuration information for the DI device.

This data structure contains the following variables:

portMask

WORD value specifies the interrupt mask for corresponding channel(s).

edgeMode

WORD value specifies that interrupt is generated when level change (set to 0) or on rising/falling edge (set to 1) for the corresponding channel(s).

edgeType

WORD value specifies that interrupt is generated on rising edge (set to 0) or falling (set to 1) edge for corresponding channel(s). This value is neglected if *edgeMode* is set to 0 for the corresponding channel(s).

cbSetup [in]

The length of the structure, in bytes. The caller must set this member to sizeof(COS_INT_SETUP).

Return Value

Returns TRUE if setup successes, FALSE if setup failed.

Usage

```
COS_INT_SETUP  setup;
```

```
memset(&setup, 0, sizeof(setup));
```

```
setup.portMask = 0x0f; // enable ch.0~3
```

```
setup.edgeMode = 0; // level
```

```
setup.edgeType = 0x00; // Lo/Hi
```

```
BOOL  bRet = SetupDICOS(&setup, sizeof(setup));
```



RegisterCallbackDICOS

Syntax

```
BOOL RegisterCallbackDICOS(COS_INT_CALLBACK callback);
```

Description

Registers a callback function, which is called when the DICOS interrupt occurred.

Parameter

callback [in]

Specifies the callback function. The prototype for this function is described as follow.

```
void __stdcall callback_func(COS_INT_CALLBACK_ARG* arg);
```

Return Value

Returns TRUE if setup successes, FALSE if setup failed.

Usage

```
void __stdcall callback_func(COS_INT_CALLBACK_ARG* arg)
{
    printf("data=0x%02x, flag=0x%02x, seq=%02d\n",
        arg->portData, arg->intrFlag, arg->intrSeq);
}
BOOL bRet = RegisterCallbackDICOS(callback_func);
```

StartDICOS

Syntax

```
BOOL StartDICOS(void);
```

Description

Start DI Change-of-State interrupt

Parameter

None

Return Value

Returns TRUE if start procedure successes, FALSE if start procedure failed.

Usage

```
BOOL bRet = StartDICOS();
```



StopDICOS

Syntax

```
BOOL StopDICOS(void);
```

Description

Stop DI Change-of-State interrupt

Parameter

None

Return Value

Returns TRUE if stop procedure successes, FALSE if stop procedure failed.

Usage

```
BOOL bRet = StopDICOS();
```



DI COS Example

```

#include <stdio.h>
#include <stdlib.h>
#include <windows.h>
#include "WDT_DIO.h"

//Step 0, define a Change-of-State Interrupt callback function
void __stdcall callback_function(COS_INT_CALLBACK_ARG* arg)
{
    printf("data=0x%02x, flag=0x%02x, seq=%02d\n",
        arg->portData, arg->intrFlag, arg->intrSeq);
}

int main(int argc, char* argv[])
{
    //Step 1, initialize DIO library by invoking InitDIO()
    if ( ! InitDIO() )
    {
        printf("InitDIO --> FAILED\n");
        return -1;
    }
    printf("InitDIO --> PASSED\n");

    //Step 2, setup Change-of-State Interrupt mask and level/edge mode
    COS_INT_SETUP  setup;

    memset(&setup, 0, sizeof(setup));

    setup.portMask = 0x0f;    // 00001111b, enable ch.0~3
    setup.edgeMode = 0x00;    // generate interrupt on level change
    setup.edgeType = 0x00;    // rising/falling edge, only effective when edgeMode = 1

    if ( ! SetupDICOS(&setup, sizeof(setup)) )
    {
        printf("SetupDICOS --> FAILED\n");
        return -2;
    }
}

```



```

printf("SetupDICOS --> PASSED\n");

//Step 3, register the callback function
if ( ! RegisterCallbackDICOS(callback_function) )
{
    printf("RegisterCallbackDICOS --> FAILED\n");
    return -3;
}
printf("RegisterCallbackDICOS --> PASSED\n");

//Step 4, start the DI Change-of-State Interrupt
if ( ! StartDICOS() )
{
    printf("StartDICOS --> FAILED\n");
    return -4;
}
printf("StartDICOS --> PASSED\n");

printf("\npress any key to stop...\n");
system("pause >nul");

//Step 5, stop the DI Change-of-State Interrupt operation
if ( ! StopDICOS() )
{
    printf("StopDICOS --> FAILED\n");
    return -5;
}
printf("StopDICOS --> PASSED\n");

printf("\npress any key to exit...\n");
system("pause >nul");
return 0;
}

```

