

Neusys Technology Inc.

Nuvo-1000 Series

Intel® Core™ i7/i5 Fanless Embedded Controller

User's Manual

Rev. A2

Published May 10th, 2011



Contents

Disclaimer.....	5
Declaration of Conformity	5
FCC	5
CE	5
Copyright and Trademarks	5
Chapter 1 Introduction	6
1.1 Overview	6
1.2 Product Specification	7
Specification of Nuvo-1005S-620M.....	7
Specification of Nuvo-1003S-520M.....	8
Specification of Nuvo-1003S-4500P	9
Specification of Optional Isolated DIO.....	11
1.3 Supported CPU List	12
Chapter 2 Getting to know your Nuvo-1000.....	13
2.1 Unpacking your Nuvo-1000.....	13
2.2 Front Panel Function Description.....	14
Audio Jacks.....	14
PS/2 Keyboard and Mouse Connectors.....	14
USB Connectors	15
Gigabit Ethernet Port	15
DVI/HDMI Connector	16
VGA Connector	17
eSATA Ports.....	17
CF Socket	18
Power Button	18
LED Indicators	19
2.3 Rear Panel Function Description	20
DC Input Terminal Block.....	20
DC Jack	21
Gigabit Ethernet Ports.....	22
COM Ports	23
Optional Isolated DIO.....	24
2.4 “Pet-Door” HDD Assembly Description	25
2.5 Mechanical Dimension.....	26
Top View	26
Front View.....	26
Side View	27
Bottom View.....	28



Chapter 3	Getting Start	29
3.1	Install HDD and DDR3 SODIMM	29
	To install a DDR3 SODIMM module	30
	To install a HDD	30
3.2	Mount your Nuvo-1000	33
3.3	Connect DC power to you Nuvo-1000	35
	To connect DC power via the 4-pin pluggable terminal block.....	35
	To connect DC power via the DC jack.....	36
3.4	Power on your Nuvo-1000	37
	To power on Nuvo-1000 using the power button on the front panel	37
	To power on Nuvo-1000 using remote on/off control on the rear panel.....	37
	To power on Nuvo-1000 using Wake-on-LAN function.....	38
Chapter 4	BIOS and Driver	41
4.1	BIOS Settings	41
	COM1 Operating Mode.....	41
	SATA Controller Mode.....	42
	CPU Shutdown Temperature and Thermal Throttling.....	43
	Power On after Power Failure Option	44
	Wake-on-LAN Option	45
	Select a Boot Device.....	46
4.2	Operating System Support.....	47
4.3	Driver Installation	48
	To install all drivers using “One-Click” driver installation	48
	To install drivers manually	49
Appendix A	Using H/W Watchdog Timer.....	51
A.1	Before Programming WDT.....	51
A.2	Function Reference.....	51
	InitWDT	51
	SetWDT	52
	StartWDT	52
	ResetWDT	52
	StopWDT	53
Appendix B	Using Isolated DIO	54
B.1	Wiring for Isolated DIO.....	54
B.2	Before Programming DIO	55
B.3	Function Reference.....	56
	InitDIO.....	56
	DIReadLine	56
	DIReadPort	56
	DOWriteLine	57



DOWritePort.....57



Disclaimer

This manual is intended to be used as a practical and informative guide only and is subject to change without prior notice. It does not represent commitment from Neousys Technology Inc. Neousys shall not be liable for direct, indirect, special, incidental, or consequential damages arising out of the use of the product or documentation, nor for any infringements upon the rights of third parties, which may result from such use.

Declaration of Conformity

FCC

This equipment has been tested and found to comply with the limits for a Class A digital device, pursuant to part 15 of the FCC Rules. These limits are designed to provide reasonable protection against harmful interference when the equipment is operated in a commercial environment. This equipment generates, uses, and can radiate radio frequency energy and, if not installed and used in accordance with the instruction manual, may cause harmful interference to radio communications. Operation of this equipment in a residential area is likely to cause harmful interference in which case the user will be required to correct the interference at his own expense.

CE

The product(s) described in this manual complies with all applicable European Union (CE) directives if it has a CE marking. For computer systems to remain CE compliant, only CE-compliant parts may be used. Maintaining CE compliance also requires proper cable and cabling techniques.

Copyright and Trademarks

This document contains proprietary information protected by copyright. All rights are reserved. No part of this document may be reproduced by any mechanical, electronic, or other means in any form without prior written permission of the manufacturer.

Company/product names mentioned herein are used for identification purposes only and are trademarks and/or registered trademarks of their respective companies.



Chapter 1 Introduction

1.1 Overview

Boosting your computing engine to a new era! Incorporating Intel Core™ i7/i5 processor, the Nuvo-1000 controller offers extraordinary performance for arithmetic-intensive applications, while its fanless design provides superb reliability and durability.

Nuvo-1000 integrates versatile I/O interfaces in a compact chassis. It provides up to 5 Gigabit Ethernet ports and 2 eSATA ports, which are particularly useful for surveillance and security applications. The VGA+DVI/HDMI dual display accomplishes an easy way of high-resolution content output for image or media applications. In addition, Nuvo-1000 also features additional functions, such as mini-PCIe, optional isolated DIO and PCI-104 expansion bus, to fit a broader range of applications.

The fanless design of Nuvo-1000 gives it exceptional long-term durability and tolerance to vibration, and its -25 to 70 degrees operating temperature range provides a more reliable operation in various environments. For a quest of performance and reliability, Nuvo-1000 is the answer!



1.2 Product Specification

Specification of Nuvo-1005S-620M

System Core	
Processor	Intel® Core™ i7-620M (2.66 GHz, 4MB Cache)
Chipset	Intel® HM55 Platform Controller Hub
Graphics	Integrated Intel® HD Graphics Controller
Memory	1x 204-pin SO-DIMM socket, up to 4GB DDR3 1066MHz SDRAM
I/O Interface	
Ethernet	5x Intel® 82574L GbE ports
Video Port	1x DB-15 connector for analog RGB, supporting 2560x1600 resolution 1x DVI-D connector for DVI/HDMI output, supporting 1920x1080 (HDMI output) resolution, or 1600x1200 (DVI output) resolution
Serial Port	1x software-programmable RS-232/422/485 (COM1) 3x RS-232 (COM2 ~ COM4)
USB	6x USB 2.0 ports
KB/MS	1x PS/2 keyboard and 1x PS/2 mouse
Audio	1x Mic-in and 1x Speaker-out
Storage Interface	
SATA HDD	1x Internal SATA port for 2.5" HDD/SSD installation
eSATA	2x eSATA ports for storage expansion
CompactFlash	1x Type I CF socket
Expansion Bus	
Mini PCI-E	1x internal mini PCI Express socket with SIM socket
Power Supply	
DC Input	Built-in 8~26 VDC DC input
Input Connector	1x 4-pin pluggable terminal block with remote on/off control 1x DC jack (ø2.5) for AC/DC adapter input
Power Consumption	Maximal: 3.1A @ 19V (58.9W) under the following conditions <ul style="list-style-type: none"> ● 100% loading for i7-620M CPU ● 100% loading for 3D graphics ● 100% loading for 5x GbE ports
Mechanical	
Dimension	240 mm (W) x 195 mm (D) x 78 mm (H) (9.4" x 7.7" x 3.1")
Weight	2.7 kg (6 lbs) (including 2.5" HDD and DDR3 SODIMM)



Mounting	Wall-mount by mounting bracket
Environmental	
Operating Temperature	Ambient with air flow (0.5 m/s, or 1.8 Km/hr), 100% CPU loading * -25°C ~ 70°C ** Ambient without air flow, 100% CPU loading * -25°C ~ 60°C **
Storage Temperature	-40°C ~85°C
Humidity	10%~90% , non-condensing
Vibration	Operating, 5 Grms, 5-500 Hz, 3 Axes (w/ SSD, according to IEC60068-2-64)
Shock	Operating, 50 Grms, Half-sine 11 ms Duration (w/ SSD, according to
EMC	CE/FCC Class A, according to EN 61000-6-3 & EN 61000-6-1

* The CPU loading is applied using Intel® Thermal Analysis Tool. For detail testing criteria, please contact Neosys Technology

** For sub-zero operating temperature, a wide temperature HDD drive or Solid State Disk (SSD) is required.

Specification of Nuvo-1003S-520M

System Core	
Processor	Intel® Core™ i5-520M (2.4 GHz, 3MB Cache)
Chipset	Intel® HM55 Platform Controller Hub
Graphics	Integrated Intel® HD Graphics Controller
Memory	1x 204-pin SO-DIMM socket, up to 4GB DDR3 1066MHz SDRAM
I/O Interface	
Ethernet	3x Intel® 82574L GbE ports
Video Port	1x DB-15 connector for analog RGB, supporting 2560x1600 resolution 1x DVI-D connector for DVI/HDMI output, supporting 1920x1080 (HDMI output) resolution, or 1600x1200 (DVI output) resolution
Serial Port	1x software-programmable RS-232/422/485 (COM1) 3x RS-232 (COM2 ~ COM4)
USB	6x USB 2.0 ports
KB/MS	1x PS/2 keyboard and 1x PS/2 mouse
Audio	1x Mic-in and 1x Speaker-out
Storage Interface	
SATA HDD	1x Internal SATA port for 2.5" HDD/SSD installation
eSATA	2x eSATA ports for storage expansion
CompactFlash	1x Type I CF socket
Expansion Bus	



Mini PCI-E	1x internal mini PCI Express socket with SIM socket
Power Supply	
DC Input	Built-in 8~26 VDC DC input
Input Connector	1x 4-pin pluggable terminal block with remote on/off control 1x DC jack (ø2.5) for AC/DC adapter input
Power Consumption	Maximal: 2.8A @ 19V (53.2W) under the following conditions <ul style="list-style-type: none"> ● 100% loading for i5-520M CPU ● 100% loading for 3D graphics ● 100% loading for 3x GbE ports
Mechanical	
Dimension	240 mm (W) x 195 mm (D) x 78 mm (H) (9.4" x 7.7" x 3.1")
Weight	2.7 kg (6 lbs) (including 2.5" HDD and DDR3 SODIMM)
Mounting	Wall-mount by mounting bracket
Environmental	
Operating Temperature	Ambient with air flow (0.5 m/s, or 1.8 Km/hr), 100% CPU loading * -25°C ~ 70°C ** Ambient without air flow, 100% CPU loading * -25°C ~ 60°C **
Storage Temperature	-40°C ~85°C
Humidity	10%~90% , non-condensing
Vibration	Operating, 5 Grms, 5-500 Hz, 3 Axes (w/ SSD, according to IEC60068-2-64)
Shock	Operating, 50 Grms, Half-sine 11 ms Duration (w/ SSD, according to
EMC	CE/FCC Class A, according to EN 61000-6-3 & EN 61000-6-1

* The CPU loading is applied using Intel® Thermal Analysis Tool. For detail testing criteria, please contact Neosys Technology

** For sub-zero operating temperature, a wide temperature HDD drive or Solid State Disk (SSD) is required.

Specification of Nuvo-1003S-4500P

System Core	
Processor	Intel® Celeron™ P4500 (1.86 GHz, 2MB Cache)
Chipset	Intel® HM55 Platform Controller Hub
Graphics	Integrated Intel® HD Graphics Controller
Memory	1x 204-pin SO-DIMM socket, up to 4GB DDR3 1066MHz SDRAM
I/O Interface	
Ethernet	3x Intel® 82574L GbE ports



Video Port	1x DB-15 connector for analog RGB, supporting 2560x1600 resolution 1x DVI-D connector for DVI/HDMI output, supporting 1920x1080 (HDMI output) resolution, or 1600x1200 (DVI output) resolution
Serial Port	1x software-programmable RS-232/422/485 (COM1) 3x RS-232 (COM2 ~ COM4)
USB	6x USB 2.0 ports
KB/MS	1x PS/2 keyboard and 1x PS/2 mouse
Audio	1x Mic-in and 1x Speaker-out
Storage Interface	
SATA HDD	1x Internal SATA port for 2.5" HDD/SSD installation
eSATA	2x eSATA ports for storage expansion
CompactFlash	1x Type I CF socket
Expansion Bus	
Mini PCI-E	1x internal mini PCI Express socket with SIM socket
Power Supply	
DC Input	Built-in 8~26 VDC DC input
Input Connector	1x 4-pin pluggable terminal block with remote on/off control 1x DC jack (ø2.5) for AC/DC adapter input
Power Consumption	Maximal: 2.5A @ 19V (47.5W) under the following conditions <ul style="list-style-type: none"> ● 100% loading for P4500 CPU ● 100% loading for 3D graphics ● 100% loading for 3x GbE ports
Mechanical	
Dimension	240 mm (W) x 195 mm (D) x 78 mm (H) (9.4" x 7.7" x 3.1")
Weight	2.7 kg (6 lbs) (including 2.5" HDD and DDR3 SODIMM)
Mounting	Wall-mount by mounting bracket
Environmental	
Operating Temperature	Ambient with air flow (0.5 m/s, or 1.8 Km/hr), 100% CPU loading * -20°C ~ 60°C ** Ambient without air flow, 100% CPU loading * -20°C ~ 50°C **
Storage Temperature	-40°C ~85°C
Humidity	10%~90% , non-condensing
Vibration	Operating, 5 Grms, 5-500 Hz, 3 Axes (w/ SSD, according to IEC60068-2-64)
Shock	Operating, 50 Grms, Half-sine 11 ms Duration (w/ SSD, according to
EMC	CE/FCC Class A, according to EN 61000-6-3 & EN 61000-6-1

* The CPU loading is applied using Intel® Thermal Analysis Tool. For detail testing criteria, please contact Neosys Technology



** For sub-zero operating temperature, a wide temperature HDD drive or Solid State Disk (SSD) is required.

Specification of Optional Isolated DIO

Isolated Digital Input	
No. of Channel	8-CH Isolated Digital Input Channels
Logic Level	Logic High: 5 to 24V Logic Low: 0 to 1.5V
Isolated Voltage	2500 Vrms
Input Resistance	4.7k Ω
Isolated Digital Output	
No. of Channel	8-CH Isolated Digital Output Channels
Sink Current (per channel)	100 mA (sustained loading) 250 mA (peak loading)
Isolated Voltage	2500 Vrms
Output Type	Power MOSFET + Analog Device iCoupler®

1.3 Supported CPU List

Nuvo-1000 accepts a PGA-type Intel® i7/i5 processors via a rPGA988 CPU socket. The following processors have been tested by Neosys Technology Inc. for the compatibility with Nuvo-1000. Instead of i7-620M, i5-520M and Celeron P4500, You may also select other processor according to your consideration of cost and performance.

- i7-640M 2.8 GHz
- **i7-620M 2.66 GHz ***
- i5-580M 2.66 GHz
- i5-560M 2.66 GHz
- i5-540M 2.53 GHz
- **i5-520M 2.4 GHz ***
- i5-480M 2.66 GHz
- i5-460M 2.53 GHz
- i5-450M 2.4 GHz
- i5-430M 2.26 GHz
- i3-380M 2.53 GHz
- i3-370M 2.40 GHz
- i3-350M 2.26 GHz
- i3-330M 2.13 GHz
- **Celeron P4500 1.86 GHz ***
- Pentium P6000 1.86 GHz

*The processors with * are listed in Intel® Embedded Roadmap and with a 7-year life cycle support (2010~2016).*

Chapter 2 Getting to know your Nuvo-1000

2.1 Unpacking your Nuvo-1000

When you receive the package of Nuvo-1000 series, please check immediately if the package contains all the items listed in the following table. If any item is missing or damaged, please contact your local dealer or Neosys Technology Inc. for further assistance.

Item	Description	Qty
1	Nuvo-1005S or Nuvo-1003S fanless controller (According to the configuration you order, the Nuvo-1005S/1003S may contain HDD and DDR3 SODIMM. Please verify these items if necessary.)	1
2	Accessory box, which contains <ul style="list-style-type: none"> ● Neosys Drivers & Utilities DVD ● Wall-mounting bracket ● M4 screws for wall-mounting bracket ● Foot pad ● 4-pin pluggable terminal block ● HDD thermal pad (if HDD is not installed in Nuvo-1005S/1003S) 	1 2 4 4 1 1
3	Quick Installation Guide	1

2.2 Front Panel Function Description

On Nuvo-1000, all I/O connectors are located on front panel and rear panel. Most general computer connectors (i.e. audio, USB, keyboard/mouse, VGA and etc.) are placed on the front panel. In this section, we'll illustrate each I/O function on the front panel.

Audio Jacks

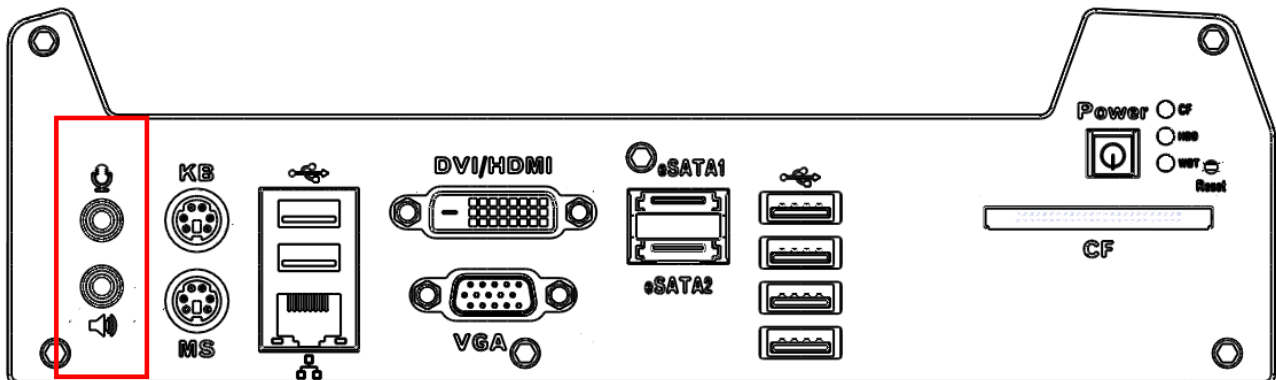

Nuvo-1000 provides audio function using Intel® High Definition Audio (built-in in HM55 PCH) and Realtek ALC262 codec. There are two audio jacks on the front panel. The pink one is used for microphone input, and the green one is used for speaker output. To utilize the audio function in Windows, you need to install corresponding drivers for both Intel® HM55 PCH chipset and Realtek ALC262 codec. Please refer to section 3.6 for information of driver installation.

PS/2 Keyboard and Mouse Connectors

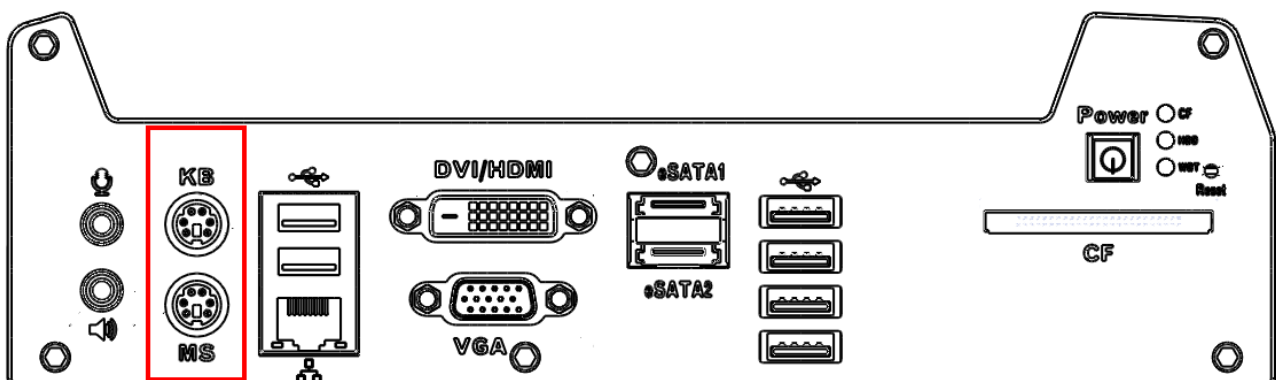

Support of legacy PS/2 keyboard and mouse on Nuvo-1000 is implemented using industrial-grade ITE8783 Super IO chip (-40 to 85°C). There are two 6-pin Mini-DIN connectors on the panel. The purple one is for PS/2 keyboard, and the green one is for PS/2 mouse.

USB Connectors

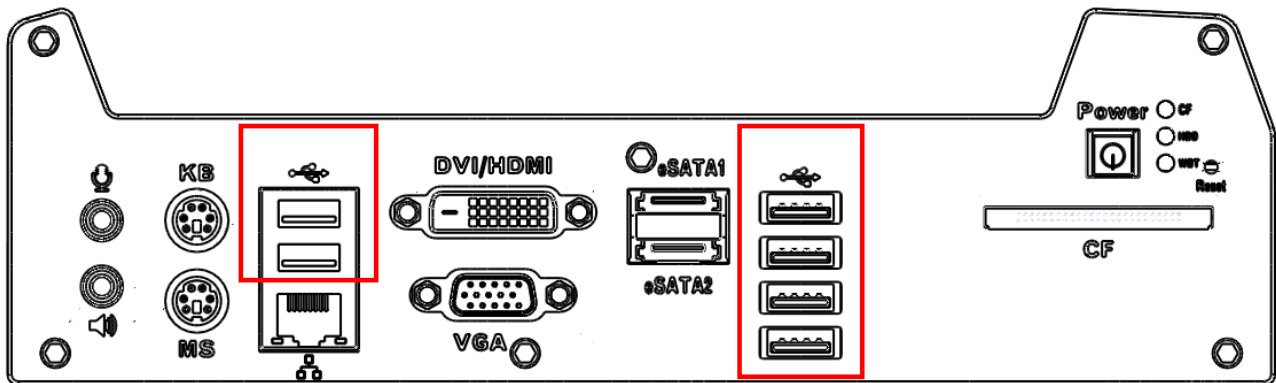

There are totally 6 USB ports on the front panel. By BIOS default, these USB ports are operated in EHCI (Enhanced Host Control Interface) mode and are compatible to USB 2.0, USB 1.1 and USB 1.0 devices. Legacy USB support is provided so you can use USB keyboard/mouse in DOS environment.

Gigabit Ethernet Port

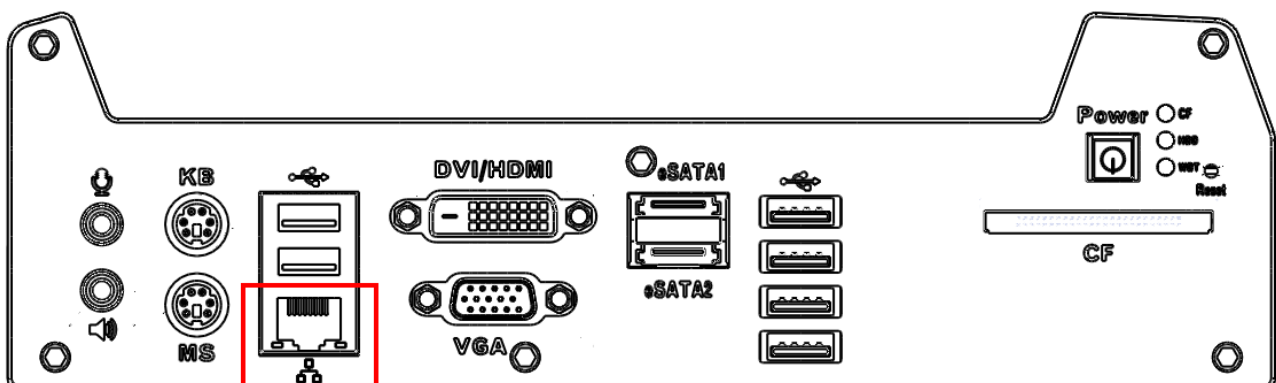

Nuvo-1000 controller offers 5 GbE ports (Nuvo-1005S) or 3 GbE ports (Nuvo-1003S) using Intel® 82574L Gigabit Ethernet controllers. Each port has one dedicated GbE controller and one dedicated PCI Express link to present maximal network performance. One of these GbE ports is located on the front panel. When plugging in the Ethernet cable, you can tell the Ethernet status and speed from the LED indicators on the RJ45 connector as following:

Active/Link LED

LED Color	Status	Description
Yellow	Off	Ethernet port is disconnected
	On	Ethernet port is connected and no data transmission
	Flashing	Ethernet port is connected and data is transmitting/receiving

Speed LED



LED Color	Status	Description
Green or Orange	Off	10 Mbps
	Green	100 Mbps
	Orange	1000 Mbps

To utilize the GbE port in Windows, you need to install corresponding driver for Intel® 82574L GbE controller. Please refer to section 3.6 for information of driver installation.

DVI/HDMI Connector

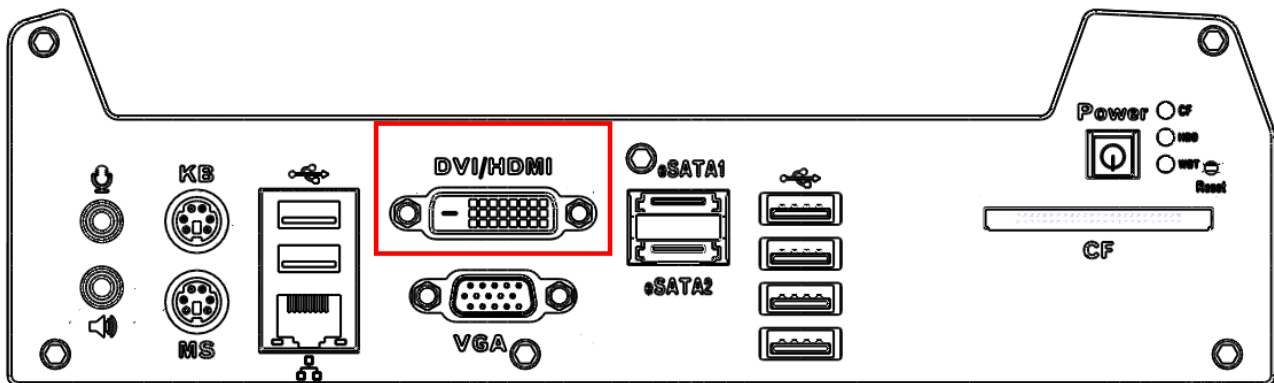

The DVI-D connector on the front panel supports both DVI and HDMI operation mode. This connector can either output DVI signals or HDMI signal. The DVI output mode supports up to 1600x1200 resolution and HDMI output mode supports up to 1920x1080 resolution. The DVI or HDMI mode is automatically selected according to the display device connected. You shall need a DVI-D to HDMI cable when connecting to a HDMI display device.



To utilize the VGA or DVI/HDMI output in Windows, you need to install corresponding graphics driver. Please refer to section 3.6 for information of driver installation.

VGA Connector

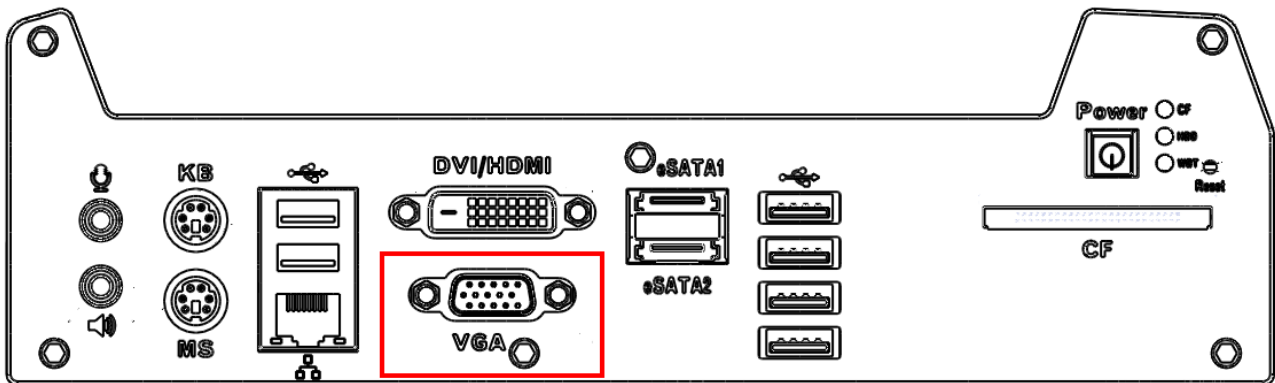

VGA connector is the most popular way to connect a display. The VGA output of Nuvo-1000 supports up to 2560x1600 resolution. By BIOS default, both VGA and DVI/HDMI output are enabled. To utilize the VGA or DVI/HDMI output in Windows, you need to install corresponding graphics driver. Please refer to section 3.6 for information of driver installation.

eSATA Ports

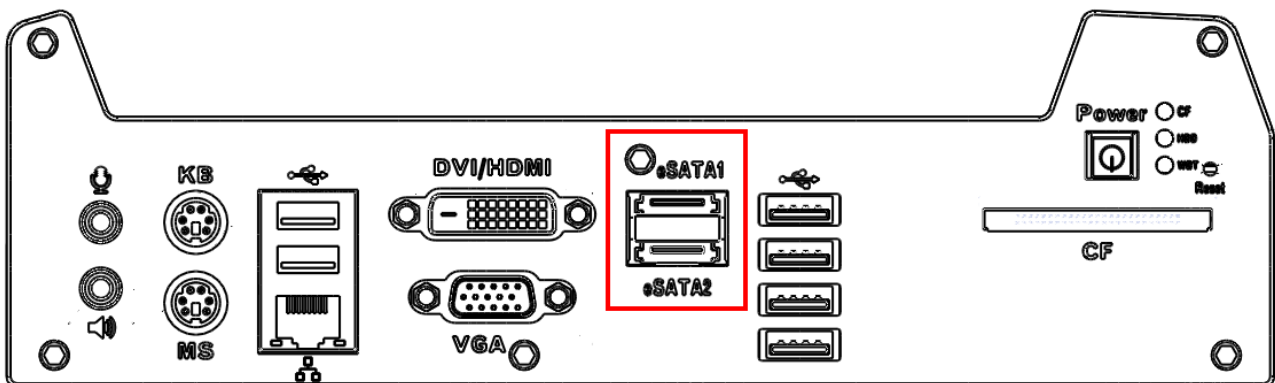

eSATA is a convenient way to extend storage devices. Devices with SATA interface, such as hard drive and CD/DVD drive, can be attached to the Nuvo-1000 controller via eSATA ports. In addition, eSATA interface supports hot-plug if SATA controller is configured as AHCI (Advanced Host Controller Interface) mode. Please refer to section 4.1 for setting SATA controller mode in BIOS.

CF Socket

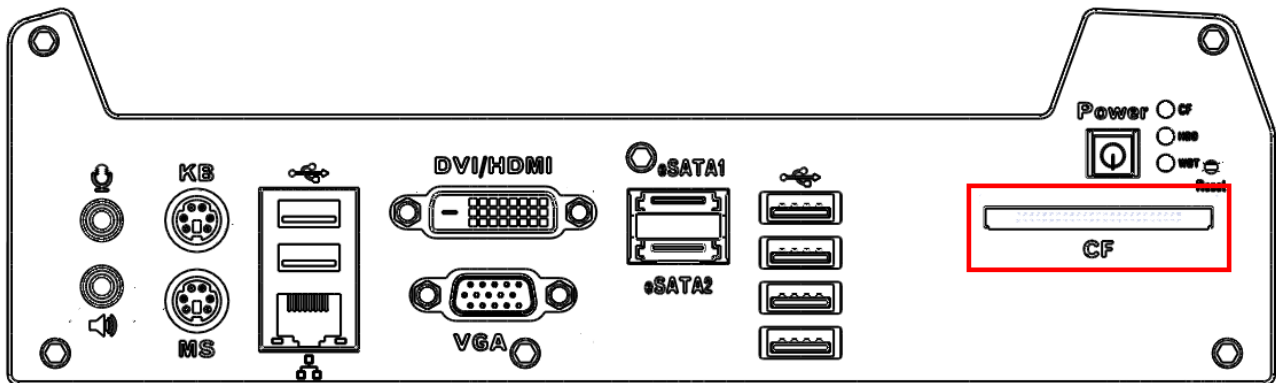

Nuvo-1000 provides a CF socket on the front panel for Type I CompactFlash card. It is implemented by a SATA-to-IDE bridge chip. For best compatibility, configuring SATA controller as IDE mode is highly recommended if you want to use CF card in your system. Please refer to section 4.1 for setting SATA controller mode in BIOS.

Power Button

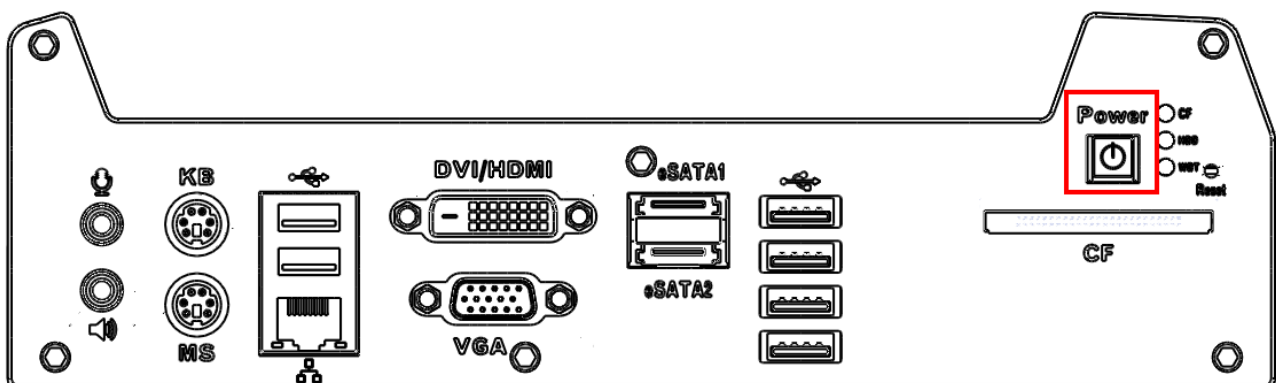

The power button is a non-latched switch with LED for ATX mode on/off operation. To turn on the Nuvo-1000, press the power button and the blue LED is lighted up. To turn off the Nuvo-1000, you can either issue a shutdown command in OS, or just simply press the power button. In case of system halts, you can press and hold the power button for 5 seconds to compulsorily shut down the system. Please note that a 5 seconds interval is kept by the system between two on/off operations (i.e. once turning off the system, you shall wait for 5 seconds to initiate another power-on operation).

LED Indicators

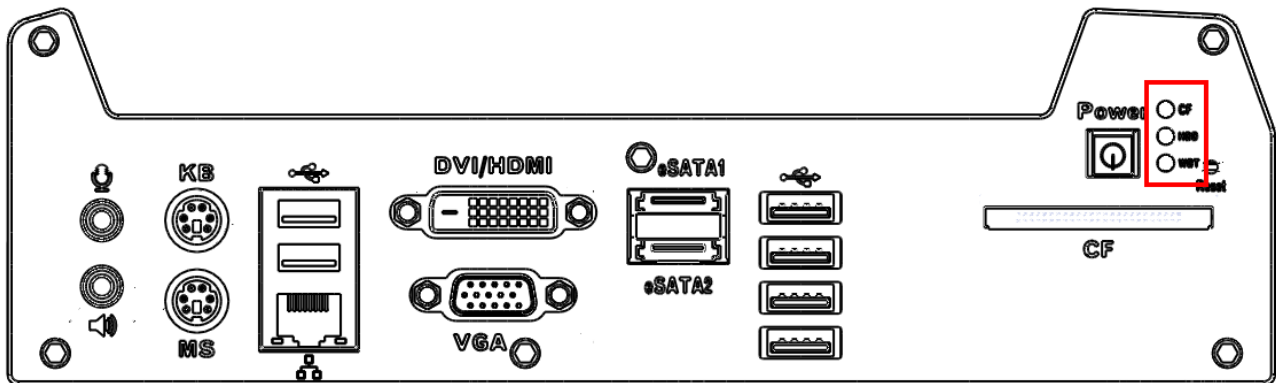

There are three LED indicators on the front panel: CF, HDD and WDT. The descriptions of these three LED are listed in the following table.

Indicator	Color	Description
CF	Green	CF indicator, flashing when CompactFlash card is active.
HDD	Red	Hard drive indicator, flashing when SATA hard drive is active.
WDT	Yellow	Watchdog timer indicator, flashing when watchdog timer is started.

2.3 Rear Panel Function Description

Power input, GbE ports, COM ports and optional isolated DIO are located on the rear panel. In this section, we'll illustrate connectors on the rear panel.

DC Input Terminal Block

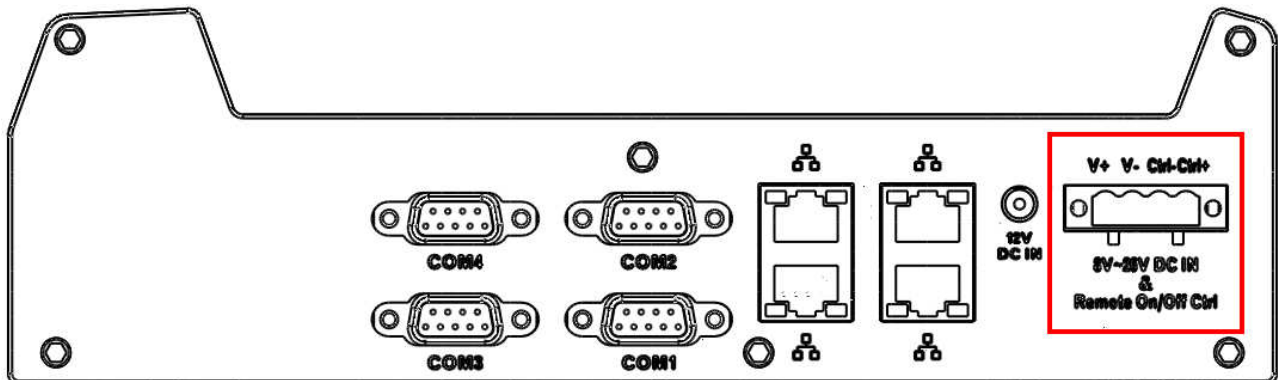

Nuvo-1000 allows a wide range of DC power input from 8 to 26V. It provides two ways for connecting DC power: a 4-pin pluggable terminal block or a DC jack. The 4-pin pluggable terminal block is fit for field usage where DC power is usually provided. And the screw clamping connection of terminal block gives a very reliable way of wiring the DC power. In addition to 2 pins for DC power input (V+, V-), the terminal block offers another 2 pins for remote on/off control (Ctrl+, Ctrl-). You can wire these two pins to an external switch to control system on/off in AT mode. The following table describes the pin definition of the pluggable terminal block. For detail information of connecting DC power and remote on/off control, please refer to section 3.3 and section 3.4.

Pin	Description
V+	Positive polarity of DC power input.
V-	Negative polarity of DC power input (usually power ground).
Ctrl+	Control pin to connect a latched on/off switch (polarity is negligible).
Ctrl-	Control pin to connect a latched on/off switch (polarity is negligible).

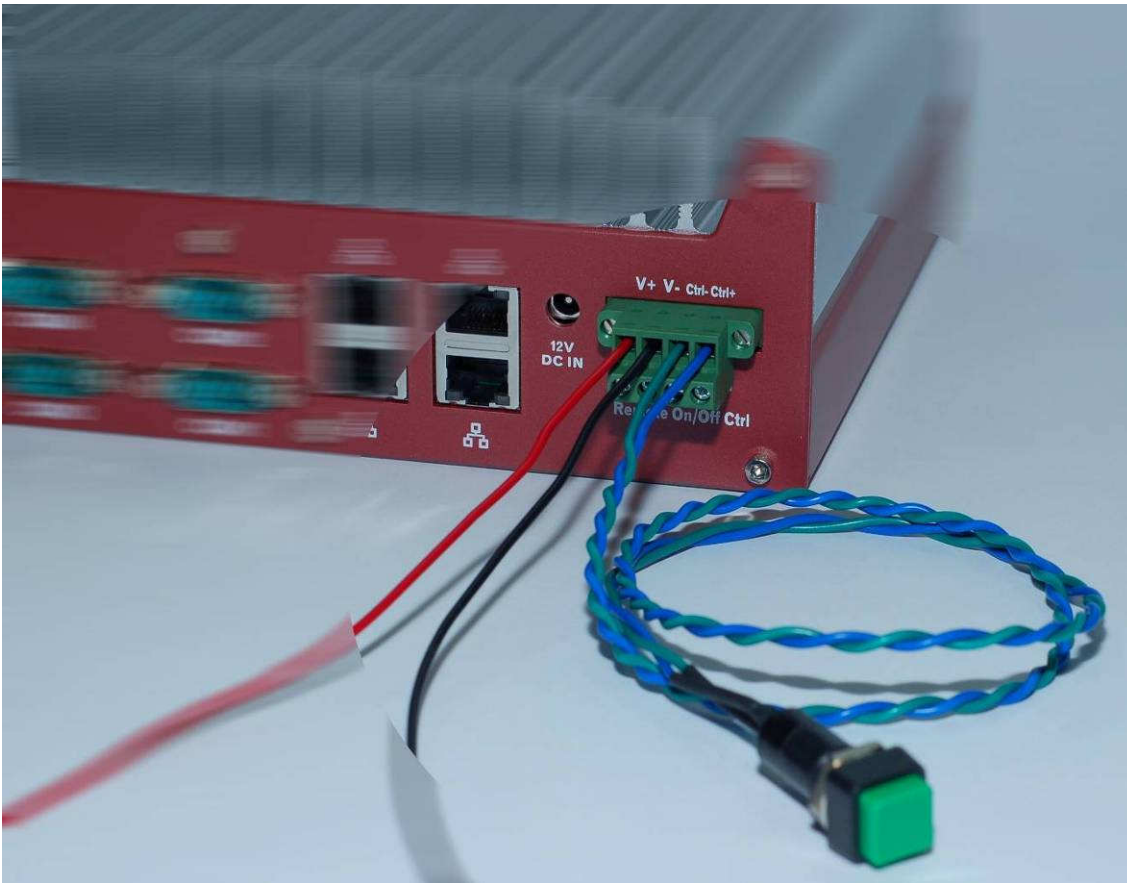

Caution

1. Please make sure the voltage of DC power is correct before you connect it to Nuvo-1000. Supplying a voltage over 26V will damage the system.
2. You should use either 4-pin pluggable terminal block or DC jack for DC power input. DO NOT supply power to both connectors at the same time.

DC Jack

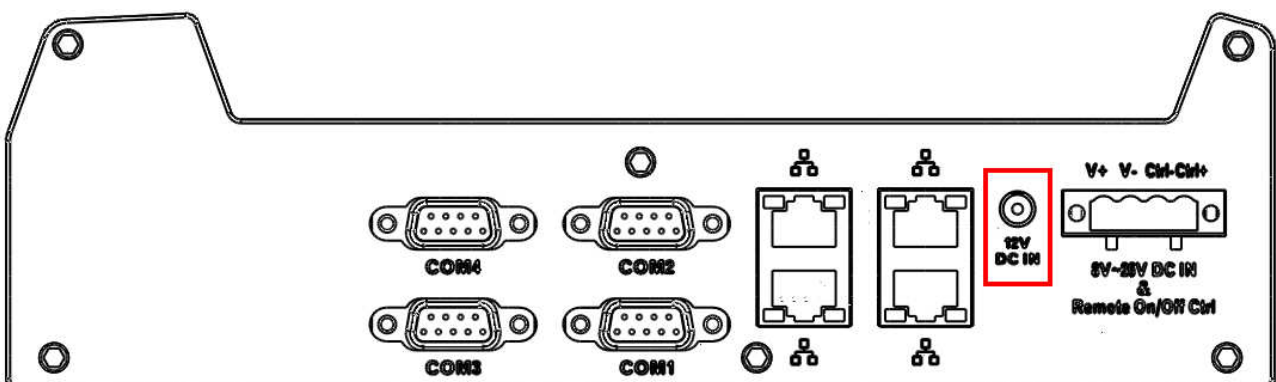

The DC jack on the rear panel provides another way for supplying DC power. It's convenient for indoor usage where AC power is usually available. The DC jack is designed to use with a 12V AC/DC adapter with a $\varnothing 2.5/5.5$ plug.



Caution

1. The rated voltage of DC jack is 16V. Supplying a voltage over 16V may cause safety issue.
2. You should use either 4-pin pluggable terminal block or DC jack for DC power input. DO NOT supply power to both connectors at the same time.

Gigabit Ethernet Ports

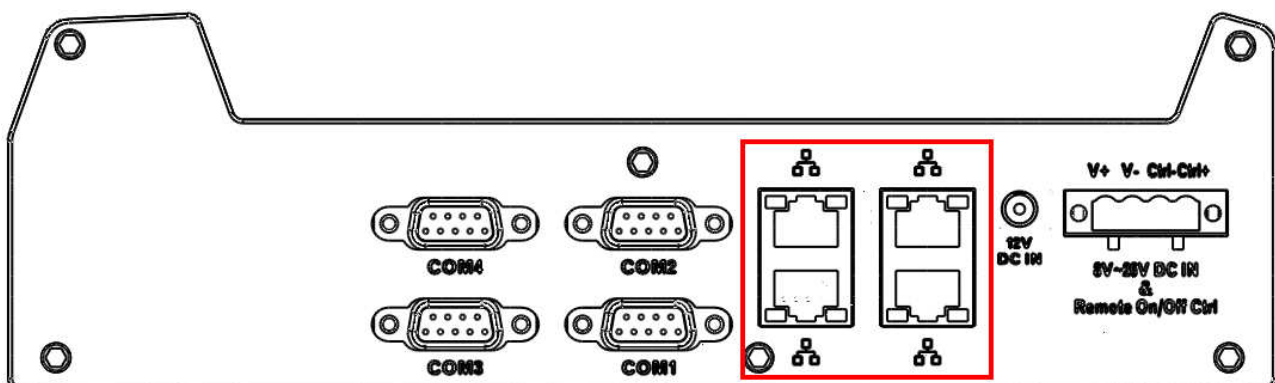

There are another 4 GbE ports (Nuvo-1005S) or 2 GbE ports (Nuvo-1003S) on the rear panel. These GbE ports are implemented using Intel® 82574L Gigabit Ethernet controllers. Each port has one dedicated GbE controller and one dedicated PCI Express link to present maximal network performance. When plugging in the Ethernet cable, you can tell the Ethernet status and speed from the LED indicators on the RJ45 connector as following:

Active/Link LED

LED Color	Status	Description
Yellow	Off	Ethernet port is disconnected
	On	Ethernet port is connected and no data transmission
	Flash	Ethernet port is connected and data is transmitting/receiving

Speed LED

LED Color	Status	Description
Green or Orange	Off	10 Mbps
	Green	100 Mbps
	Orange	1000 Mbps

To utilize the GbE port in Windows, you need to install corresponding driver for Intel® 82574L GbE controller. Please refer to section 4.3 for information of driver installation.

COM Ports

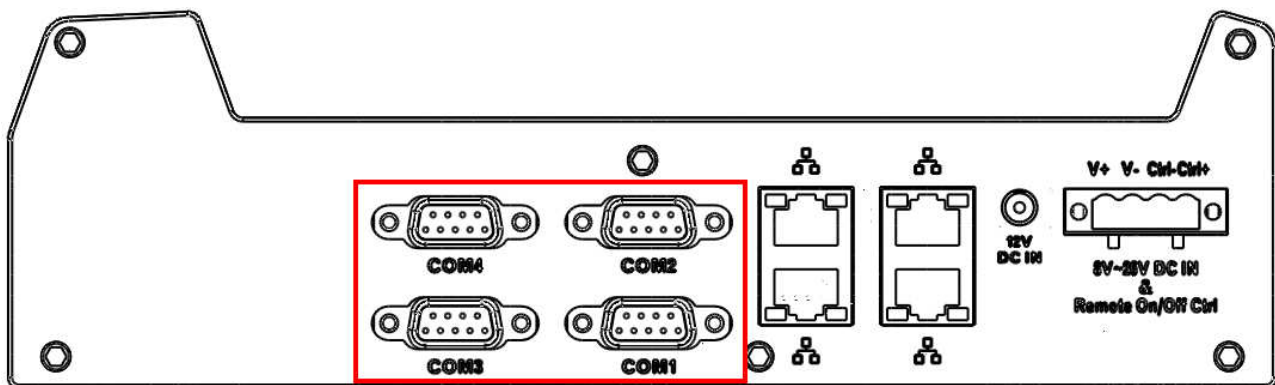

Nuvo-1000 provides 4 COM ports via 9-pin D-Sub male connectors for communicating with external devices. These COM ports are implemented using industrial-grade ITE8783 Super IO chip (-40 to 85°C) and provide up to 115200 bps baud rate. COM1 is a software-selectable RS-232/422/485 port and COM2/COM3/COM4 is RS-232 only. The operation mode of COM1 can be set in BIOS setup utility (refer to section 4.1 for detail). The following table describes the pin definition of COM ports.

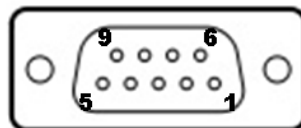

Pin#	COM1			COM2/COM3/COM4
	RS-232 Mode	RS-422 Mode	RS-485 Mode (Two-wire 485)	RS-232 Mode
1	DCD	422 RXD-		DCD
2	RX	422 RXD+		RX
3	TX	422 TXD+	485 TXD+/RXD+	TX

4	DTR			DTR
5	GND			GND
6	DSR			DSR
7	RTS	422 TXD-	485 TXD-/RXD-	RTS
8	CTS			CTS
9	GND			RI

Optional Isolated DIO

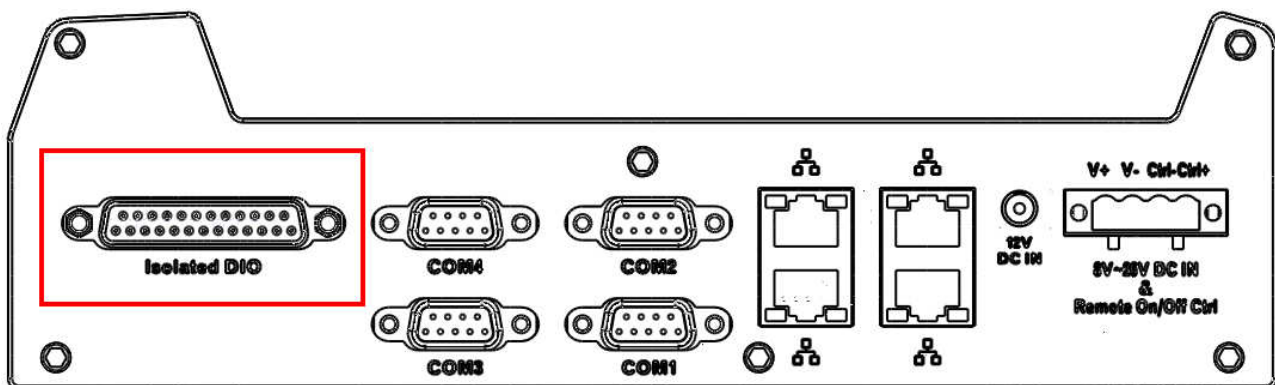

Nuvo-1000 offers an option of on-board 2500Vrms isolated DIO for extending application range. This option provides 8 channels of isolated digital input and 8 channels of isolated digital output via a 25-pin D-Sub female connector. The following table describes the pin definition of isolated DIO connector.

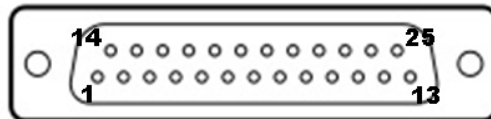

Pin#	Pin Definition	Pin#	Pin Definition
1	VDD	14	ISO_5V
2	DO_0	15	DO_GND
3	DO_3	16	DO_1
4	DO_GND	17	DO_2
5	DO_5	18	DO_4
6	DO_7	19	DO_6
7	DI_GND	20	DO_GND
8	DI_6	21	DI_GND
9	DI_1	22	DI_5
10	DI_GND	23	DI_3
11	DI_0	24	DI_7
12	DI_2	25	DI_GND
13	DI_4		

2.4 “Pet-Door” HDD Assembly Description

When you put the Nuvo-1000 upside down, you can see the “pet-door” on the bottom of the chassis. The “pet-door” design allows users to install or replace the memory module and hard drive quickly and easily. Please refer to section 3.1 for detailed instructions of installing HDD and DD3 SODIMM module.



2.5 Mechanical Dimension

Top View

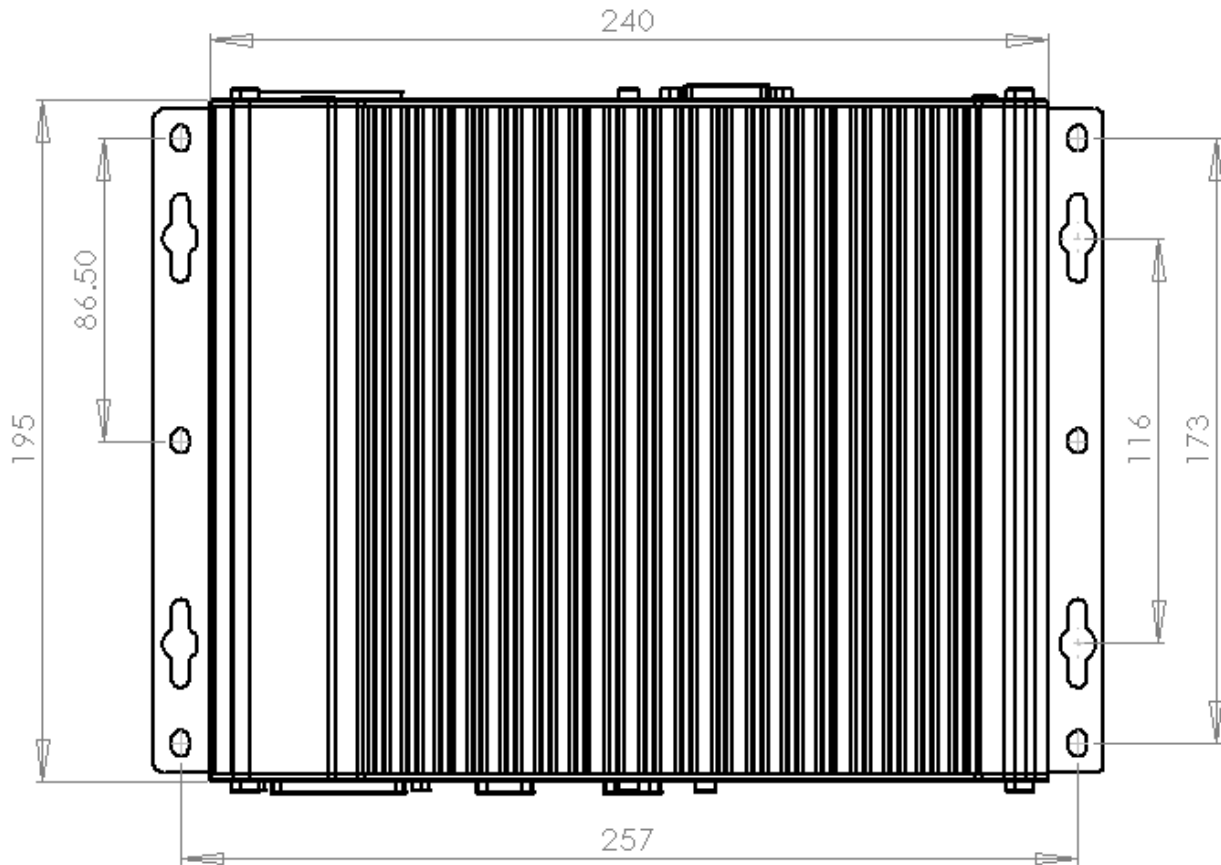

Front View

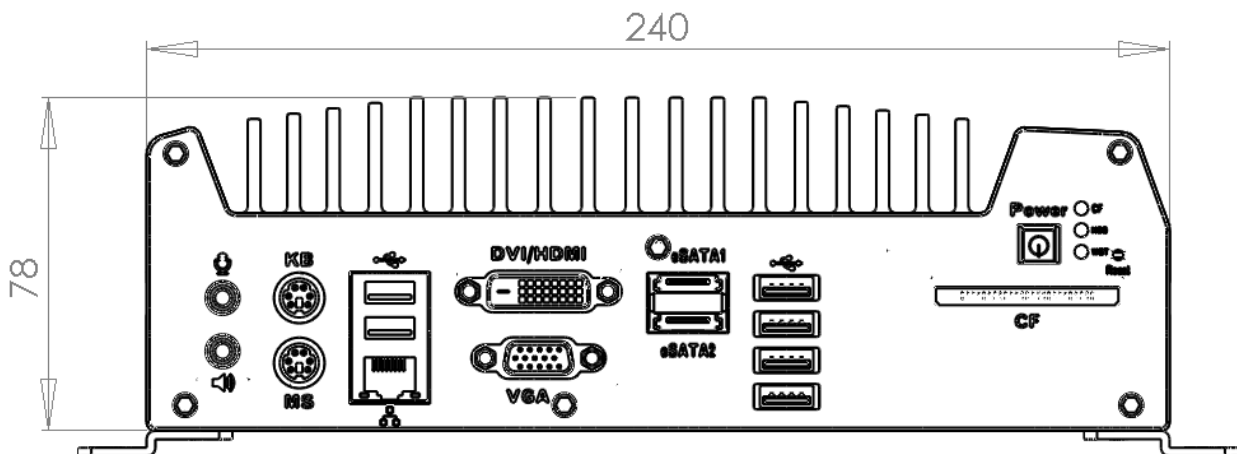

Side View

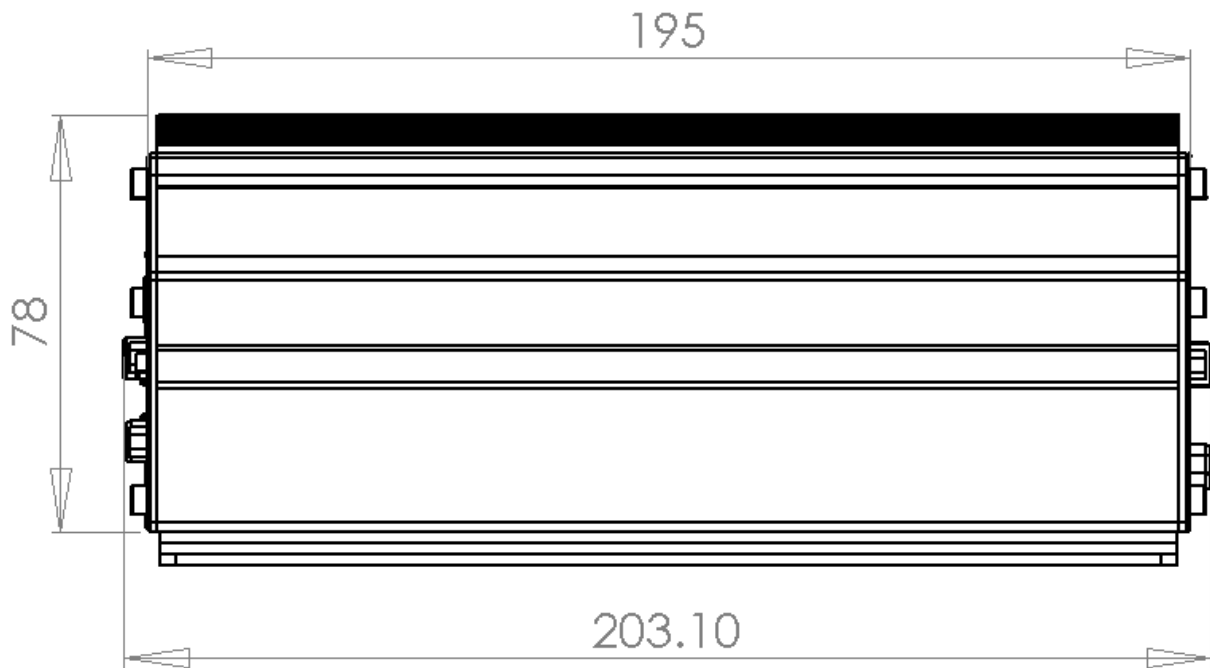

Bottom View

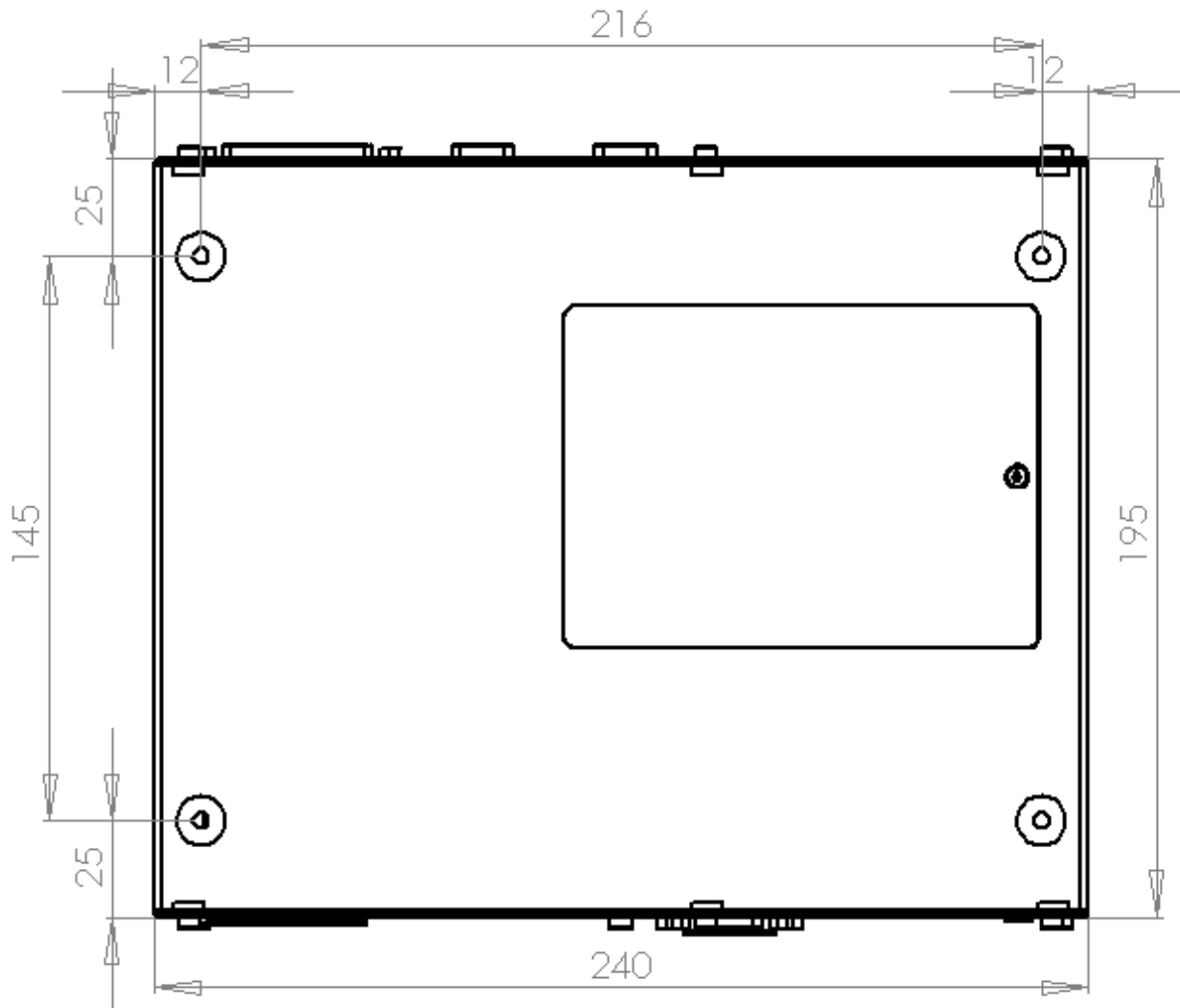

Chapter 3 Getting Start

3.1 Install HDD and DDR3 SODIMM

The Nuvo-1000 has a user-friendly “Pet-Door” design that allows users to install/replace HDD and DDR3 SODIMM module easily. By unscrewing just one screw, you can open the “Pet-Door” and access to the HDD and SODIMM.



You can install/replace HDD and DDR3 SODIMM by following the steps listed below.

1. Put the Nuvo-1000 upside down on a flat surface. You can see the “Pet-Door” exposed. Use a Philips screwdriver to loose the M3 flat-head screw on the “Pet-Door”.



2. Remove the “Pet-Door” and you can see a SATA cable and DDR3 SODIMM socket exposed.



To install a DDR3 SODIMM module

3. Tile the SODIMM module and insert it to the SODIMM socket. As it's firmly contacted with socket connectors, press it down until the clamps of the socket snap into the latching position of SODIMM module.

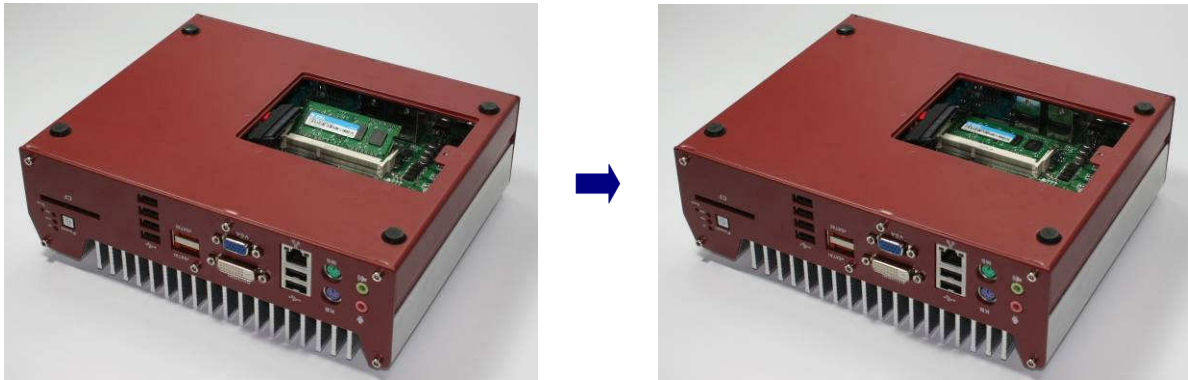

To install a HDD

4. Find the HDD bracket come with “Pet-Door”, M3 screws (4 pieces), and HDD thermal pad (1 piece) in the accessory box.



5. Put the HDD thermal pad on the center of HDD bracket.

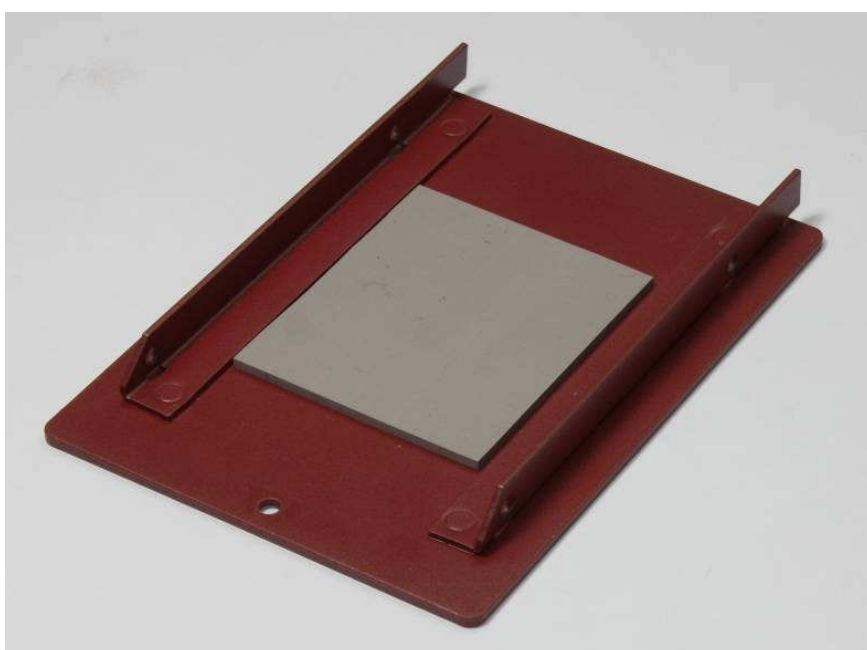

6. Place the HDD into the bracket and gently push it down to make it contact with thermal pad. Use a Philips screwdriver to fix the HDD with M3 screws. Please note that the HDD must be placed in the right direction as below.



7. Pull out the SATA cable inside the chassis and connect it to HDD.



8. Tilt the HDD assembly and insert the wedge of HDD bracket to the bottom cover. Once it's firmly wedged, push it down and fix it using a M3 flat-head screw.



3.2 Mount your Nuvo-1000

Nuvo-1000 is shipped with wall-mount brackets. You can mount your Nuvo-1000 on the wall by following the steps listed below.

1. Find your wall-mounts brackets (2 pieces) and M4 screws (4 pieces) in the accessory box.



2. Put the Nuvo-1000 upside down on a flat surface. 4 screw holes for M4 screws exposed on the bottom cover.
3. Fix two wall-mount brackets to the chassis with four M4 screws using a Philips screwdriver.



4. Now you can mount your Nuvo-1000 on the wall. For best efficiency of heat dissipation, please mount Nuvo-1000 in a right direction.

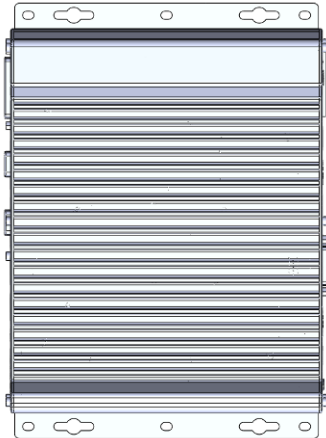
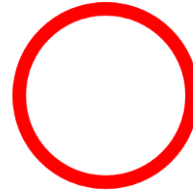
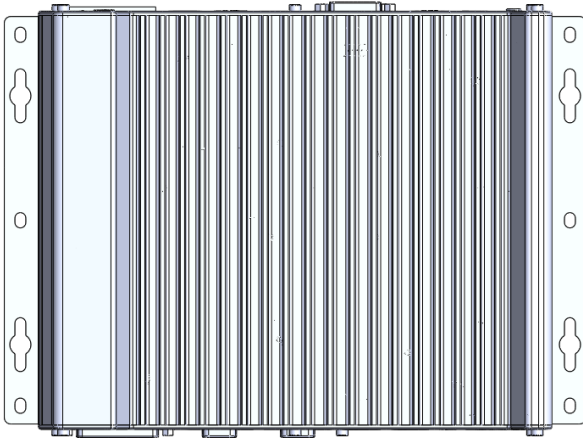

3.3 Connect DC power to you Nuvo-1000

There are two connectors on the rear panel you can use for DC power input: a 4-pin pluggable terminal block and a DC jack. The 4-pin pluggable terminal block accepts 8~26V DC input and the DC jack accepts 12V DC input.

Caution

1. Please make sure the voltage of DC power is correct before you connect it to Nuvo-1000. Supplying a voltage over 26V will damage the system.
2. You should use either 4-pin pluggable terminal block or DC jack for DC power input. DO NOT supply power to both connectors at the same time.

To connect DC power via the 4-pin pluggable terminal block

1. Make sure the external DC power supply is power off or disconnected before wiring.
2. Locate the 4-pin pluggable terminal block in the accessory box. Note that the terminal block fits the wires with a gauge of 12~24 AWG.
3. Carefully identify the positive and negative contacts of your DC power supply and pluggable terminal block. The polarities between DC power supply and terminal block must be positive (+) to positive (+) and negative (-) to negative (-).

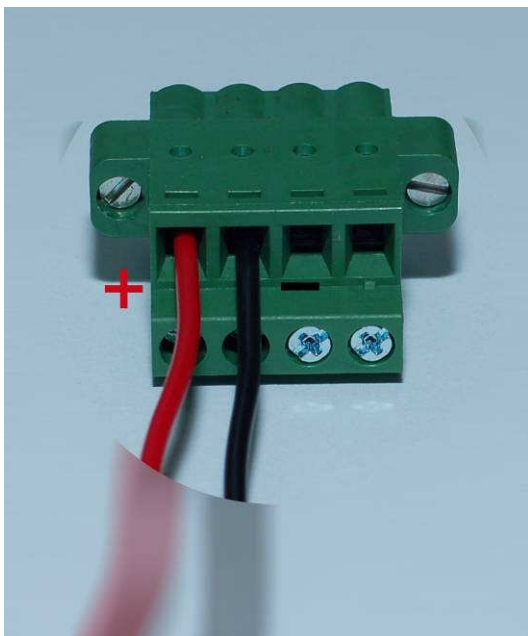

4. Insert the wires to correct contacts of pluggable terminal block and tighten clamping screws using a Philips screwdriver.
5. Firmly plug the terminal block into a receptacle on the rear panel, and tighten the captive screws using a Slotted screwdriver.



To connect DC power via the DC jack

1. Find your AC-DC adapter with a matched DC plug. The DC jack on the rear panel only accepts a DC plug with $\varnothing 2.5\text{mm}/5.5\text{mm}$ (inner diameter of 2.5mm and outer diameter 5.5mm).
2. Make sure the AC-DC adapter is off before you connect the DC plug to you Nuvo-1000.
3. Plug the AC-DC adapter into the DC jack on the rear panel and push it to the end. The DC plug shall stay firmly with the DC jack.



3.4 Power on your Nuvo-1000

For better flexibility of operation, Nuvo-1000 provides three alternatives can be used to power on your Nuvo-1000. You can turn on your Nuvo-1000 by pressing the power button, using an external latched on/off switch, or by sending a special LAN packet. In this section, we illustrate these three ways to power on your Nuvo-1000.

To power on Nuvo-1000 using the power button on the front panel

This is the simplest way to turn on your Nuvo-1000. The power button on the front panel is a non-latched switch and behaves an ATX-mode on/off control. As DC power is connected, push the power button and then system is on as well as the blue LED of power button is on. Push the button when system is on can turn off the system. If your operating system supports ATX power mode (i.e. Microsoft Windows or Linux), push the power button causes a pre-defined system behavior, such as shutdown or hibernation.

To power on Nuvo-1000 using remote on/off control on the rear panel

In addition to accept DC power (V+, V-), the 4-pin pluggable terminal block provides two pins (Ctrl+, Ctrl-) for behaving AT-mode remote on/off control. Please follow the steps listed below to use the remote on/off control function.

1. When Nuvo-1000 boots up, press F2 to enter BIOS setup utility.
2. Enter the **[Advanced]** → **[Chipset Configuration]** BIOS setting menu.
3. Configure the **[Power On after Power Failure]** BIOS option as **[S0 - Power On]**. This setting allows the system to turn on after external DC power is connected. Please refer to section 4.1 for the instruction of configuring this option.
4. Connect a latched switch to Ctrl+ and Ctrl-. Polarity is negligible.

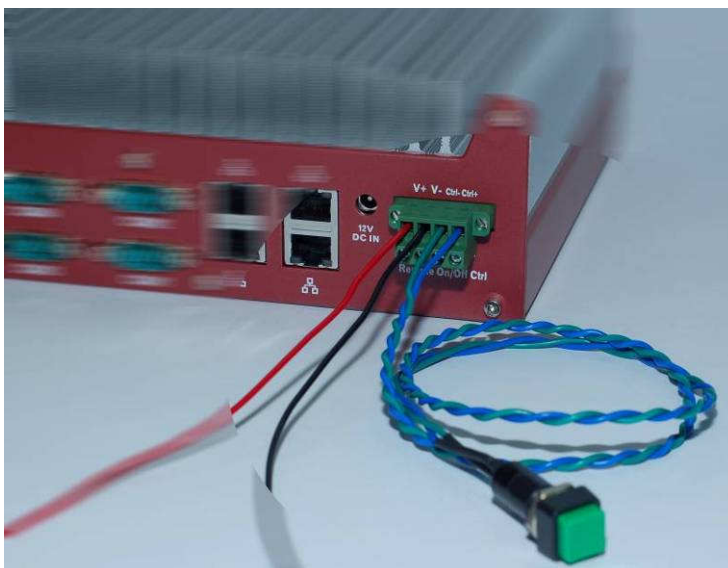

- When the latched switch is closed, the DC power is break off and system is turn off. When the latched switch is open, the DC power is feed-in, and, with the correct setting of **"Power On after Power Failure"** BIOS option, the system is turn on.

To power on Nuvo-1000 using Wake-on-LAN function

Wake-on-LAN (WOL) is a feature to wake up a computer system from a S3 (standby), S4 (Hibernate) or S5 (system off with standby power) state via issuing Subnet Directed Broadcasts (SDB) or a magic packet. Nuvo-1000 implements the Wake-on-LAN function on the GbE port on the front panel. The rest GbE ports on the rear panel do not support WOL function.

To enable WOL function and power on you Nuvo-1000, please follow the steps listed below.

- When Nuvo-1000 boots up, press F2 to enter BIOS setup utility.
- Enter the **[Power]** BIOS setting menu.
- Configure the **[Wake On LAN]** BIOS option as **[Enabled]**. This setting enables the Wake-on-LAN function for Nuvo-1000. Please refer to section 4.1 for the instruction of configuring this option.
- In Windows system, identify the Intel® 82574L Gigabit Connection on PCI bus 1, device 0, function 0. This is the GbE port on the front panel.

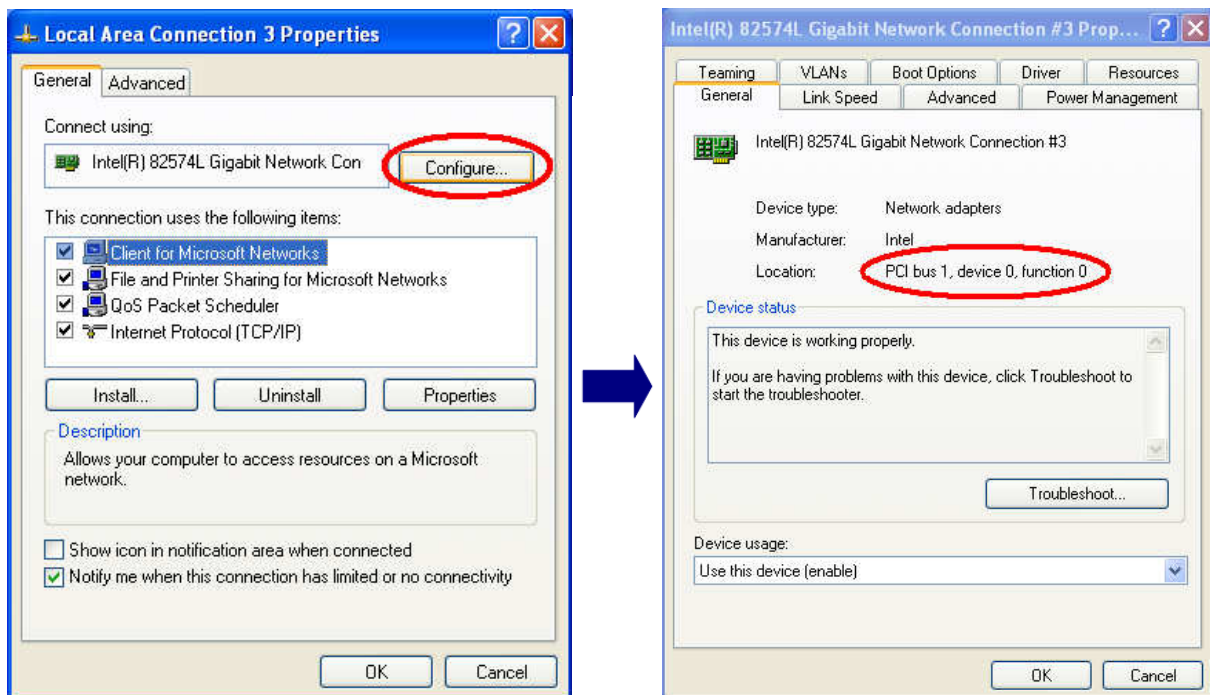

5. Click the Power Management tag, there are several options for Wake-on-LAN.

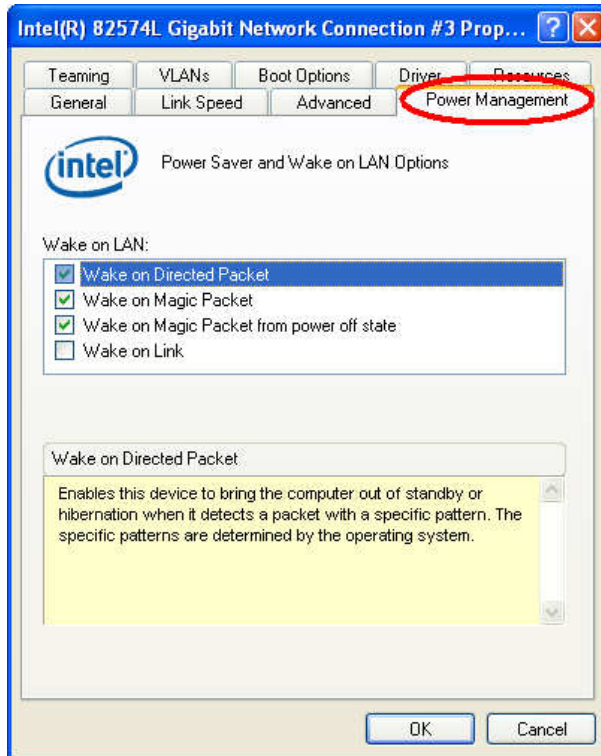

- **Wake on Direct Packet**

Nuvo-1000 can wake from S3 or S4 state when receiving a direct packet, such as a ping command from another computer. Please note that the “Wake on Direct Packet” option does not support waking from S5 state.

- **Wake on Magic Packet**

The Nuvo-1000 can wake from S3 or S4 state when receiving a magic packet. The magic packet is a broadcast frame containing anywhere within its payload 6 bytes of all 255 (FF FF FF FF FF FF in hexadecimal), followed by sixteen repetitions of the target computer's 48-bit MAC address.

For example, NIC's 48-bit MAC Address is 78h D0h 04h 0Ah 0Bh 0Ch

```

DESTINATION SOURCE MISC
FF FF FF FF FF FF
78 D0 04 0A 0B 0C 78 D0 04 0A 0B 0C
78 D0 04 0A 0B 0C 78 D0 04 0A 0B 0C
78 D0 04 0A 0B 0C 78 D0 04 0A 0B 0C
78 D0 04 0A 0B 0C 78 D0 04 0A 0B 0C
78 D0 04 0A 0B 0C 78 D0 04 0A 0B 0C
78 D0 04 0A 0B 0C 78 D0 04 0A 0B 0C
78 D0 04 0A 0B 0C 78 D0 04 0A 0B 0C
78 D0 04 0A 0B 0C 78 D0 04 0A 0B 0C
78 D0 04 0A 0B 0C 78 D0 04 0A 0B 0C
MISC    CRC
    
```



There are some free tools available on Internet that can be used to send a magic packet. Please refer to the following link to understand more about Magic Packet.
<http://en.wikipedia.org/wiki/Wake-on-LAN>

- **Wake on Magic Packet from power off state**

When checking this option, Nuvo-1000 can wake from S5 (system off with standby power) state when receiving a magic packet.

Chapter 4 BIOS and Driver

4.1 BIOS Settings

Nuvo-1000 is shipped with factory-default BIOS settings cautiously programmed for best performance and compatibility. In this section, we'll illustrate some of BIOS settings you may need to modify. Please always make sure you understand the effect of change before you proceed with any modification.

COM1 Operating Mode

COM1 of Nuvo-1000 supports RS-232 (full-duplex), RS-422 (full-duplex) and RS-485 (half-duplex) mode. You can set the COM1 operating mode via BIOS settings. Another option in BIOS called "Slew Rate" defines how sharp the rasing/falling edge is for the output signal of COM1. For long-distance RS-422/485 transmission, you may set the "Slew Rate" option as "High" to improve signal quality

To set COM1 operating mode:

1. When Nuvo-1000 boots up, press F2 to enter BIOS setup utility.
2. Go to **[Advanced]** → **[Peripheral Configuration]**.
3. Set the **[Set COM1 as]** to a proper mode for COM1 of your Nuvo-1000.

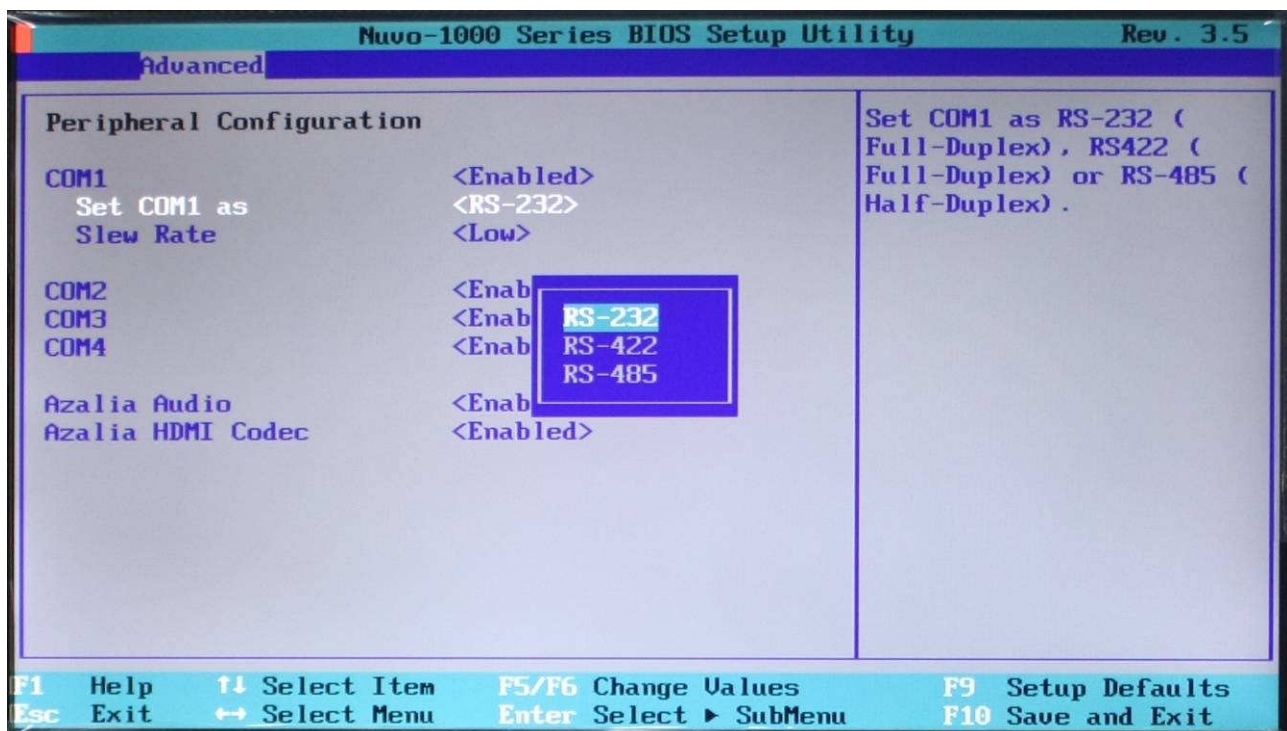

SATA Controller Mode

The SATA controller of Nuvo-1000 supports IDE and AHCI mode. IDE mode is a legacy interface and is compatible with most storage devices. AHCI mode, which exposes SATA's advanced capabilities such as hot swapping and native command queuing, are supported in several later version of operating systems.

Our suggestion of how to set SATA controller mode is

- If you're using Windows XP, Linux kernel earlier than 2.6.19, or you want to use a CF card, you should select IDE mode.
- If you're using Windows Vista, Windows 7, or Linux kernel from 2.6.19 onward, you should select AHCI mode for better performance.

To set SATA controller mode:

1. When Nuvo-1000 boots up, press F2 to enter BIOS setup utility.
2. Go to **[Advanced]** → **[SATA Configuration]**.
3. Set the **[HDC Configure as]** to a proper mode for your Nuvo-1000.

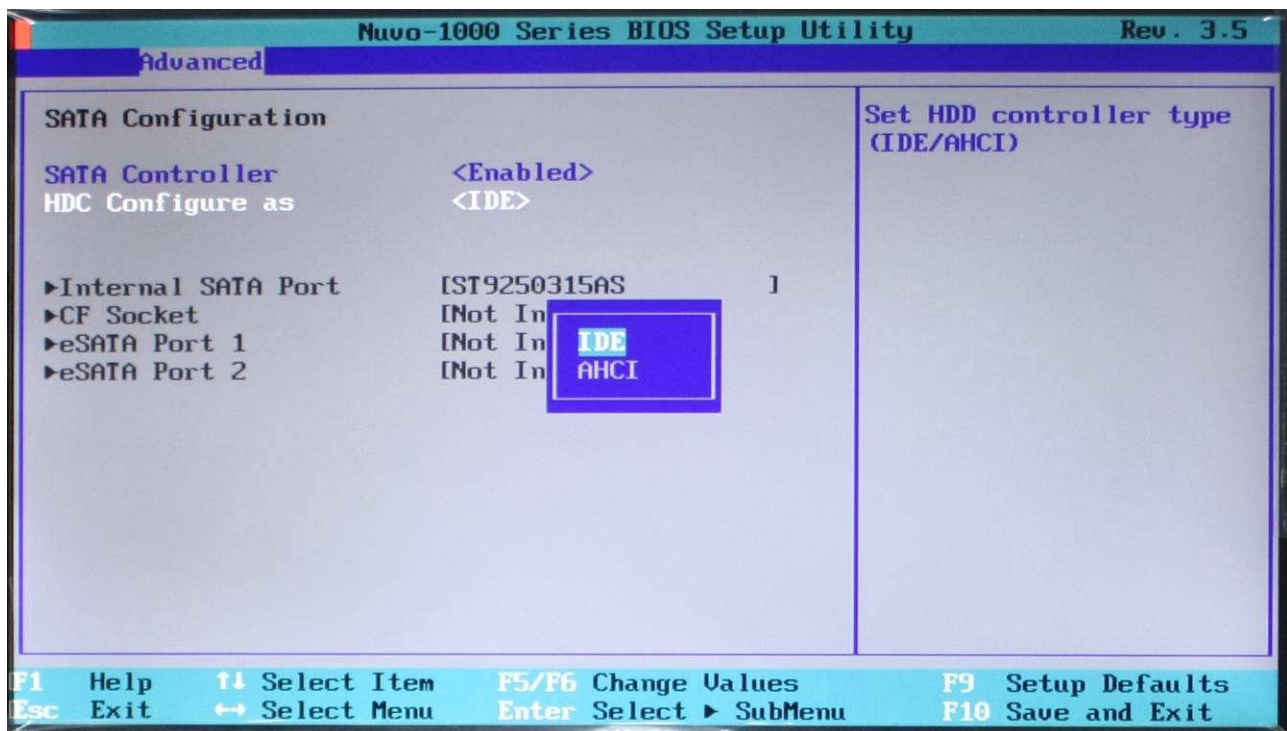

CPU Shutdown Temperature and Thermal Throttling

To avoid CPU from overheating in some circumstances, Intel® provides several measures to protect CPU. When CPU core temperature reaches the throttling-on temperature, CPU start to insert idle clock cycle to reduce heat generated. As if the core temperature is still raising and shutdown temperature is reached, CPU shuts down itself to prevent further damage.

Since Intel® i7/i5 processor has a $T_{j_{max}}$ (core temperature limite) of 105°C and Intel® i3/P4500 processor has a $T_{j_{max}}$ (core temperature limite) of 90°C, we suggest you set these two value according to the following principles:

- For Intel® i7/i5 processor, you should set the shutdown temperature as 105°C and throttling-on temperature as 90°C.
- For Intel® i3/P4500 processor, you should set the shutdown temperature as 90°C and throttling-on temperature as 75°C.

To set CPU shutdown and thermal throttling temperature:

1. When Nuvo-1000 boots up, press F2 to enter BIOS setup utility.
2. Go to **[Advanced]** → **[Thermal Configuration]** → **[Platform Thermal Configuration]**.
3. Set the **[Shut Down Temperature]** to a proper value according to the processor you're using.
4. Set the **[Throttle On Temperature]** to a proper value according to the processor you're using.

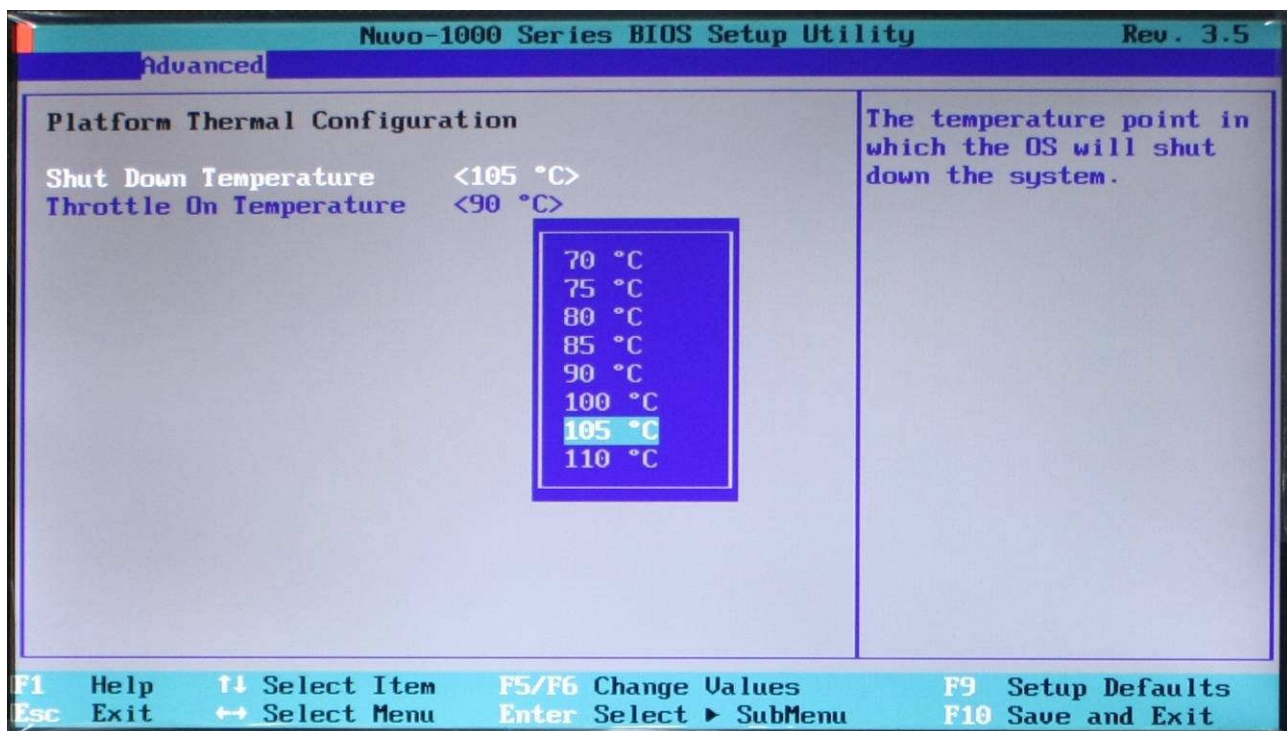

Power On after Power Failure Option

This option defines the behavior of Nuvo-1000 when DC power is supplied.

S0 – Power On	System is powered on when DC power is supplied.
S5 – Power Off	System is kept in off state when DC power is supplied.
Last State	The on/off state of the system is determined according to the last state when DC power is disconnected. For example, if system is still on but DC power is unplugged, the system is powered on next time when DC power is supplied.

When you want to use the remote on/off control function, you have to set this option to “S0 – Power On”. Please refer to section 3.4 for instructions of using remote on/off control function.

To set “Power On after Power Failure” option:

1. When Nuvo-1000 boots up, press F2 to enter BIOS setup utility.
2. Go to **[Advanced]** → **[Chipset Configuration]**.
3. Set the **[Power On after Power Failure]** to a proper value for your Nuvo-1000.

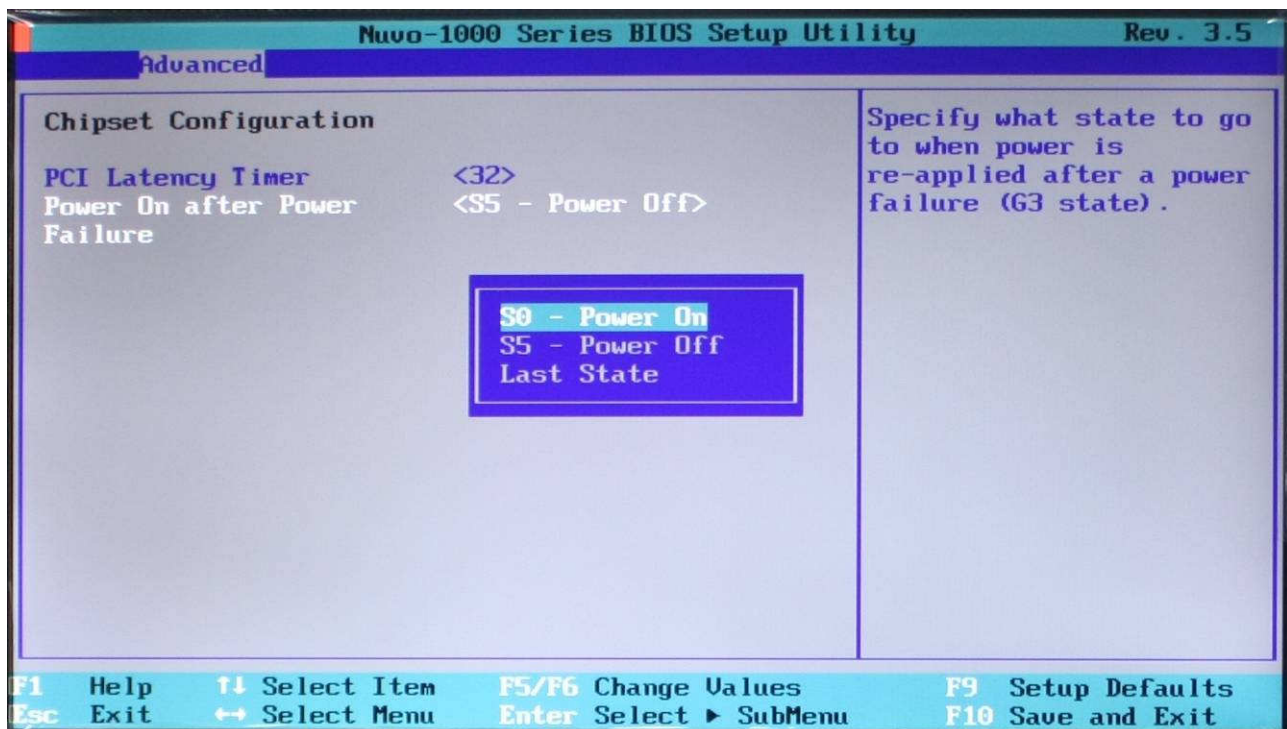

Wake-on-LAN Option

Wake-on-LAN (WOL) is a mechanism which allows you to turn on your Nuvo-1000 via Ethernet connection. To utilize Wake-on-LAN function, you have to enable this option first in BIOS settings. Please refer to section 3.4 for instructions of using WOL function.

To enable/disable "Wake on LAN" option:

1. When Nuvo-1000 boots up, press F2 to enter BIOS setup utility.
2. Go to **[Power]**.
3. Enable/disable the **[Wake on LAN]** option according to your application.

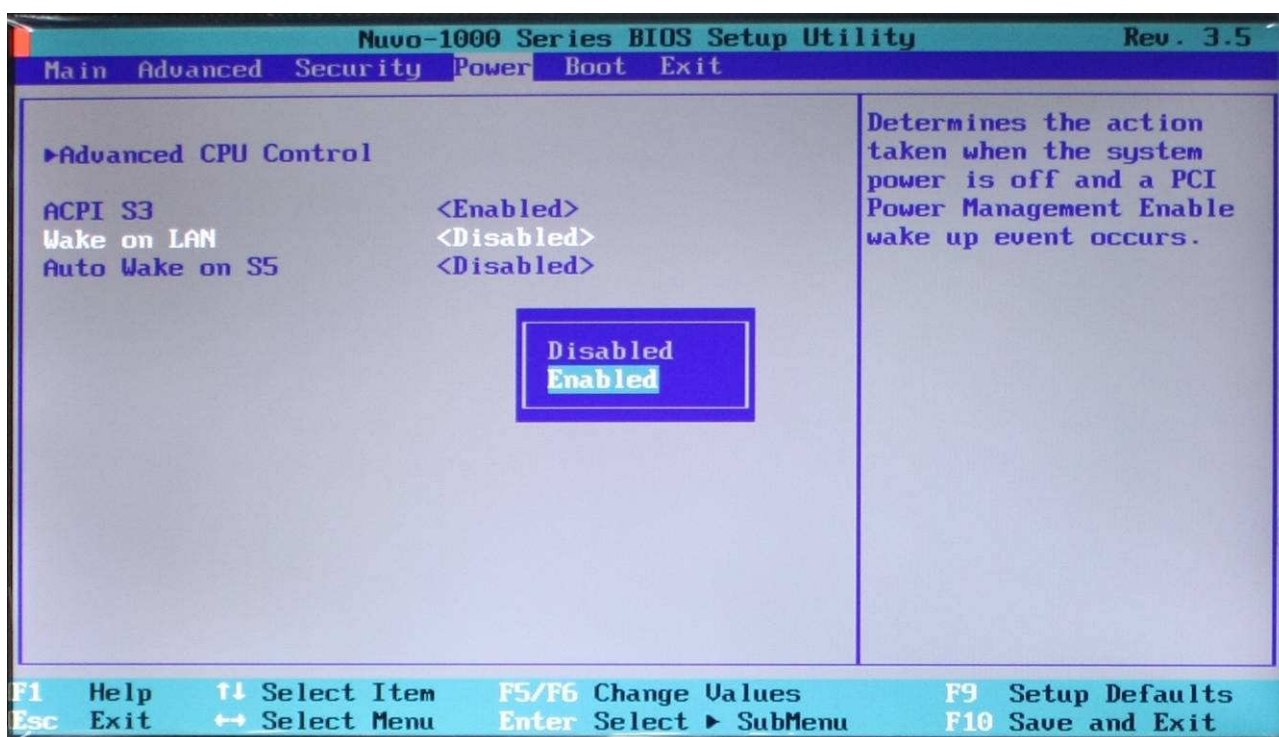

Select a Boot Device

When you have multiple bootable devices connected to your Nuvo-1000 (i.e. HDD, USB flash disk, USB DVD-drive), you may need to select one of them as the boot device. There are two ways to select the device. You can either, press F12 when system boots up to go to Boot Manager and then select one of the devices, or select the boot device in BIOS settings.

To select a boot device in BIOS:

1. When Nuvo-1000 boots up, press F2 to enter BIOS setup utility.
2. Go to **[Boot]** → **[Select Boot Device]**.
3. It appears a list which contains all bootable devices connected to your Nuvo-1000. You can use F5/F6 or +/- to change the boot order.

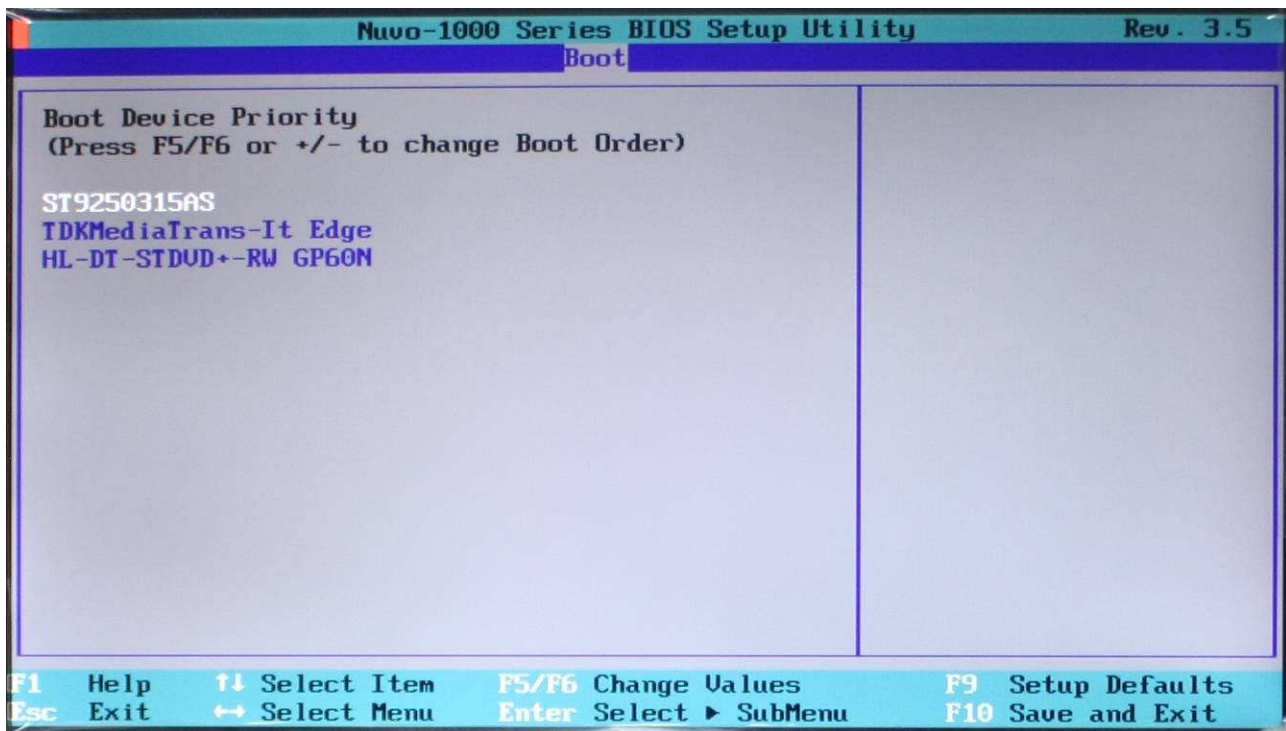

4.2 Operating System Support

Nuvo-1000 supports most operating system developed for Intel® x86 architecture. The following list contains the operating systems which have been tested in Neosys Technology Inc.

- Microsoft Window XP 32-bit
- Microsoft Window 7 32-bit
- Microsoft Window 7 64-bit
- Ubuntu 10.10 Desktop 32bit
- Ubuntu 10.10 Desktop 64bit
- Ubuntu 10.04 LTS Desktop 64bit

Neosys will keep this list updated as we continuously test other operating systems with Nuvo-1000. Please contact us for the latest OS support list.



4.3 Driver Installation

Neosys Technology Inc. provides a very convenient utility in “Drivers & Utilities DVD” to allow the “One-Click” driver installation. This utility automatically detects your Windows operating system and installs all necessary drivers to your Nuvo-1000 with just one mouse click.

To install all drivers using “One-Click” driver installation

1. Insert the “Drivers & Utilities DVD” into a USB or eSATA DVD-drive attached to your Nuvo-1000. A setup utility launches and the following dialog appears.



2. Click on the “**Automatic Driver Installation**”. The setup utility will automatically detect your Windows operating system and install all necessary drivers. According to different versions of Windows, the installation process takes about 6~12 minutes. Once driver installation is done, the setup utility reboots your Windows and your system works normally afterward.

To install drivers manually

You can also manually install each driver for Nuvo-1000. Please refer to the following information about installing drivers for different operating system.

Windows XP SP3

Drivers for Windows XP are located in **x:\Drivers\Nuvo-1000\XP**, which x: stands for your DVD drive. The recommended driver installation sequence is

1. Chipset driver (x:\Drivers\Nuvo-1000\XP\Chipset\infirst_autol.exe)
2. .NET Framework 3.5 (x:\Drivers\Nuvo-1000\XP\DotNET\dotnetfx35.exe)
3. Graphics driver (x:\Drivers\Nuvo-1000\XP\Graphics\Setup.exe)
4. Audio driver (x:\Drivers\Nuvo-1000\XP\Audio\Setup.exe)
5. LAN driver (x:\Drivers\Nuvo-1000\XP\LAN\APPS\PROSETDX\Win32\DxSetup.exe)
6. ME driver (x:\Drivers\Nuvo-1000\XP\ME\Setup.exe)

Windows XP SP2

Drivers for Windows XP are located in **x:\Drivers\Nuvo-1000\XP**, which x: stands for your DVD drive. The recommended driver installation sequence is

1. Chipset driver (x:\Drivers\Nuvo-1000\XP\Chipset\infirst_autol.exe)
2. Windows Installer 3.1
(x:\Drivers\Nuvo-1000\XP\DotNET\WindowsInstaller-KB893803-v2-x86.exe)
3. .NET Framework 3.5 (x:\Drivers\Nuvo-1000\XP\DotNET\dotnetfx35.exe)
4. Audio patch for HD audio
(x:\Drivers\Nuvo-1000\XP\Audio\MSHDQFE\Win2K_XP\us\kb888111xsp2.exe)
5. Graphics driver (x:\Drivers\Nuvo-1000\XP\Graphics\Setup.exe)
6. Audio driver (x:\Drivers\Nuvo-1000\XP\Audio\Setup.exe)
7. LAN driver (x:\Drivers\Nuvo-1000\XP\LAN\APPS\PROSETDX\Win32\DxSetup.exe)
8. ME driver (x:\Drivers\Nuvo-1000\XP\ME\Setup.exe)

Windows 7 or Windows Vista 32-bit

Drivers for Windows 7 or Vista 32-bit are located in **x:\Drivers\Nuvo-1000\Win7_32**, which x: stands for your DVD drive. The recommended driver installation sequence is

1. Chipset driver (x:\Drivers\Nuvo-1000\Win7_32\Chipset\infirst_autol.exe)
2. Graphics driver (x:\Drivers\Nuvo-1000\Win7_32\Graphics\Setup.exe)
3. Audio driver (x:\Drivers\Nuvo-1000\Win7_32\Audio\Setup.exe)
4. LAN driver
(x:\Drivers\Nuvo-1000\Win7_32\LAN\APPS\PROSETDX\Win32\DxSetup.exe)
5. ME driver (x:\Drivers\Nuvo-1000\Win7_32\ME\Setup.exe)



Note

If you are using Windows Vista, you may not have the updated .NET Framework. Please install .NET Framework 3.5 in prior to install Graphics driver. You can find .NET Framework 3.5 in x:\Drivers\Nuvo-1000\XP\DotNET\dotnetfx35.exe.

Windows 7 or Windows Vista 64-bit

Drivers for Windows 7 or Vista 64-bit are located in **x:\Drivers\Nuvo-1000\Win7_64**, which x: stands for your DVD drive. The recommended driver installation sequence is

1. Chipset driver (x:\Drivers\Nuvo-1000\Win7_64\Chipset\infinst_autol.exe)
2. Graphics driver (x:\Drivers\Nuvo-1000\ Win7_64\Graphics\Setup.exe)
3. Audio driver (x:\Drivers\Nuvo-1000\ Win7_64\Audio\Setup.exe)
4. LAN driver
(x:\Drivers\Nuvo-1000\ Win7_64\LAN\APPS\PROSETDX\Winx64\DxSetup.exe)
5. ME driver (x:\Drivers\Nuvo-1000\ Win7_64\ME\Setup.exe)

Note

If you are using Windows Vista, you may not have the updated .NET Framework. Please install .NET Framework 3.5 in prior to install Graphics driver. You can find .NET Framework 3.5 in x:\Drivers\Nuvo-1000\XP\DotNET\dotnetfx35.exe.

Appendix A Using H/W Watchdog Timer

Watchdog timer (WDT) is a hardware mechanism to secure the normal operation of a system. When watchdog timer is set, user's program must periodically reset the timer in prior to watchdog timer is expired. This function allows users to reset the system in case of system or application halts.

On Nuvo-1000, watchdog timer function is implemented using ITE8783 Super I/O chip. We provide an easy-to-use function library to program and utilize the watchdog function. In this chapter, we illustrate how to use the WDT function.

A.1 Before Programming WDT

The WDT_DIO function library is delivered in the form of several individual files. Before you start to program WDT function on Nuvo-1000, you should copy these files to the correct directory.

1. Copy **winio32.dll**, **winio32.sys** and **WDT_DIO32.dll** to C:\Windows\system32\ (if your system drive is not c:, use the exact system drive instead)
2. Copy **WDT_DIO.h** and **WDT_DIO32.lib** to your project workspace.
3. Add **WDT_DIO32.lib** as a linking library of your project.

A.2 Function Reference

InitWDT

Description

Initialize the WDT function. You should always invoke InitWDT() before set or start watch-dog timer.

Parameter

None

Return Value

Always returns TRUE

Usage

BOOL bRet = InitWDT()



SetWDT

Description

Set timeout value and unit for watch-dog timer. When InitWDT() is invoked, a default timeout value of 255 seconds is assigned.

Parameter

tick

WORD value (1 ~ 65535) to indicate timeout ticks.

unit

BYTE value (0 or 1) to indicate unit of timeout ticks.

0 : unit is minute

1: unit is second

Return Value

If value of unit is correct (0 or 1), this function returns TRUE, otherwise FALSE.

Usage

WORD tick=255;

BYTE unit=1; //unit is second.

BOOL bRet = SetWDT(tick, unit); //timeout value is 255 seconds

StartWDT

Description

Start countdown of WDT. When WDT is started, the WDT LED indicator starts to blink in a frequency of 1Hz. If no ResetWDT() or StopWDT is invoked before WDT is counted to 0, the WDT expires and system resets.

Parameter

None

Return Value

If the timeout value is given in correct format, this function returns TRUE, otherwise FALSE.

Usage

BOOL bRet = StartWDT()

ResetWDT

Description

Reset the timeout value to the value given by SetWDT(). If no ResetWDT() or



StopWDT is invoked before WDT is counted to 0, the WDT expires and system resets.

Parameter

None

Return Value

Always returns TRUE;

Usage

BOOL bRet = ResetWDT()

StopWDT

Description

Stop the countdown of WDT. When WDT is stopped, the WDT LED indicator stops blinking.

Parameter

None

Return Value

Always returns TRUE;

Usage

BOOL bRet = StopWDT()

Appendix B Using Isolated DIO

Nuvo-1000 provides the optional isolated digital DIO for industrial control usage. In this chapter, we illustrate how to connect cables to isolated DIO channels and the function reference.

B.1 Wiring for Isolated DIO

The digital input function of Nuvo-1000 is implemented using a photo-coupler with an internally series-connected 4.7k Ω resistor. You need to provide a voltage to specify the logic high/low state. The input voltage for logic high is 5~24V, and the input voltage for logic low is 0~1.5V.

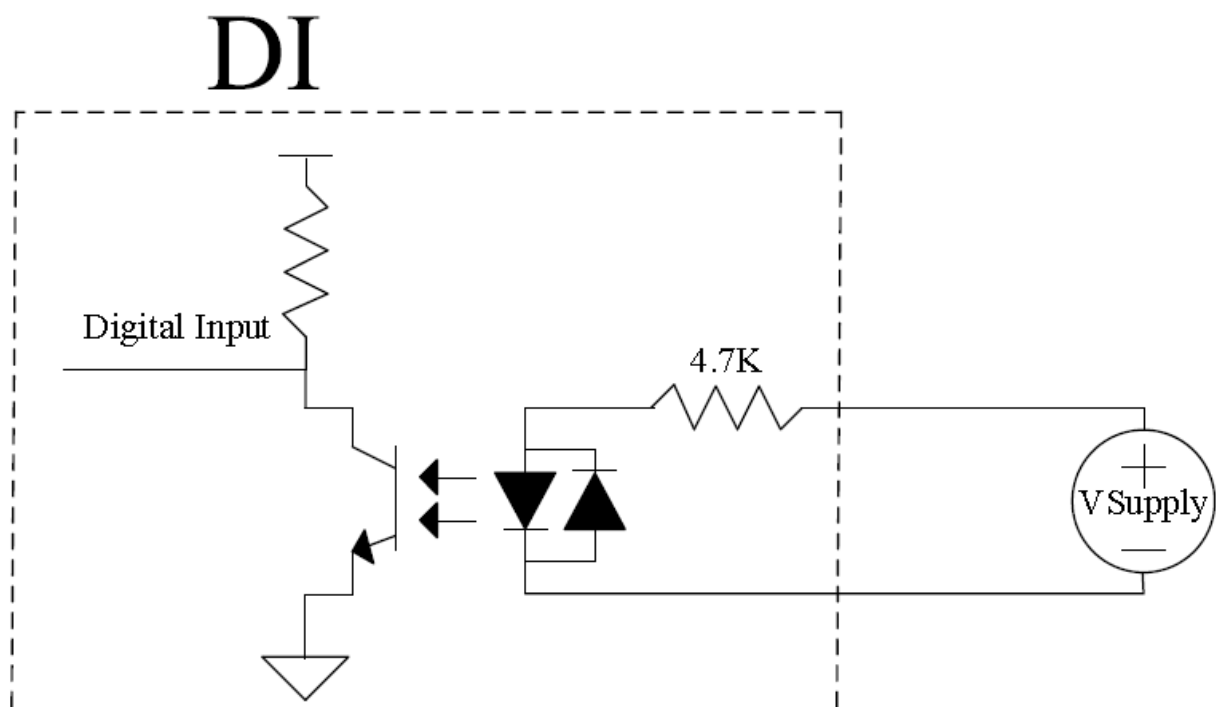

The digital output function of Nuvo-1000 is implemented using Power MOSFET + Analog Device iCoupler[®] component. The DO channels are configured as NO (normally-open) configuration. When you turn on Nuvo-1000, all DO channels have a deterministic state of logic 0 (circuit disconnected from GND return). When logic 1 is specified, MOSFET is activated and GND return path is established. You can use either sinking current connection or sourcing current connection for DO of Nuvo-1000. The following diagrams are the suggested wiring for DO:

DO

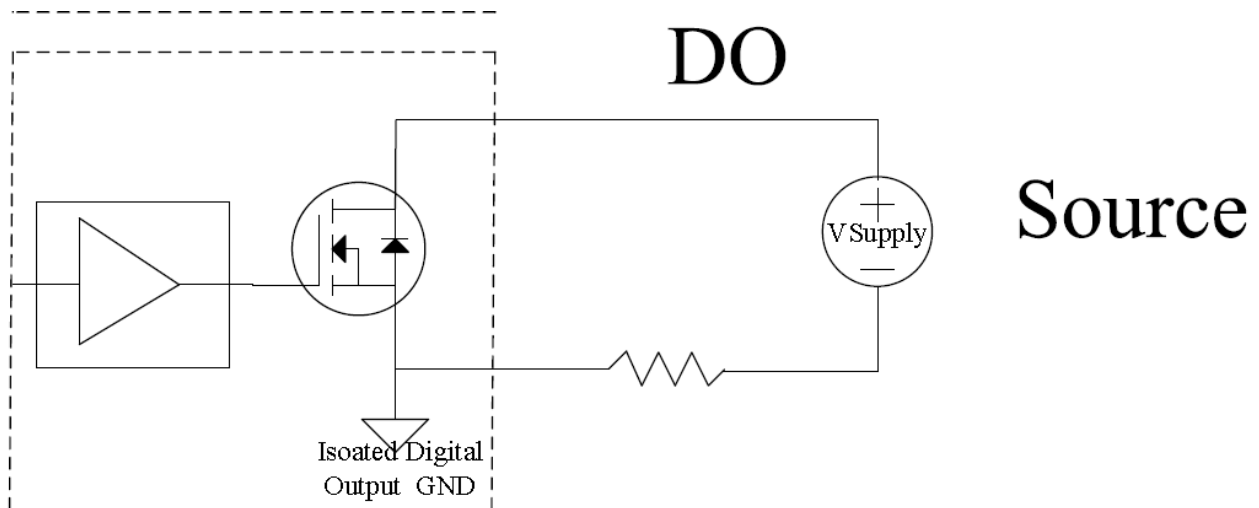
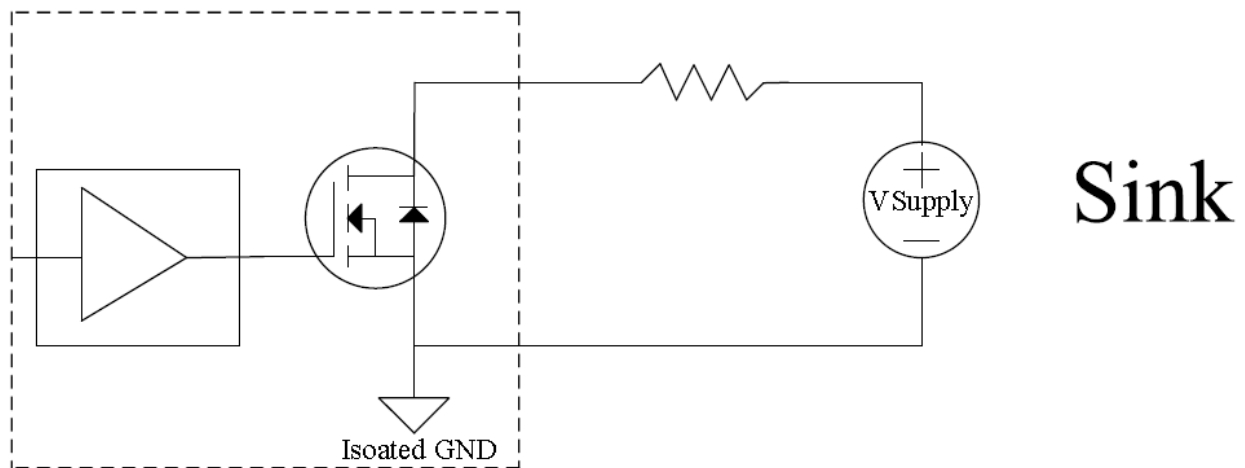

B.2 Before Programming DIO

The WDT_DIO function library is delivered in the form of several individual files. Before you start to program isolated DIO function on Nuvo-1000, you should copy these files to the correct directory.

1. Copy **winio32.dll**, **winio32.sys** and **WDT_DIO32.dll** to C:\Windows\system32\ (if your system drive is not c:, use the exact system drive instead)
2. Copy **WDT_DIO.h** and **WDT_DIO32.lib** to your project workspace.
3. Add **WDT_DIO32.lib** as a linking library of your project.

B.3 Function Reference

InitDIO

Description

Initialize the DIO function. You should always invoke InitDIO() before write/read any DIO port/channel.

Parameter

None

Return Value

Always returns TRUE

Usage

```
BOOL bRet = InitWDT();
```

DIReadLine

Description

Read a single channel of isolated digital input.

Parameter

ch

BYTE value to indicate the DI channel to be read. For Nuvo-1000, *ch* should be a value of 0 ~ 7.

Return Value

The status (TRUE or FALSE) of the specified DI channel.

Usage

```
BYTE ch=3; //DI channel #3
```

```
BOOL DIChValue = DIReadLine(ch); //read DI channel #3
```

DIReadPort

Description

Read the entire isolated digital input port (8 channels).

Parameter

None

Return Value

A WORD value indicates the status of DI port (Lower byte of this WORD value is the



status of 8 DI channels).

Usage

```
WORD DIPortValue = DIRReadPort ();
```

DOWriteLine

Description

Write a single channel of isolated digital output.

Parameter

ch

BYTE value to indicate the DO channel to be written. For Nuvo-1000, *ch* should be a value of 0 ~ 7.

value

BOOL value (TRUE or FALSE) to specify the status of DO channel.

Return Value

None

Usage

```
BYTE ch=3; //DI channel #3
```

```
BOOL DOChValue=TRUE;
```

```
DOWriteLine(ch, DOChValue); //write DO channel #3 as TRUE
```

DOWritePort

Description

Write the entire isolated digital output port (8 channels).

Parameter

value

WORD value to specify the status of the DO port. For Nuvo-1000, *value* should be a value of 0~255.

Return Value

None

Usage

```
WORD DOPortValue=0XFF; //11111111b
```

```
DOWritePort(DOPortValue); //write DO port as 11111111b
```

