



**ADLINK**  
TECHNOLOGY INC.

## **MIX-220**

Embedded Computer System with  
MI-220 Mini-ITX Motherboard

### **User's Manual**



**Manual Rev.:** 2.00  
**Revision Date:** June 4, 2012  
**Part No:** 50-1Z126-1000



Recycled Paper

**Advance Technologies; Automate the World.**

# Revision History

Revision	Release Date	Description of Change(s)
2.00	2012/06/04	Initial release

# Preface

## **Copyright 2012 ADLINK Technology Inc.**

This document contains proprietary information protected by copyright. All rights are reserved. No part of this manual may be reproduced by any mechanical, electronic, or other means in any form without prior written permission of the manufacturer.

## **Disclaimer**

The information in this document is subject to change without prior notice in order to improve reliability, design, and function and does not represent a commitment on the part of the manufacturer.

In no event will the manufacturer be liable for direct, indirect, special, incidental, or consequential damages arising out of the use or inability to use the product or documentation, even if advised of the possibility of such damages.

## **Environmental Responsibility**

ADLINK is committed to fulfill its social responsibility to global environmental preservation through compliance with the European Union's restriction of Hazardous Substances (RoHS) directive and Waste Electrical and Electronic Equipment (WEEE) directive. Environmental protection is a top priority for ADLINK. We have enforced measures to ensure that our products, manufacturing processes, components, and raw materials have as little impact on the environment as possible. When products are at their end of life, our customers are encouraged to dispose of them in accordance with the product disposal and/or recovery programs prescribed by their nation or company.

## **Trademarks**

Product names mentioned herein are used for identification purposes only and may be trademarks and/or registered trademarks of their respective companies.

## Using this Manual

### Audience and Scope

The MIX-220 User's Manual is intended for hardware technicians and systems operators with knowledge of installing, configuring and operating embedded single board computers.

### Manual Organization

This manual is organized as follows:

**Preface:** Presents copyright notifications, disclaimers, trademarks, and associated information on the proper usage of this document and its associated product(s).

**Chapter 1, Introduction:** Introduces the MIX-220, its features, specifications and mechanical dimensions.

**Chapter 2, Getting Started:** Presents information on chassis layout, setup and operation of the MIX-220.

**Chapter 3, Hardware Information:** Provides information about fan removal/replacement, connectors and pin assignments.

**Important Safety Instructions:** Presents safety instructions all users must follow for the proper setup, installation and usage of equipment and/or software.

**Getting Service:** Contact information for ADLINK's worldwide offices.

## Conventions

Take note of the following conventions used throughout this manual to make sure that users perform certain tasks and instructions properly.



NOTE:

Additional information, aids, and tips that help users perform tasks.

---



Information to prevent **minor** physical injury, component damage, data loss, and/or program corruption when trying to complete a task.

---



Information to prevent **serious** physical injury, component damage, data loss, and/or program corruption when trying to complete a specific task.

---

This page intentionally left blank.

# Table of Contents

<b>Revision History</b> .....	<b>ii</b>
<b>Preface</b> .....	<b>iii</b>
<b>List of Figures</b> .....	<b>ix</b>
<b>List of Tables</b> .....	<b>xi</b>
<b>1 Introduction</b> .....	<b>1</b>
1.1 Overview.....	1
1.2 Features.....	2
1.3 Specifications.....	3
1.4 Mechanical Drawing .....	5
<b>2 Getting Started</b> .....	<b>7</b>
2.1 Packing List .....	7
2.2 Chassis Layout .....	8
2.3 Installing the CPU .....	12
2.4 Installing the CPU Cooler .....	14
2.1 Installing the CPU Cooler .....	14
2.5 System Memory.....	15
2.6 SATA Drive Installation.....	16
2.7 Installing PCIe/PCI Cards .....	20
2.8 Wall Mount Brackets.....	21
2.9 Powering Up .....	22
2.10 Driver Installation .....	23
<b>3 Hardware Information</b> .....	<b>25</b>
3.1 Fan Removal and Replacement .....	25
3.2 I/O Connector Pin Definitions .....	28

**Important Safety Instructions..... 33**

**Getting Service ..... 35**



# List of Figures

Figure 1-1: MIX-220 Dimensions (without wall mount brackets).....	5
Figure 1-2: MIX-220 Dimensions (with wall mount brackets).....	6
Figure 2-1: MIX-220 Front/Rear Panel.....	8
Figure 2-2: MIX-220 Drive Bay and Fan Access.....	9

This page intentionally left blank.

# List of Tables

Table 1-1: MIX-220 General Specifications ..... 4

This page intentionally left blank.

# 1 Introduction

This chapter will introduce the MIX-220, its features, specifications, and mechanical layout. For detailed information on the MI-220 Mini-ITX industrial motherboard, refer to the user manual downloadable from the ADLINK website:

[http://www.adlinktech.com/PD/web/PD\\_detail.php?cKind=&pid=1014](http://www.adlinktech.com/PD/web/PD_detail.php?cKind=&pid=1014)

## 1.1 Overview

The MIX-220 is an embedded computer system based on the MI-220 Mini-ITX form factor industrial motherboard supporting 32nm process quad/dual-core Intel® Core™ i7/i5/i3 and Celeron® processors, Intel® QM67 Express chipset and Dual Channel DDR3 1066/1333MHz (up to 8GB) in two SODIMM slots. Features include integrated Intel® HD Graphics (VGA, DVI-D, HDMI outputs), dual Gigabit Ethernet, six USB 2.0 ports, four serial ports (1x RS-232/422/485, 3x RS-232), and an externally accessible anti-shock drive bay for two 2.5" SATA 6Gb/s drives.

The MIX-220 provides a PCIe x16 slot and PCI slot with card holder for add-on cards up to 190mm in length, and a PCI Express Mini Card slot for SSD or Wi-Fi module. Active cooling is provided by dual 6cm fans with air filters that are easily accessible for cleaning or replacement, and wall mount brackets allow for flexible installation.

## 1.2 Features

- ▶ Embedded computer system (330 mm x 212 mm x 88 mm)
- ▶ Supports Intel® Core™ i7/i5/i3 and Celeron® processors, rPGA988B package in Socket G2
- ▶ Integrated Intel® HD Graphics with VGA, DVI-D, HDMI outputs (features dependent on CPU model)
- ▶ 2x GbE (Intel® 82579LM, 82574L controllers)
- ▶ 6x USB 2.0 ports (2x front, 4x rear)
- ▶ Anti-shock drive bay for two 2.5" SATA 6Gb/s drives
- ▶ Four serial ports (1x RS-233/422/485, 3x RS-233)
- ▶ PCIe x16 slot, PCI slot, PCI Express Mini Card slot
- ▶ HD audio with Mic, Line In, Line Out
- ▶ Dual 6cm fans with air filters
- ▶ 250W FlexATX AC power supply
- ▶ Wall mount brackets
- ▶ Mounting point for Wi-Fi antenna
- ▶ RoHS compliant

## 1.3 Specifications

<b>System</b>	
<b>CPU</b>	<ul style="list-style-type: none"> <li>• Intel® Core™ i7-2710QE, 2.1GHz, 6M L2 Cache, 32nm, 45W TDP</li> <li>• Intel® Core™ i5-2510E, 2.5GHz, 3M L2 Cache, 32nm, 35W TDP</li> <li>• Intel® Core™ i3-2330E, 2.2GHz, 3M L2 Cache, 32nm, 35W TDP</li> <li>• Intel® Celeron® B810, 1.6GHz, 2M L2 Cache, 32nm, 35W TDP</li> </ul>
<b>Chipset</b>	<ul style="list-style-type: none"> <li>• Intel® QM67 Express Chipset</li> </ul>
<b>Memory</b>	<ul style="list-style-type: none"> <li>• Dual-Channel DDR3 1066/1333MHz, 2x 204-pin SO-DIMM sockets, up to 8GB</li> </ul>
<b>BIOS</b>	<ul style="list-style-type: none"> <li>• AMI BIOS with 32 Mb SPI flash memory</li> </ul>
<b>Graphics</b>	<ul style="list-style-type: none"> <li>• Integrated Intel® HD Graphics (features dependent on CPU model)</li> </ul>
<b>Ethernet</b>	<ul style="list-style-type: none"> <li>• 2x GbE (Intel® 82579LM, 82574L controllers)</li> <li>• Wake on LAN supported</li> </ul>
<b>Audio</b>	<ul style="list-style-type: none"> <li>• Realtek ALC892 HD audio</li> </ul>
<b>Watchdog Timer</b>	<ul style="list-style-type: none"> <li>• 1-255 second/minute programmable</li> </ul>
<b>Hardware Monitor</b>	<ul style="list-style-type: none"> <li>• CPU temperature and supply voltages</li> </ul>
<b>Operating System</b>	<ul style="list-style-type: none"> <li>• Windows XP/7 32/64-bit, Fedora 14, Red Hat Enterprise Linux 5</li> </ul>
<b>I/O Interfaces</b>	
<b>Front I/O</b>	<ul style="list-style-type: none"> <li>• 2x USB 2.0 ports</li> </ul>
<b>Rear I/O</b>	<ul style="list-style-type: none"> <li>• 2x RJ-45 LAN ports</li> <li>• 4x USB 2.0 ports</li> <li>• 1x DB-15 VGA connector</li> <li>• 1x DVI-I connector (DVI-D signals only)</li> <li>• 1x HDMI type A connector,</li> <li>• 4x serial port connectors</li> <li>• 3.5mm jacks for line-in, line-out and mic-in</li> <li>• 1x PCI expansion slot</li> <li>• 1x PCIe expansion slot</li> </ul>
<b>LEDs/Switches</b>	<ul style="list-style-type: none"> <li>• Power, HDD (drive activity)</li> <li>• On/Off button</li> <li>• Reset button (recessed)</li> </ul>

<b>Power Requirements</b>	
<b>Input</b>	<ul style="list-style-type: none"><li>• 100-240 VAC universal</li></ul>
<b>Mode</b>	<ul style="list-style-type: none"><li>• ATX power</li></ul>
<b>Mechanical and Environment</b>	
<b>Dimensions</b>	<ul style="list-style-type: none"><li>• 330 mm x 212 mm x 88 mm (W x D x H)</li></ul>
<b>Operating Temp.</b>	<ul style="list-style-type: none"><li>• 0°C to 50°C</li></ul>
<b>Storage Temp.</b>	<ul style="list-style-type: none"><li>• -20°C to 75°C</li></ul>
<b>Rel. Humidity</b>	<ul style="list-style-type: none"><li>• 10% to 90%, non-condensing</li></ul>
<b>Certifications</b>	<ul style="list-style-type: none"><li>• CE, FCC Class A</li></ul>

**Table 1-1: MIX-220 General Specifications**



## 1.4 Mechanical Drawing

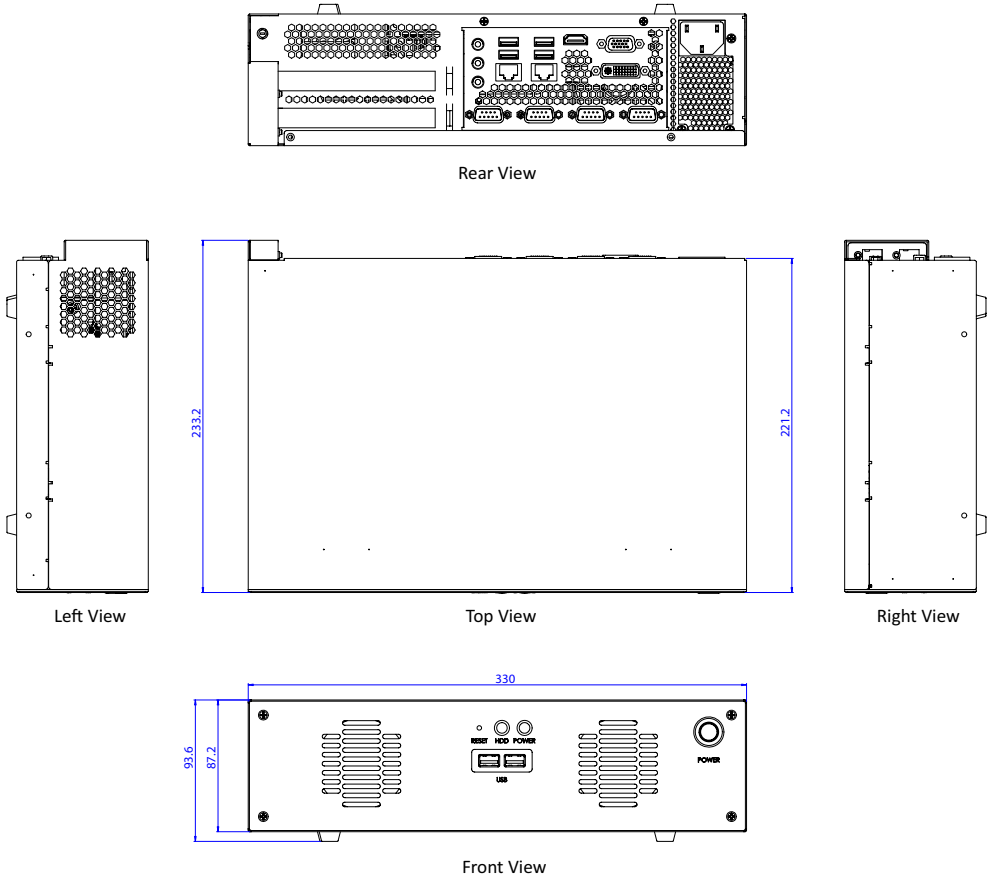

Dimensions in mm

Figure 1-1: MIX-220 Dimensions (without wall mount brackets)

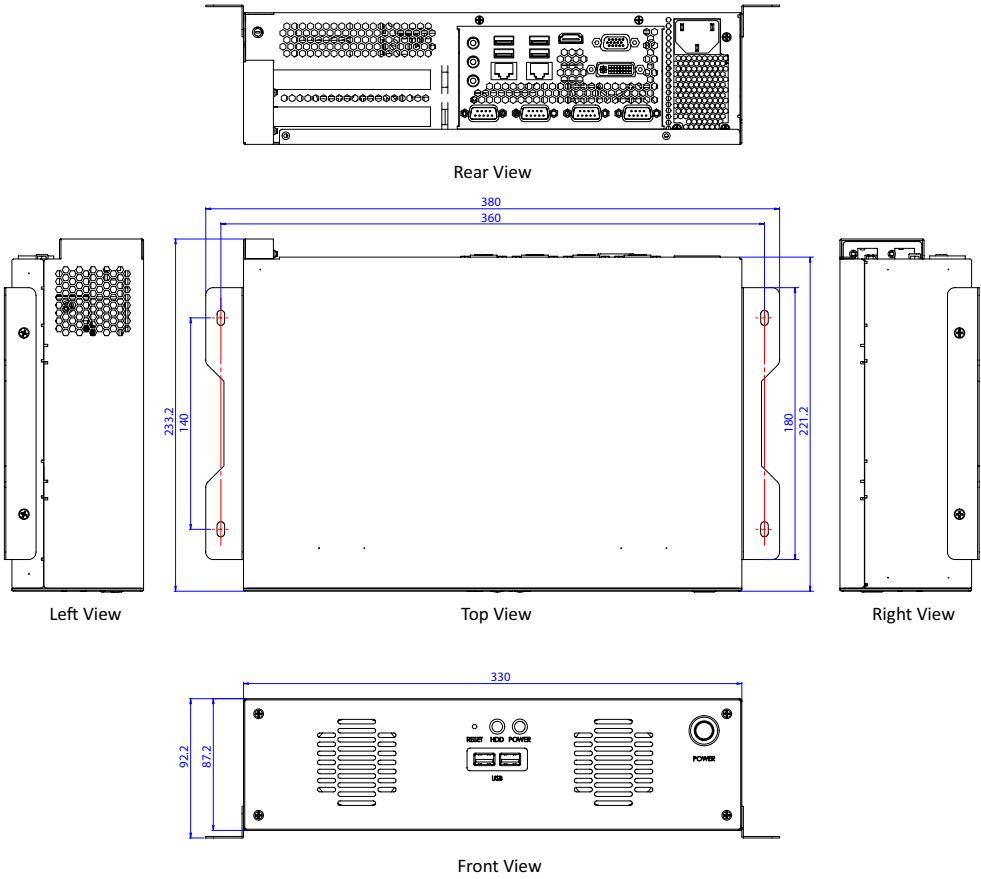

Dimensions in mm

**Figure 1-2: MIX-220 Dimensions (with wall mount brackets)**

## 2 Getting Started

The following chapter describes how to set up the MIX-220.

### 2.1 Packing List

Unpack the contents of the shipping carton. Please check that your package contains the items below. If you discover damaged or missing items, please contact your vendor.

- ▷ MIX-220 Embedded Computer System
- ▷ Accessory kit: drive bay mounting hardware, wall mount brackets, AC power cord (US)
- ▷ Driver CD
- ▷ MI-220 Motherboard Quick Reference Guide



**DO NOT** install or apply power to equipment that is damaged or if there is missing/incomplete equipment. Retain the shipping carton and packing materials for inspection. Please contact your ADLINK dealer/vendor immediately for assistance. Obtain authorization from your dealer before returning any product to ADLINK.



To prevent damage to the system, ensure there is sufficient clearance around the air vents for unrestricted airflow. The air temperature inside the enclosure could rise above the specified operating temperature limits if the airflow through the vents is restricted.

---

## 2.2 Chassis Layout

### Front and Rear Panels

Connect the desired peripheral devices (e.g. monitor, keyboard, mouse, LAN) to the system. Refer to Figure 2-1 below for connector locations.

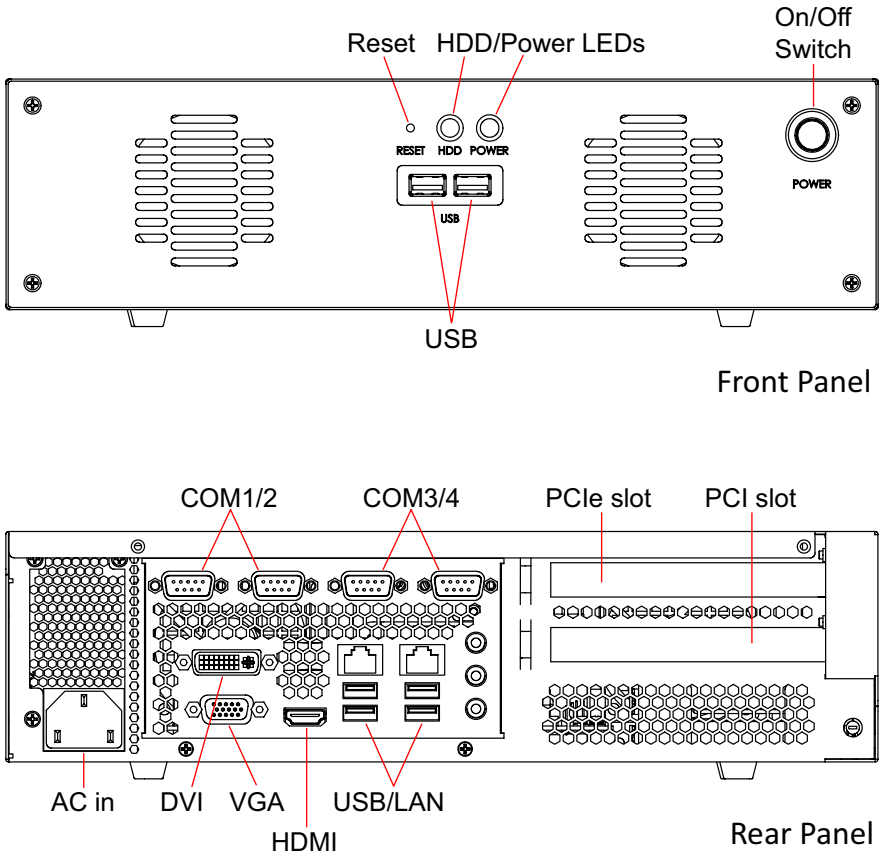

**Figure 2-1: MIX-220 Front/Rear Panel**

## Drive Bay and Fan Access

The drive bay and cooling fan modules can be accessed from the bottom of the chassis as shown below. See “SATA Drive Installation” on page 16 and “Fan Removal and Replacement” on page 25 for more information.

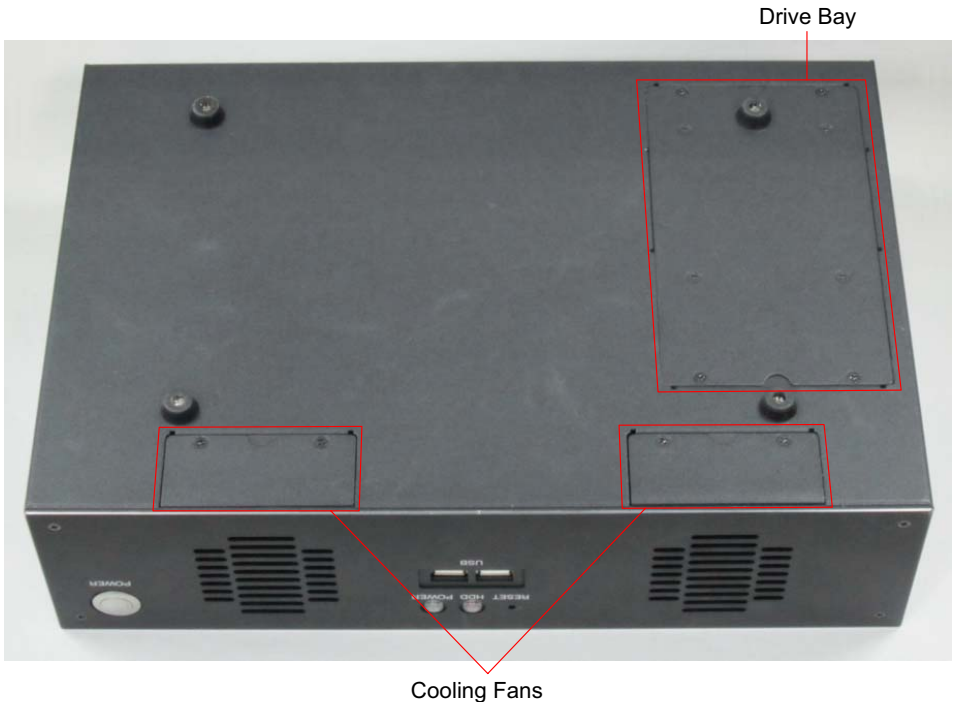

Figure 2-2: MIX-220 Drive Bay and Fan Access

## Removing the Chassis Cover

1. Remove the two screws indicated below.



2. Slide the cover back to release the front edge.

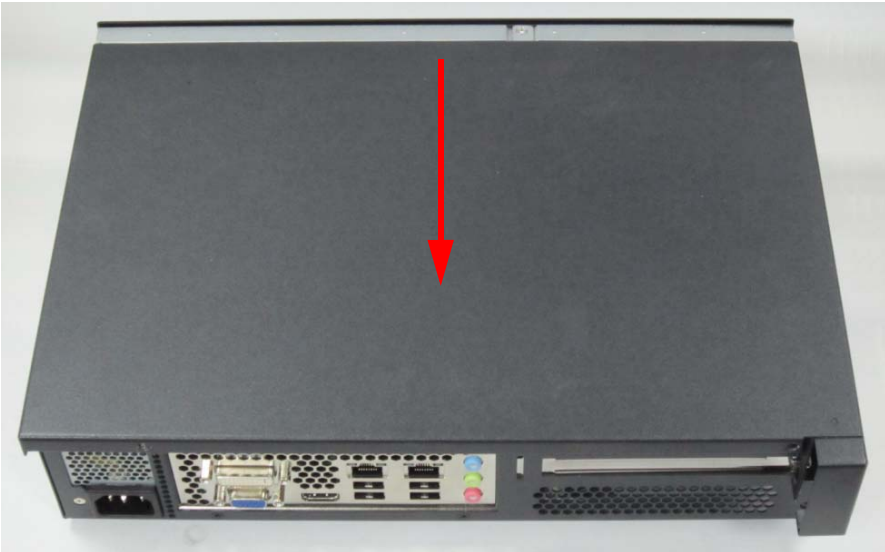

3. Lift off the cover to access the inside of the chassis.



## 2.3 Installing the CPU

The MI-220 motherboard supports rPGA988B package Intel® Core™ and Celeron® processors in Socket G2.



When installing, carefully hold the CPU by its edges and do not force the CPU into the socket to avoid bending the pins.

To install the CPU:

1. Locate the CPU socket. If the socket is locked, use a flathead screwdriver to turn the CPU lock screw counter-clockwise to the unlocked position.

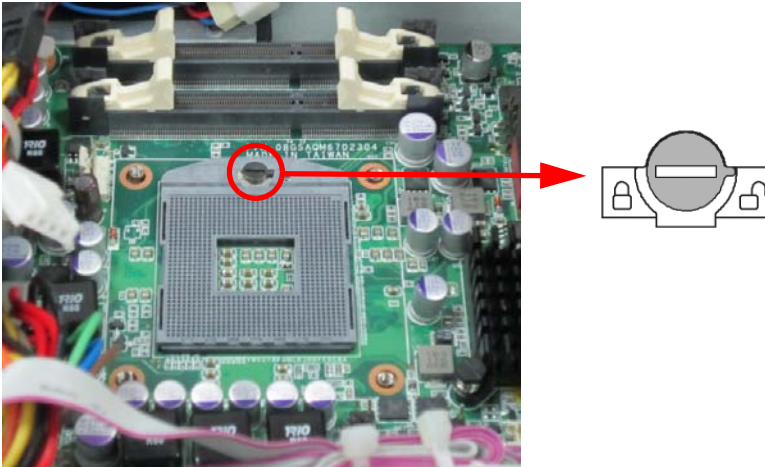



- Align the gold triangle at the upper-right corner of the CPU with the triangular mark at the upper-right corner of the socket. Gently place the CPU into the socket. It should drop into the socket without having to apply any downward force.



You should not have to press down on the processor. If the processor does not drop completely into the socket, make sure the CPU lock screw is fully turned to the unlocked position.

- While gently holding the processor down with your finger, turn the CPU lock screw clockwise to lock the CPU in place.



## 2.4 Installing the CPU Cooler



An approved CPU cooler must be installed before using the system. Failure to install a CPU cooler may damage the motherboard and/or CPU.

To install the CPU cooler:

1. The CPU cooler has a layer of thermal grease pre-applied. If you are reinstalling the CPU, apply a new layer of thermal grease evenly to the top of the installed CPU.
2. Position the heatsink on top of the installed CPU until the heatsink screws match the screw holes on the board.
3. Tighten the heatsink's spring-loaded screws in a diagonal sequence until it is securely attached to the board.
4. Connect the fan power cable to the CPU fan connector on the motherboard (CPU\_FAN1)

**CPU Fan Connector**

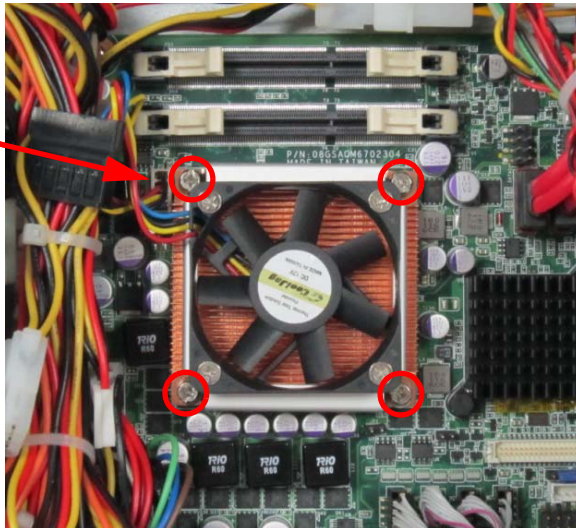

## 2.5 System Memory

The MI-220 supports up to 8GB of DDR3 1066/1333MHz in two 204-pin SO-DIMM sockets.

### Memory Module Installation

The DDR3 memory modules are notched to facilitate correct installation in the DIMM sockets.



Disconnect all power supply to the board before installing a memory module to prevent damaging the board and memory module.

To install a memory module:

1. Locate the SO-DIMM slots on the motherboard.
2. Align the memory module on the socket, making sure that the notch matches the break on the socket.
3. Insert the module firmly into the slot until the retaining clips snap back inwards and the module is securely seated.

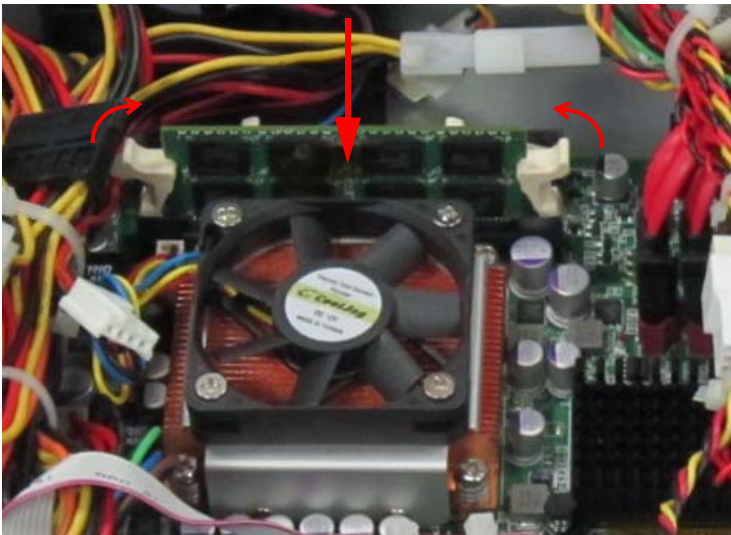

## 2.6 SATA Drive Installation

1. Remove the four screws securing the drive bracket to the chassis.

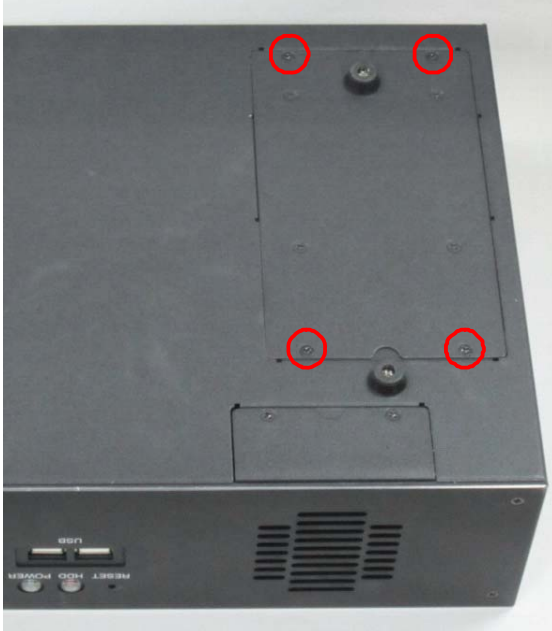

2. Lift the drive bracket out of the chassis.

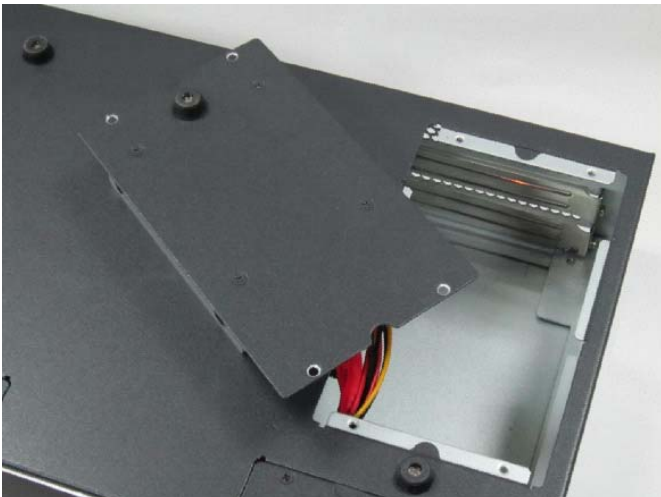

3. Remove the four screws securing the two sets of SATA signal and power cables to the drive bracket.

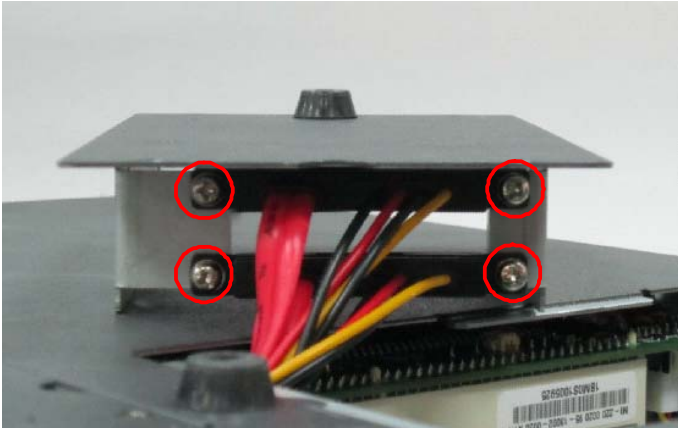

4. Turn the drive bracket over and locate the mounting screws and shock absorbers in the accessory kit (four each per drive).



5. Carefully insert four shock absorbers for each drive you wish to install.



6. Place the 2.5" SATA drive in the drive bracket with the top side up as shown. Check that the connectors on the drive align with the opening in the bracket. Secure the drive to the bracket with the mounting screws provided.



**SATA  
Connectors**

7. Repeat steps 5 and 6 if you wish to install a second drive.

8. Connect the SATA signal and power cable(s) to the drive(s) and secure both cables to the bracket with the four screws removed in step 3.

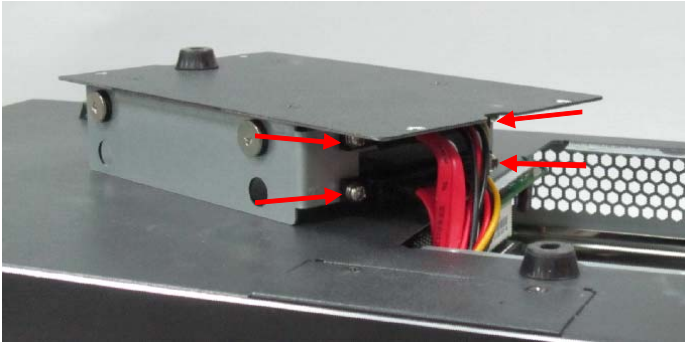

CAUTION:

Be sure to secure both sets of SATA cables to the drive bracket to prevent them from interfering with cooling fan operation. Failure to do so may cause the system to over-heat and/or damage components.

9. Place the drive bracket into the chassis and secure it with the four screws removed in step 1.



## 2.7 Installing PCIe/PCI Cards

Remove the chassis cover as described on page 10. The MIX-220 provides one PCIe x16 expansion slot (upper) and one PCI expansion slot (lower). The maximum allowed card length is 190 mm.

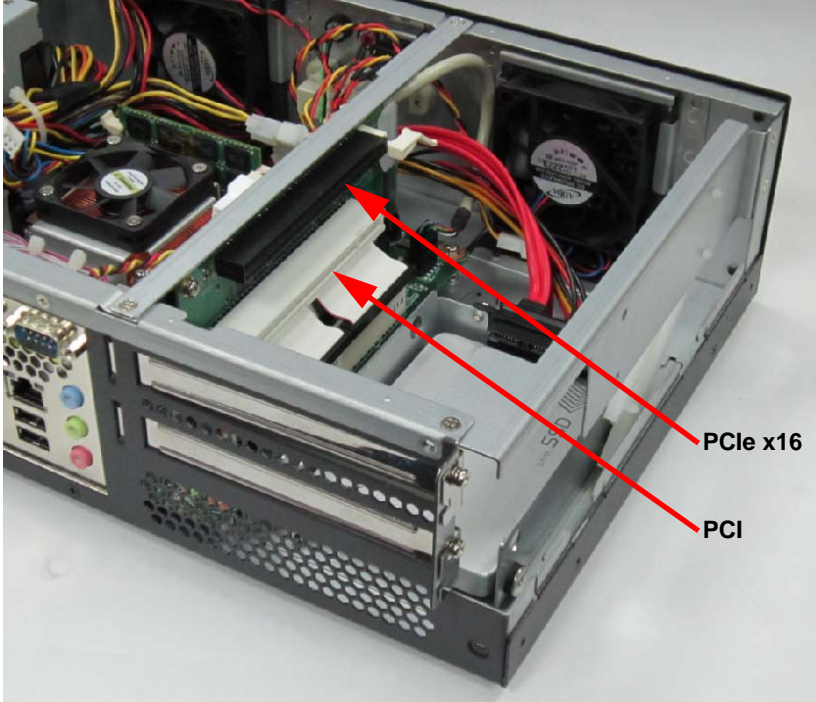



## 2.8 Wall Mount Brackets

Two wall mount brackets and mounting screws are provided for the MIX-220. Before installing the brackets, remove the four rubber feet from the bottom of the chassis as indicated below.



The bracket mounting locations are shown in Figure 1-2: MIX-220 Dimensions (with wall mount brackets) on page 6.

## **2.9 Powering Up**

Connect the AC power cord to the AC connector on the rear panel of the chassis. Plug the AC power cord into a suitable wall outlet. Power on any peripheral devices, such as a display monitor.

Press the On/Off power switch on the front of the chassis to power on the system.

## 2.10 Driver Installation

The MI-220 drivers for **Windows XP 32-bit** are located in the following directories on the Driver CD, or can be downloaded from the ADLINK website (<http://www.adlinktech.com>):

<b>Chipset</b>	X:\Driver\Step 1_CHIP\
<b>Display</b>	X:\Driver\Step 2_VGA\winxp32
<b>LAN</b>	X:\Driver\Step 3_LAN\XP_32
<b>Audio</b>	X:\Driver\Step 4_AUDIO\XP 32_64
<b>RAID</b>	X:\Driver\Step 5_RAID\
<b>Mgmt. Engine</b>	X:\Driver\Step 6_ME\

Follow the instructions below to install the required MI-220 drivers:

1. Install the Windows operating system before installing any driver. Most standard I/O device drivers are installed during Windows installation.



NOTE:

In order to enable AHCI mode, you must pre-install the Intel® Rapid Storage Technology driver using the F6 installation method described in **X:\Driver\Step 5\_RAID\F6Readme.txt**.

2. Install the **Chipset driver** by running the program **X:\Driver\Step 1\_CHIP\infinst\_autol.exe**. Follow the instructions given and reboot when instructed.
3. Install the **Display driver** and utilities by running the program **X:\Driver\Step 2\_VGA\winxp32\winxp\_14464.exe**. Follow the instructions given and reboot when instructed.
4. Install the **LAN driver** by running the program **X:\Driver\Step 3\_LAN\XP\_32PROWin32.exe**. Follow the instructions given and reboot if required.
5. Install the **Audio driver** by running the program **X:\Driver\Step 4\_AUDIO\XP 32\_64\WDM\_R261.exe**. Follow the instructions given and reboot if required.

6. Install the **Intel Rapid Storage Technology Utility** by extracting and running the program **iata\_cd\_10.6.0.1022.exe** in **X:\Driver\Step 5\_RAID\Intel\_Rapid\_Storage\_Technology\_10.6.0.1022.zip**.



NOTE:

The Intel Rapid Storage Technology Utility file may not be included on the Driver CD. Please download it from the ADLINK website if necessary.

---

Install the **Management Engine driver** by running the program **X:\Driver\Step 6\_ME\setup.exe**. Follow the instructions given and reboot if required.

## 3 Hardware Information

### 3.1 Fan Removal and Replacement

1. Remove the two screws securing the fan module to the chassis.



2. Lift the fan module out of the chassis as shown. Cut and remove the cable tie to release the wiring.

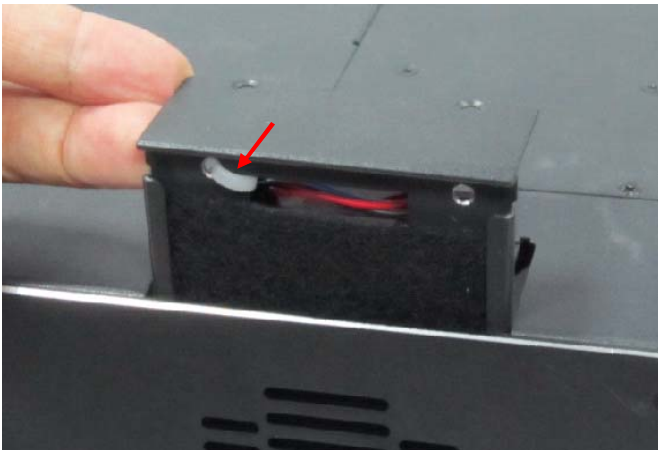

3. Remove the fan module from the chassis. Replace the fan and/or air filter as required.

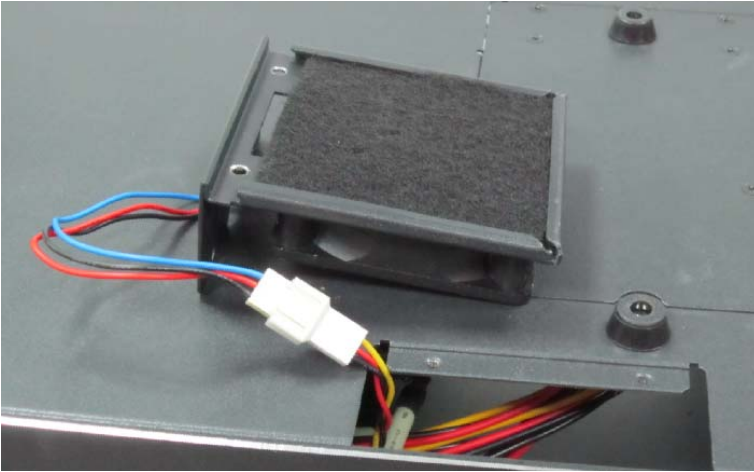

4. Use a new cable tie to shorten the wiring and secure it towards the center of the chassis as shown to prevent the wiring from interfering with normal fan operation.

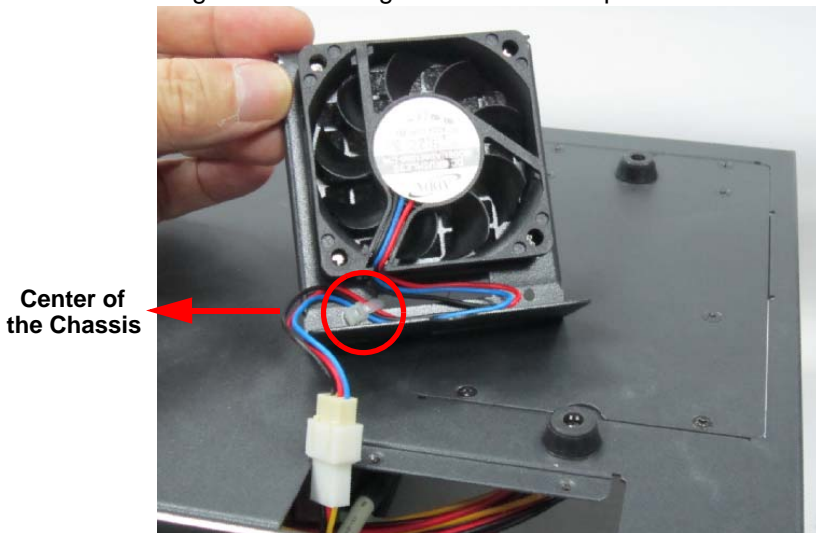

Failure to properly secure the wiring may result in improper cooling fan operation, causing the system to overheat and/or damage to components.

5. Insert the fan module into the chassis. Make sure the module fits into the slots inside the chassis.

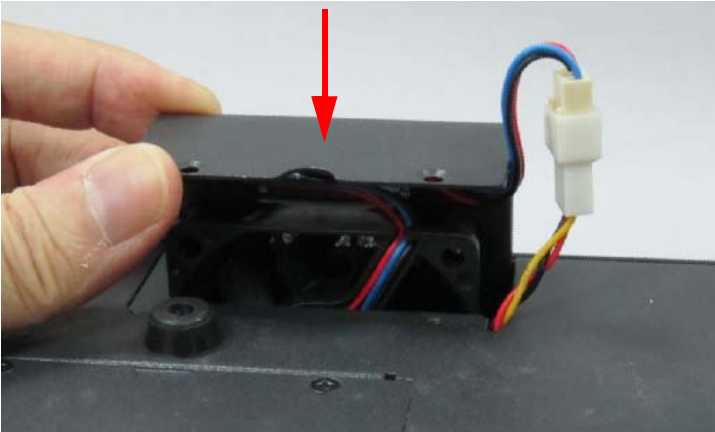

6. Place the connector into the gap beside the fan to allow it to fit into the chassis.

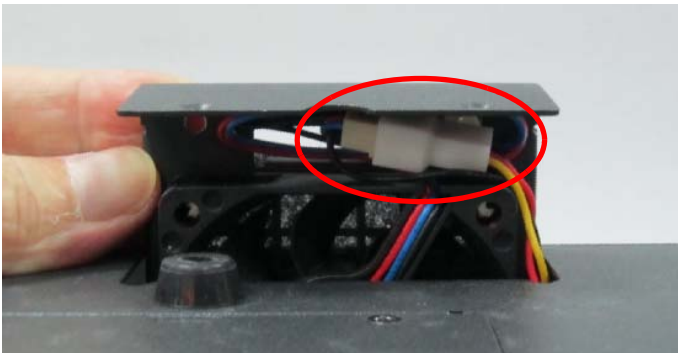

7. Slide the module into the chassis and secure it with the two screws removed in step 1.
8. Repeat steps 1 through 7 for the other fan module if required.

## 3.2 I/O Connector Pin Definitions

For detailed information about onboard motherboard connectors and pin definitions, refer to the MI-220 User's Manual.

### VGA Connector.

Signal Name	Pin #	Pin #	Signal Name
Red	1	2	Green
Blue	3	4	VCC pull-up
GND	5	6	GND
GND	7	8	GND
VCC	9	10	GND
VCC pull-up	11	12	DDC2B DATA
HSYNC	13	14	VSYNC
DDC2B CLK	15		

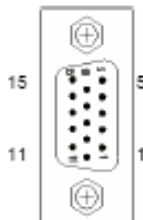

### HDMI Connector

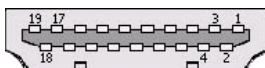

Pin #	Signal	Pin #	Signal
1	TMDS Data2+	2	TMDS Data2 Shield
3	TMDS Data2-	4	TMDS Data1+
5	TMDS Data1 Shield	6	TMDS Data1-
7	TMDS Data0+	8	TMDS Data0 Shield
9	TMDS Data0-	10	TMDS Clock+
11	TMDS Clock Shield	12	TMDS Clock-
13	CEC	14	Reserved
15	SCL	16	SDA
17	DDC/CEC Ground	18	+5 V Power
19	Hot Plug Detect		



## DVI-D Connector

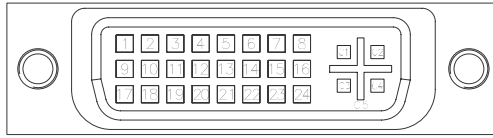

Pin #	Signal	Pin #	Signal
1	TMDS Data2-	16	Hot Plug Detect
2	TMDS Data2+	17	TMDS Data0-
3	TMDS Data2/4 Shield	18	TMDS Data0+
4	TMDS Data4-	19	TMDS Data0/5 Shield
5	TMDS Data4+	20	TMDS Data5-
6	DDC Clock	21	TMDS Data5+
7	DDC Data	22	TMDS Clock Shield
8	Analog Vertical Sync	23	TMDS Clock +
9	TMDS Data1-	24	TMDS Clock -
10	TMDS Data1+	C1	NC
11	TMDS Data1/3 Shield	C2	NC
12	TMDS Data3-	C3	NC
13	TMDS Data3+	C4	NC
14	+5 V Power	C5	NC
15	GND		



NOTE:

Although the connector has a DVI-I type pinout, pins C1 through C5 are not connected and VGA signals are NOT supported.

## USB Connectors

Pin #	Signal Name
1	Vcc
2	USB-
3	USB+
4	GND

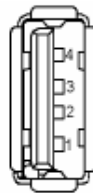

## LAN Port (RJ-45)

This port allows gigabit connection to a Local Area Network (LAN) using a network hub. The LAN port comes with two LEDs to indicate link, activity and speed. Refer to the tables below for the LAN port pin and LED definitions.

Pin #	10BASE-T/100BASE-TX	1000BASE-T
1	TX+	BI_DA+
2	TX-	BI_DA-
3	RX+	BI_DB+
4	--	BI_DC+
5	--	BI_DC-
6	RX-	BI_DB-
7	--	BI_DD+
8	--	BI_DD-

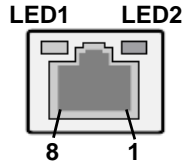

LED1 (Activity/Link)		LED2 (Speed)	
Status	Description	Status	Description
Off	No Link	Off	10 Mb connection
Orange	Linked	Orange	100 Mb connection
Blinking	Data Activity	Green	1 Gb connection

## Audio Ports

The three-jack audio I/O supports Line-In, Line-Out, and Mic-In functions. The blue Line-In jack connects to an audio source such as a CD player. The green Line-Out port connects to speakers or headphones, while the pink Mic-In jack connects to a microphone.

## COM1 Connector (DB-9)

Pin #	RS-232	RS-422	RS-485
1	DCD-L	TXD-	TXD-
2	RXD	TXD+	TXD+
3	TXD	RXD+	—
4	DTR-L	RXD-	—
5	GND	GND	GND
6	DSR-L	—	—
7	RTS-L	—	—
8	CTS-L	—	—
9	RI-L	—	—

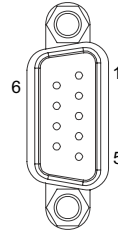

NOTE:

See the MI-220 User's Manual BIOS chapter for COM1 Serial Port Mode settings.

## COM2~4 Connector (DB-9)

Pin #	RS-232
1	DCD-L
2	RXD
3	TXD
4	DTR-L
5	GND
6	DSR-L
7	RTS-L
8	CTS-L
9	RI-L

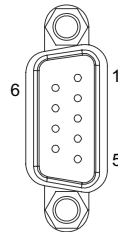

This page intentionally left blank.

# Important Safety Instructions

For user safety, please read and follow all **instructions**, **WARNINGS**, **CAUTIONS**, and **NOTES** marked in this manual and on the associated equipment before handling/operating the equipment.

- ▶ Read these safety instructions carefully.
- ▶ Keep this user's manual for future reference.
- ▶ Read the specifications section of this manual for detailed information on the operating environment of this equipment.
- ▶ When installing/mounting or uninstalling/removing equipment:
  - ▷ Turn off power and unplug any power cords/cables.
- ▶ To avoid electrical shock and/or damage to equipment:
  - ▷ Keep equipment away from water or liquid sources;
  - ▷ Keep equipment away from high heat or high humidity;
  - ▷ Keep equipment properly ventilated (do not block or cover ventilation openings);
  - ▷ Make sure to use recommended voltage and power source settings;
  - ▷ Always install and operate equipment near an easily accessible electrical socket-outlet;
  - ▷ Secure the power cord (do not place any object on/over the power cord);
  - ▷ Only install/attach and operate equipment on stable surfaces and/or recommended mountings; and,
  - ▷ If the equipment will not be used for long periods of time, turn off and unplug the equipment from its power source.

- ▶ Never attempt to fix the equipment. Equipment should only be serviced by qualified personnel.

A Lithium-type battery may be provided for uninterrupted, backup or emergency power.

---



Risk of explosion if battery is replaced with one of an incorrect type. Dispose of used batteries appropriately.

---

- ▶ Equipment must be serviced by authorized technicians when:
  - ▷ The power cord or plug is damaged;
  - ▷ Liquid has penetrated the equipment;
  - ▷ It has been exposed to high humidity/moisture;
  - ▷ It is not functioning or does not function according to the user's manual;
  - ▷ It has been dropped and/or damaged; and/or,
  - ▷ It has an obvious sign of breakage.

# Getting Service

Contact us should you require any service or assistance.

## **ADLINK Technology, Inc.**

Address: 9F, No.166 Jian Yi Road, Zhonghe District  
New Taipei City 235, Taiwan  
新北市中和區建一路 166 號 9 樓  
Tel: +886-2-8226-5877  
Fax: +886-2-8226-5717  
Email: [service@adlinktech.com](mailto:service@adlinktech.com)

## **Ampro ADLINK Technology, Inc.**

Address: 5215 Hellyer Avenue, #110, San Jose, CA 95138, USA  
Tel: +1-408-360-0200  
Toll Free: +1-800-966-5200 (USA only)  
Fax: +1-408-360-0222  
Email: [info@adlinktech.com](mailto:info@adlinktech.com)

## **ADLINK Technology (China) Co., Ltd.**

Address: 上海市浦东新区张江高科技园区芳春路 300 号 (201203)  
300 Fang Chun Rd., Zhangjiang Hi-Tech Park,  
Pudong New Area, Shanghai, 201203 China  
Tel: +86-21-5132-8988  
Fax: +86-21-5132-3588  
Email: [market@adlinktech.com](mailto:market@adlinktech.com)

## **ADLINK Technology Beijing**

Address: 北京市海淀区上地东路 1 号盈创动力大厦 E 座 801 室(100085)  
Rm. 801, Power Creative E, No. 1, B/D  
Shang Di East Rd., Beijing, 100085 China  
Tel: +86-10-5885-8666  
Fax: +86-10-5885-8626  
Email: [market@adlinktech.com](mailto:market@adlinktech.com)

## **ADLINK Technology Shenzhen**

Address: 深圳市南山区科技园南区高新南七道 数字技术园  
A1 栋 2 楼 C 区 (518057)  
2F, C Block, Bldg. A1, Cyber-Tech Zone, Gao Xin Ave. Sec. 7,  
High-Tech Industrial Park S., Shenzhen, 518054 China  
Tel: +86-755-2643-4858  
Fax: +86-755-2664-6353  
Email: [market@adlinktech.com](mailto:market@adlinktech.com)

## **LIPPERT ADLINK Technology GmbH**

Address: Hans-Thoma-Strasse 11, D-68163, Mannheim, Germany  
Tel: +49-621-43214-0  
Fax: +49-621 43214-30  
Email: [emea@adlinktech.com](mailto:emea@adlinktech.com)

**ADLINK Technology, Inc. (French Liaison Office)**

Address: 15 rue Emile Baudot, 91300 Massy CEDEX, France  
Tel: +33 (0) 1 60 12 35 66  
Fax: +33 (0) 1 60 12 35 66  
Email: france@adlinktech.com

**ADLINK Technology Japan Corporation**

Address: 〒101-0045 東京都千代田区神田鍛冶町 3-7-4  
神田 374 ビル 4F  
KANDA374 Bldg. 4F, 3-7-4 Kanda Kajicho,  
Chiyoda-ku, Tokyo 101-0045, Japan  
Tel: +81-3-4455-3722  
Fax: +81-3-5209-6013  
Email: japan@adlinktech.com

**ADLINK Technology, Inc. (Korean Liaison Office)**

Address: 서울시 서초구 서초동 1675-12 모인터빌딩 8 층  
8F Mointer B/D, 1675-12, Seocho-Dong, Seocho-Gu,  
Seoul 137-070, Korea  
Tel: +82-2-2057-0565  
Fax: +82-2-2057-0563  
Email: korea@adlinktech.com

**ADLINK Technology Singapore Pte. Ltd.**

Address: 84 Genting Lane #07-02A, Cityneon Design Centre,  
Singapore 349584  
Tel: +65-6844-2261  
Fax: +65-6844-2263  
Email: singapore@adlinktech.com

**ADLINK Technology Singapore Pte. Ltd. (Indian Liaison Office)**

Address: 1st Floor, #50-56 (Between 16th/17th Cross) Margosa Plaza,  
Margosa Main Road, Malleswaram, Bangalore-560055, India  
Tel: +91-80-65605817, +91-80-42246107  
Fax: +91-80-23464606  
Email: india@adlinktech.com

**ADLINK Technology, Inc. (Israeli Liaison Office)**

Address: 6 Hasadna St., Kfar Saba 44424, Israel  
Tel: +972-9-7446541  
Fax: +972-9-7446542  
Email: israel@adlinktech.com