

---

# **MB-i965Q**

## **ATX Industrial Motherboard**

# **User's Manual**

## **Version 1.0**

---

This page is intentionally left blank.

---

# Table of Contents

<b>Chapter 1 - Introduction</b> .....	<b>1</b>
1.1 Copyright Notice.....	2
1.2 About this User's Manual.....	2
1.3 Warning.....	2
1.4 Replacing the lithium battery .....	3
1.5 Technical Support.....	3
1.6 Warranty .....	4
1.7 Packing List.....	5
1.8 Ordering Information.....	5
1.9 Specification .....	6
1.10 Board Dimensions.....	7
1.11 Installing the CPU .....	8
1.12 Installing the Memory.....	9
<b>Chapter 2 - Installation</b> .....	<b>11</b>
2.1 Block Diagram.....	12
2.2 Jumpers and Connectors .....	13
Jumpers.....	14
JP3: PATA IDE Select .....	14
JBAT1: CMOS Setup .....	14
JRS1: COM2 RS-232/422/485 Mode Select.....	15
JP2: AT/ATX Power Mode Select.....	16
JP1: BIOS Write Protect.....	16
Connectors.....	17
SATA1 ~4: Serial ATA Connectors.....	17
IDE1: Primary IDE Connector .....	18
TPM1: Trusted Platform Module Connector.....	19
USB1 ~3: USB Connectors .....	19
JFRT1: Switches and Indicators .....	20
COM2: RS-232/422/485 Connector.....	21
FDD1: FDD Connector.....	21
DIO1: Digital I/O Connector .....	22
CDIN1: Audio CD IN Connector.....	22

- LOUT1: Audio Line Out Connector .....22
- ATX1: ATX Power Supply Connector .....23
- ATX12V1: ATX +12V Connector.....23
- EKB1: External Keyboard/ Mouse Connector.....24
- SYSF1/SYSF2: System Fan Power Connectors..24
- CPUF1: CPU Fan Power Connector.....24
- Audio1/ Audio2: HD Audio Phone Jacks .....25
- LAN1/LAN2: RJ-45 & double stack USB  
Connectors.....25
- VGA1: CRT Connector .....26
- COM1: RS-232 Connector.....26
- LPT1: Parallel Port Connector.....27
- KBM1: PS/2 Keyboard & Mouse Connectors.....27
- 2.3 The Installation Paths of CD Driver.....28
- Chapter 3 - BIOS ..... 29**
- 3.1 BIOS Main Setup.....30
- 3.2 Advanced Settings.....31
  - CPU Configuration .....32
  - IDE Configuration .....33
  - Floppy Configuration .....34
  - Super IO Configuration .....35
  - Hardware Health Configuration.....37
  - ACPI Configuration .....38
  - APM Configuration .....39
  - MPS Configuration .....41
  - Remote Access Configuration .....42
  - Trusted Computing.....44
  - USB Configuration .....45
- 3.3 Advanced PCI/PnP Settings.....47
- 3.4 Boot Settings .....49
  - Boot Settings Configuration.....50
- 3.5 Security.....51

---

<b>3.6 Advanced Chipset Settings .....</b>	<b>53</b>
North Bridge Chipset Configuration.....	53
South Bridge Chipset Configuration .....	54
<b>3.7 Exit Options.....</b>	<b>56</b>
<b>3.8 Beep Sound codes list .....</b>	<b>61</b>
Boot Block Beep codes .....	61
POST BIOS Beep codes.....	61
Troubleshooting POST BIOS Beep codes.....	62
<b>3.9 AMI BIOS Checkpoints .....</b>	<b>63</b>
Bootblock Initialization Code Checkpoints.....	63
Bootblock Recovery Code Checkpoints .....	65
POST Code Checkpoints .....	67
DIM Code Checkpoints .....	71
ACPI Runtime Checkpoints .....	73
<b>Chapter 4 - Appendix .....</b>	<b>75</b>
4.1 I/O Port Address Map .....	76
4.2 Interrupt Request Lines (IRQ).....	77

This page is intentionally left blank.



# Chapter 1

# Introduction

## 1.1 Copyright Notice

All Rights Reserved.

The information in this document is subject to change without prior notice in order to improve the reliability, design and function. It does not represent a commitment on the part of the manufacturer.

Under no circumstances will the manufacturer be liable for any direct, indirect, special, incidental, or consequential damages arising from the use or inability to use the product or documentation, even if advised of the possibility of such damages.

This document contains proprietary information protected by copyright. All rights are reserved. No part of this manual may be reproduced by any mechanical, electronic, or other means in any form without prior written permission of the manufacturer.

## 1.2 About this User's Manual

This User's Manual is intended for experienced users and integrators with hardware knowledge of personal computers. If you are not sure about any description in this User's Manual, please consult your vendor before further handling.

## 1.3 Warning

Single Board Computers and their components contain very delicate Integrated Circuits (IC). To protect the Single Board Computer and its components against damage from static electricity, you should always follow the following precautions when handling it :

1. Disconnect your Single Board Computer from the power source when you want to work on the inside.
2. Hold the board by the edges and try not to touch the IC chips, leads or circuitry.
3. Use a grounded wrist strap when handling computer components.
4. Place components on a grounded antistatic pad or on the bag that came with the Single Board Computer, whenever components are separated from the system.



## **1.4 Replacing the lithium battery**

Incorrect replacement of the lithium battery may lead to a risk of explosion. The lithium battery must be replaced with an identical battery or a battery type recommended by the manufacturer.

Do not throw lithium batteries into the trashcan. It must be disposed of in accordance with local regulations concerning special waste.

## **1.5 Technical Support**

If you have any technical difficulties, please consult the user's manual first at:

<ftp://ftp.arbor.com.tw/pub/manual>

Please do not hesitate to call or e-mail our customer service when you still can not find out the answer.

<http://www.arbor.com.tw>

E-mail:[info@arbor.com.tw](mailto:info@arbor.com.tw)

## 1.6 Warranty

This product is warranted to be in good working order for a period of two years from the date of purchase. Should this product fail to be in good working order at any time during this period, we will, at our option, replace or repair it at no additional charge except as set forth in the following terms. This warranty does not apply to products damaged by misuse, modifications, accident or disaster.

Vendor assumes no liability for any damages, lost profits, lost savings or any other incidental or consequential damage resulting from the use, misuse of, or inability to use this product. Vendor will not be liable for any claim made by any other related party.

Vendors disclaim all other warranties, either expressed or implied, including but not limited to implied warranties of merchantability and fitness for a particular purpose, with respect to the hardware, the accompanying product's manual(s) and written materials, and any accompanying hardware. This limited warranty gives you specific legal rights.

Return authorization must be obtained from the vendor before returned merchandise will be accepted. Authorization can be obtained by calling or faxing the vendor and requesting a Return Merchandise Authorization (RMA) number. Returned goods should always be accompanied by a clear problem description.

## 1.7 Packing List



1 x MB-i965Q ATX Industrial Motherboard



1 x Driver CD



1 x Quick Installation Guide

COM Port Cable x 1  
 IDE Cable x 1  
 USB Cable x 1  
 SATA Cable x 2

If any of the above items is damaged or missing, contact your vendor immediately.

## 1.8 Ordering Information

MB-i965Q	ATX Industrial Motherboard
Cable Kit	CBK-04-965Q-00

## 1.9 Specifications

Form Factor	ATX Industrial Motherboard
Processor	Socket for Intel® Core™ 2 Duo/ Pentium® D/ Celeron® D/ Pentium® 4 processor, with 1066/800/533MHz FSB, w/ HT
Chipset	Intel® Q965 + Intel® ICH8R
System Memory	2 x 240-pin DIMM socket up to 4GB
VGA Controller	Intel® Graphics Media Accelerator (GMA) 3000 graphics core w/ CRT (Dual independent display)
Ethernet	2 x Realtek 8111B 10/100/1000 base-T Ethernet
I/O Chips	ITE-8718
BIOS	AMI PnP Flash BIOS
Audio	ALC888 HD Codec 7.1 channel/MIC-in/Line-in/Line-out
Serial ATA	4 x Serial ATA with 300MB/s HDD transfer rate
IDE Interface	1 x ATA 66/100, support 1 IDE device
Serial Port	2 x COM port (COM1: RS-232, COM2: RS-232/422/485)
Parallel Port	1 x SPP/EPP/ECP mode
FDD	1 x Slim type Floppy connector
KBMS	PS/2 Keyboard and Mouse
External KBMS	1 x 6-pin wafer connector
Universal Serial Bus	10 x USB 2.0 (6 ports by pin header)
Digital I/O	Onboard 8-bit Digital I/O Interface
Expansion Interface	1 x PCIe*16 slot, 5 x PCI slot, 1 x ISA slot
Hardware Monitor Chip	<ul style="list-style-type: none"> <li>◆ CPU/System temperature and over heat Alarm</li> <li>◆ 12V/5V/3.3V/Vcore/Vbat/5Vsb/3.3Vsb Voltage</li> <li>◆ CPU/System Fan speed</li> <li>◆ CPU over heat Protection</li> </ul>
RTC	Real Time Clock
Power Input Connector	24-pin ATX power connector & +12V 4-pin ATX Power Connector
Operating Temp.	0°C ~ 60°C (-32°F ~ 140°F)
Watchdog Timer	255-level Reset
Dimension (L x W)	305 x 220mm (12" x 8.6")

## 1.10 Board Dimensions

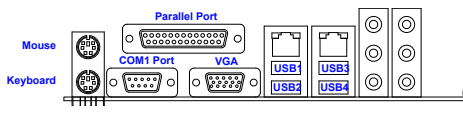
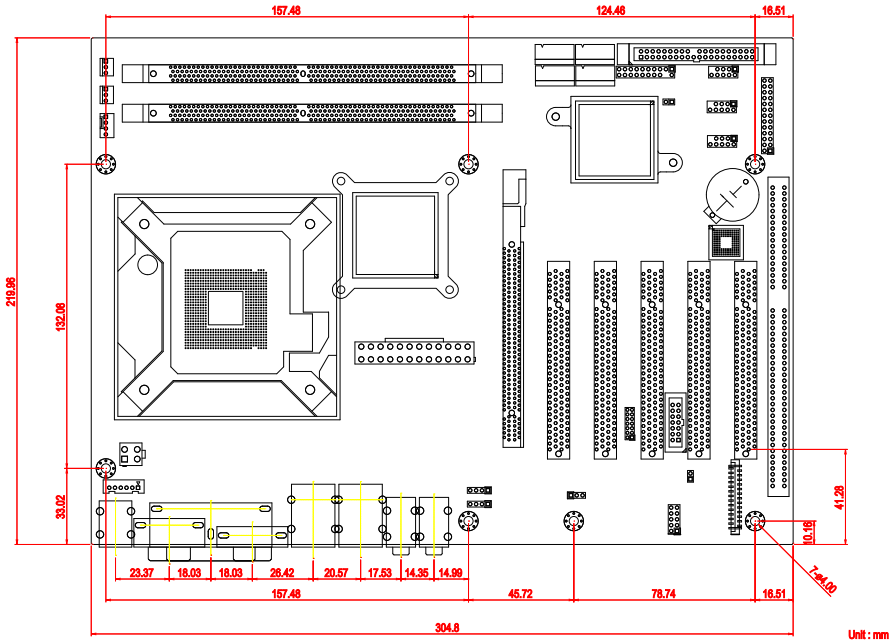

## 1.11 Installing the CPU

The LGA775 processor socket comes with a lever to secure the processor. Please refer to the pictures step by step as below. Please note that the cover of the LGA775 socket must always be installed during transport to avoid damage to the socket.

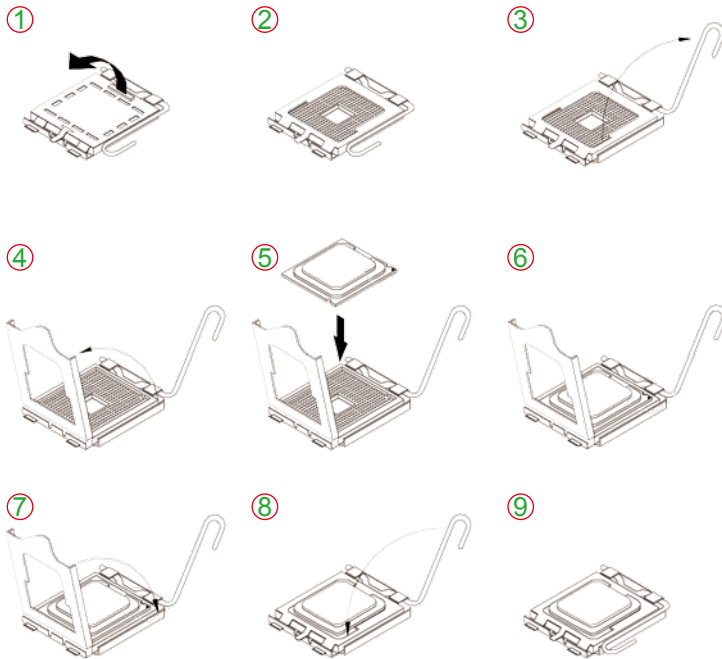

Make sure that heat sink of the CPU top surface is in complete contact to avoid the CPU overheating problem.

If not, it would cause your system or CPU to be hanged, unstable, damaged.

## 1.12 Installing the Memory

To install the Memory module, locate the Memory DIMM slot on the board and perform as below:

1. Hold the Memory module so that the key of the Memory module align with those on the Memory DIMM slot.
2. Gently push the Memory module in an upright position and a right way until the clips of the DIMM slot close to lock the Memory module in place, when the Memory module touches the bottom of the DIMM slot.
3. To remove the Memory module, just pressing the clips of DIMM slot with both hands.

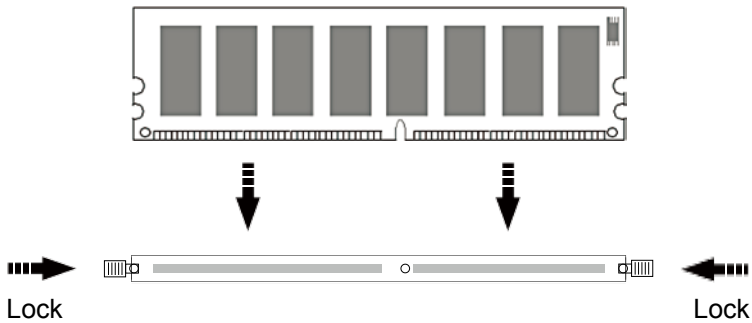

This page is intentionally left blank.





# Chapter 2

# Installation

## 2.1 Block Diagram

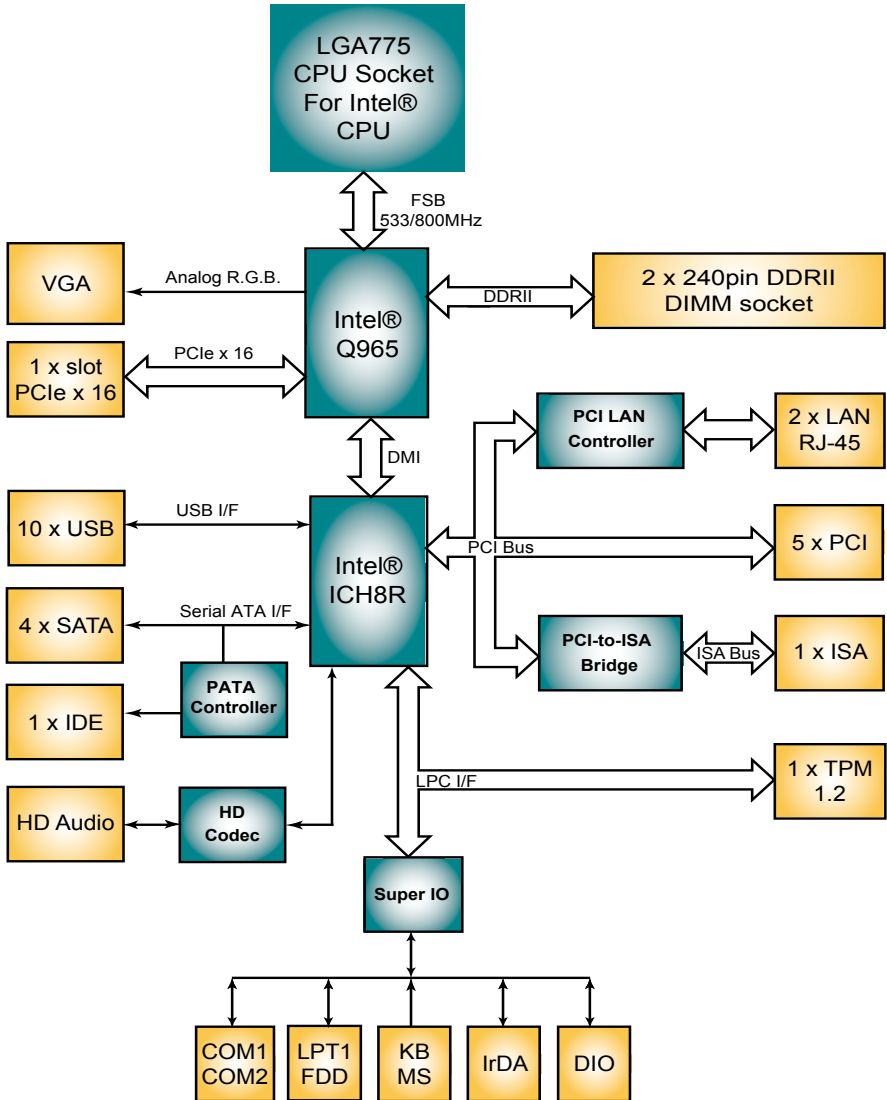

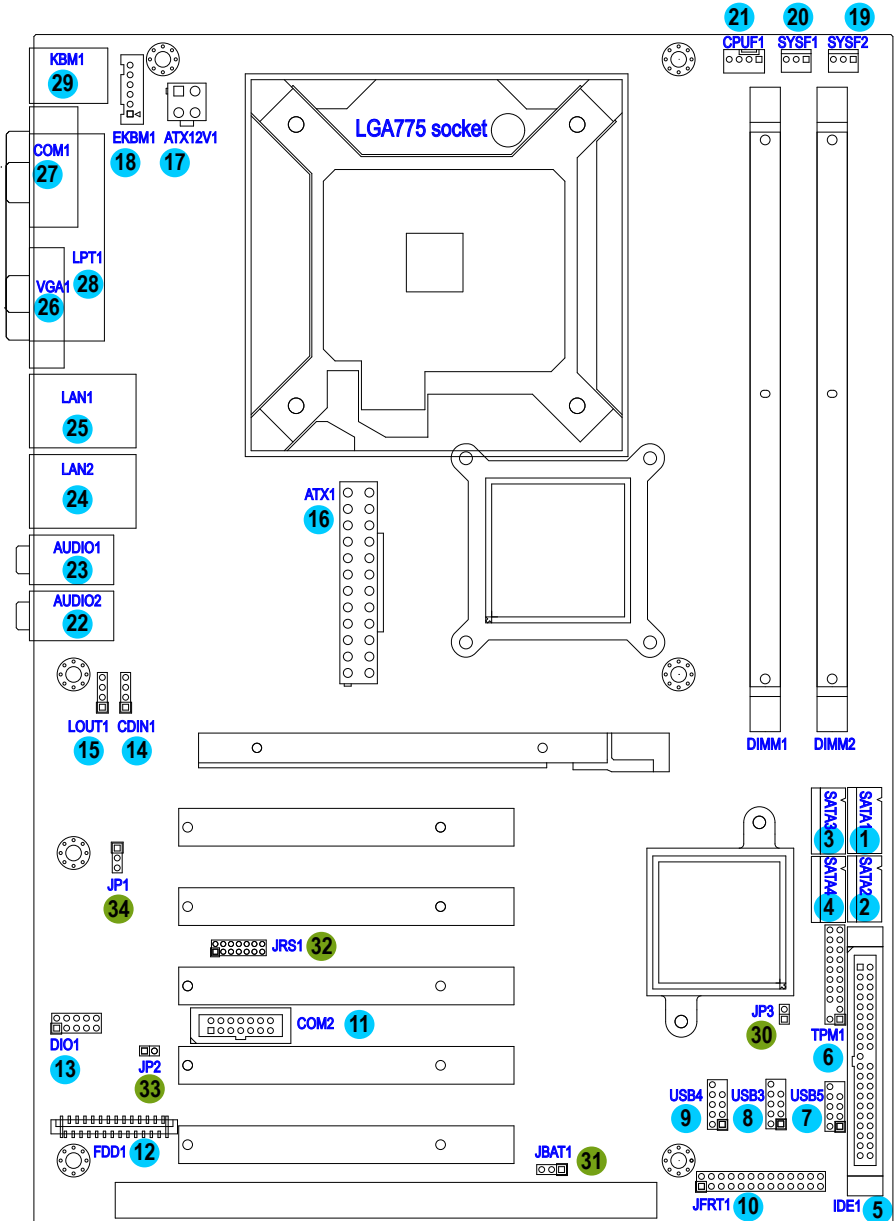

## 2.2 Jumpers and Connectors



## Jumpers

### JP3: PATA IDE Select (30)



Connector type: 2.54mm pitch 1x2 pin header.

Pin 1-2	Function Select	
Short	Disable	
Open	Enable (Default)	

### JBAT1: CMOS Setup (31)

If the board refuses to boot due to inappropriate CMOS settings here is how to proceed to clear (reset) the CMOS to its default values.

Connector type: 2.54mm pitch 1x3 pin header

Pin	Mode	
1-2	Keep CMOS (Default)	
2-3	Clear CMOS	

You may need to clear the CMOS if your system cannot boot up because you forgot your password, the CPU clock setup is incorrect, or the CMOS settings need to be reset to default values after the system BIOS has been updated.

Refer to the following solutions to reset your CMOS setting:

#### Solution A:

1. Power off the system and disconnect the power cable.
2. Place a shunt to short pin 1 and pin 2 of JBAT1 for five seconds.
3. Place the shunt back to pin 2 and pin 3 of JBAT1.
4. Power on the system.

#### Solution B:

If the CPU Clock setup is incorrect, you may not be able to boot up. In this case, follow these instructions:

1. Turn the system off, then on again. The CPU will automatically boot up using standard parameters.
2. As the system boots, enter BIOS and set up the CPU clock.

#### Note:

If you are unable to enter BIOS setup, turn the system on and off a few times.

### JRS1: COM2 RS-232/RS-422/RS-485 Mode Select (32)

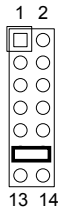

Connector type: 2.00 mm pitch 2x7 pin header

Mode	RS-232 (Default)	RS-422	RS-485
1-2	Off	On	On
3-4	Off	On	On
5-6	Off	Off	On
7-8	Off	On	Off
9-10	Off	On	On
11-12	On	Off	Off
13-14	Off	Off	On





### JP2: AT/ATX Power Mode Select (33)

The power mode jumper selects the power mode for the system.  
Connector type: 2.54mm pitch 1x2 pin header.

Pin 1-2	Mode	
Short	AT Mode	
Open	ATX Mode (Default)	

### JP1: BIOS Write protect (34)

Connector type: 2.54mm pitch 1x3 pin header.

Pin	Mode	
1-2	Write protect (default)	
2-3	Write Enable	

## Connectors

### SATA1~4: Serial ATA Connectors (1), (2), (3), (4)

There are on board supports four SATA II connectors, second generation SATA drives transfer data at speeds as high as 300MB/s, twice the transfer speed of first generation SATA drives. The SATA drives can be configured in a RAID 0, RAID 1 or RAID 10 configuration.

Pin	Description
1	GND
2	TX+
3	TX-
4	GND
5	RX-
6	RX+
7	GND

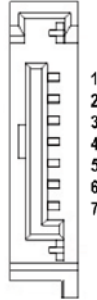

### IDE1: Primary IDE Connector (5)

An IDE drive ribbon cable has two connectors to support two IDE devices. If a ribbon cable connects to two IDE drives at the same time, one of them has to be configured as Master and the other has to be configured as Slave by setting the drive select jumpers on the drive.

Consult the documentation that came with your IDE drive for details on jumper locations and settings. You must orient the cable connector so that the pin 1 (color) edge of the cable corresponds to pin 1 of the IDE connector.

Connector type: 2.54mm pitch 2x20 box header

Pin	Description	Pin	Description
1	IDE RESET	2	GND
3	DATA7	4	DATA8
5	DATA6	6	DATA9
7	DATA5	8	DATA10
9	DATA4	10	DATA11
11	DATA3	12	DATA12
13	DATA2	14	DATA13
15	DATA1	16	DATA14
17	DATA0	18	DATA15
19	GND	20	N/C (Key)
21	REQ	22	GND
23	IO WRITE	24	GND
25	IO READ	26	GND
27	IO READY	28	IDESEL
29	DACK	30	GND
31	IRQ14	32	N/C
33	ADDR1	34	ATA66 DETECT
35	ADDR0	36	ADDR2
37	CS0#	38	CS1# (HDSELET1)
39	IDEACTP	40	GND

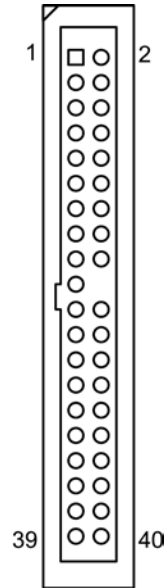



## TPM1: Trusted Platform Module Connector (6)

The TPM connector on the EmCORE-i35Q is interfaced to the Intel ICH9 south bridge through the LPC bus. The ICH9 supports TPM version 1.2 devices for enhanced security.

Connector type: 2.54mm pitch 2x10 pin header

Pin	Description	Pin	Description
1	CLK	2	GND
3	LFRAME	4	N/C
5	LRESET	6	N/C
7	LAD3	8	LAD2
9	+3.3V	10	LAD1
11	LAD0	12	GND
13	N/C	14	N/C
15	+3.3V_SB	16	SERIRQ
17	GND	18	CLKRUN
19	PD	20	N/C

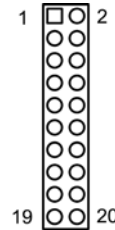

## USB1/ USB2/ USB3: USB Connectors (7), (8), (9)

On board supports three headers USB1, USB2, and USB3 that can connect up to six high-speed (Data transfers at 480MB/s), full-speed (Data transfers at 12MB/s) or low-speed (Data transfers at 1.5MB/s) USB devices.

Connector type: 2.54mm 2x5 pin header

Pin	Description	Pin	Description
1	+5V	2	+5V
3	USBD-	4	USBD-
5	USBD+	6	USBD+
7	GND	8	GND
9	N/C (Key)	10	N/C

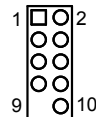

## JFRT1: Switches and Indicators (10)

It provides connectors for system indicators that provides light indication of the computer activities and switches to change the computer status.

Connector type: 2.54mm pitch 2x13 pin header

Pin	Description	Pin	Description
1	+5V	2	RESET+
3	N/C	4	RESET-
5	IRRX	6	N/C
7	GND	8	SPKR
9	IRTX	10	BUZZ
11	N/C	12	GND
13	HDD_LED+	14	+5V
15	HDD_LED-	16	N/C
17	TB_LED+	18	POWER_LED+
19	TB_LED-	20	N/C
21	N/C	22	POWER_LED-
23	PWRBTN+	24	KBLOCK
25	PWRBTN-	26	GND

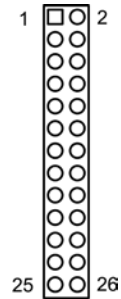

IrDA: Infrared connector, pin 1, 3, 5, 7, 9

HLED: HDD LED Connector, pin 13-15.

This 2-pin connector connects to the case-mounted HDD LED to indicate hard disk activity.

RES: Reset Button, pin 2-4.

This 2-pin connector connects to the case-mounted reset switch and is used to reboot the system.

TB\_LED: pin 17-19

PWRBTN: ATX soft power switch, pin 23-25.

This 2-pin connector connects to the case-mounted Power button.

PLED: Power LED Connector, pin 18, 20, 22.

This 3-pin connector connects to the case-mounted power LED. Power LED can be indicated when the CPU card is on or off. And keyboard lock can be used to disable the keyboard function so the PC will not respond by any input.

SPK: External Speaker, pin 8, 10, 12, 14.

This 4-pin connector connects to the case-mounted speaker.

KBLOCK: Keyboard Lock, pin 24-26.

## COM2: RS-232/422/485 Connector (11)

The onboard COM2 port can be configured to operate in RS-422 or RS-485 modes. RS-422 modes differ in the way RX/TX is being handled. Jumper JRS1 switches between RS-232 or RS-422/485 mode. All of the RS-422/485 are available on COM2.

Connector type: 2.54mm pitch 2x7 box header.

Pin	Description	Pin	Description
1	DCD2#	2	DSR2#
3	RXD2	4	RTS2#
5	TXD2	6	CTS2#
7	DTR2#	8	RI2#
9	GND	10	GND
11	TX+	12	TX-
13	RX+	14	RX-

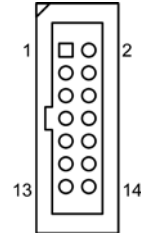

## FDD1: FDD Connector (12)

Pin	Description	Pin	Description
1	+5V	2	INDEX#
3	+5V	4	DRIVER SELECT A#
5	+5V	6	DISK CHANGE#
7	N/C	8	N/C
9	N/C	10	MOTOR ENABLE A#
11	N/C	12	DIRECTION#
13	DRIVE DENSITY SELECT 0	14	STEP#
15	GND	16	WRITE DATA#
17	GND	18	WRITE GATE#
19	GND	20	TRACK0#
21	GND	22	WRITE PROTECT#
23	GND	24	READ DATA#
25	GND	26	HEAD SELECT#

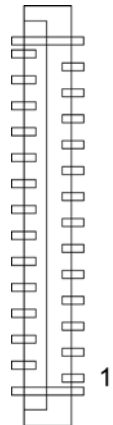

### DIO1: Digital I/O Connector (13)

DIO1 is a 8-bit DIO connector that supports 4-bit In/ 4-bit Out.

Connector type: 2.54mm pitch 2x5 pin header

Pin	Description	Pin	Description
1	OUTPUT1	2	INPUT1
3	OUTPUT2	4	INPUT2
5	OUTPUT3	6	INPUT3
7	OUTPUT4	8	INPUT4
9	+5V	10	GND

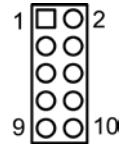

### CDIN1: Audio CD IN Connector (14)

Connector type: 2.54mm pitch 1x4 pin header.

Pin	Description
1	CD-L
2	GND
3	GND
4	CD-R

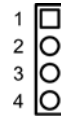

### LOUT1: Audio Line Out Connector (15)

Connector type: 2.54mm pitch 1x4 pin header.

Pin	Description
1	LOUT-L
2	GND
3	LOUT_JD
4	LOUT-R

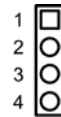

## ATX1: ATX Power Supply Connector (16)

The ATX power supply has a single lead connector with a clip on one side of the plastic housing. There is only one way to plug the lead into the ATX power connector. Press the lead connector down until the clip snaps into place and secures the lead onto the connector.

Pin	Description	Pin	Description
13	+3.3V	1	+3.3V
14	-12V	2	+3.3V
15	GND	3	GND
16	PS-ON	4	+5V
17	GND	5	GND
18	GND	6	+5V
19	GND	7	GND
20	-5V	8	PW-OK
21	+5V	9	+5VSB
22	+5V	10	+12V
23	+5V	11	+12V
24	GND	12	+3.3V

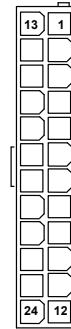

### Warning

Incorrect installation of the power supply could result in serious damage to the mainboard and connected peripherals. Make sure the power supply is unplugged from the AC outlet before connecting the leads from the power supply.

## ATX12V1: ATX +12V Connector (17)

Pin	Description	Pin	Description
2	GND	1	GND
4	+12V	3	+12V

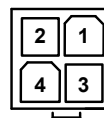

ATX12V1 supplies the CPU operation ATX +12V (Vcore).

### EKBM1: External keyboard and Mouse Connector (18)

Connector type: 2.50mm pitch 1x6-pin box wafer connector

Pin	Description
1	KB_Data
2	GND
3	MS_Data
4	KB_Clock
5	+5V
6	MS_Clock

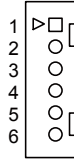

### SYSF1/SYSF2: System Fan Power Connectors (19), (20)

SYSF1 and SYSF2 are 3-pin header for the system fan. The fan must be a +12V fan.

Pin	Description
1	GND
2	+12V
3	FAN_Detect

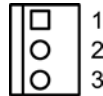

### CPUF1: CPU Fan Power Connector (21)

CPUF1 is a 4-pin header for the CPU fan. The fan must be a +12V fan.

Pin	Description
1	GND
2	+12V
3	Fan_Detect
4	Fan Speed Control

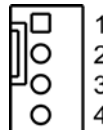

## Audio1/ Audio2: HD Audio Phone Jacks (22), (23)

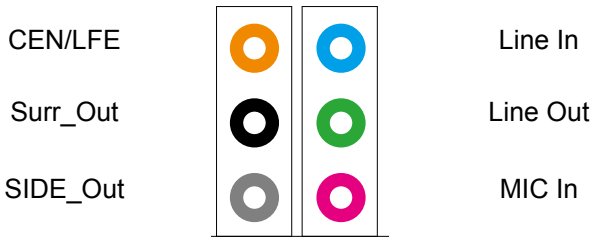

## LAN1/LAN2: RJ-45 & double stack USB Connectors (24), (25)

LAN1/ LAN2 each one supports one 10/100/1000 Mbps fast Ethernet and two USB 2.0 connectors w/ 480MB/s.

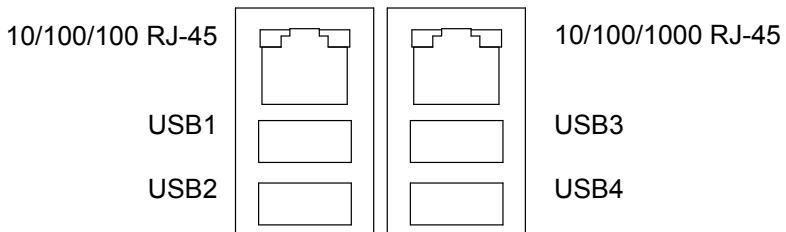

### VGA1: CRT Connector (26)

Connector type: D-Sub 15-pin female.

Pin	Description	Pin	Description
1	RED	9	+5V
2	GREEN	10	GND
3	BLUE	11	N/C
4	N/C	12	VDDAT
5	GND	13	HSYNC
6	GND	14	VSYNC
7	GND	15	VDCLK
8	GND		

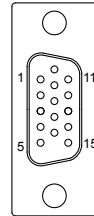

### COM1: RS-232 Connector (27)

Connector type: D-Sub 9-pin male.

Pin	Description	Pin	Description
1	DCD#	6	DSR#
2	RXD	7	RTS#
3	TXD	8	CTS#
4	DTR#	9	RI#
5	GND		

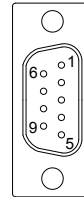



### LPT1: Parallel Port Connector (28)

Connector type: D-Sub 25-pin female.

Pin	Description	Pin	Description
1	STROBE	14	AFD
2	PTD0	15	ERROR
3	PTD1	16	INIT
4	PTD2	17	SLIN
5	PTD3	18	GND
6	PTD4	19	GND
7	PTD5	20	GND
8	PTD6	21	GND
9	PTD7	22	GND
10	ACK	23	GND
11	BUSY	24	GND
12	PE	25	GND
13	SELECT	26	N/C

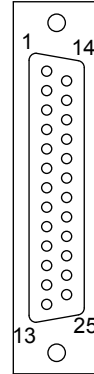

### KBM1: PS/2 Keyboard & Mouse (29)

Standard Mini-DIN PS/2 Keyboard & Mouse connector

Pin	Description
1	KB Data
2	N/C
3	GND
4	+5V
5	KB Clock
6	N/C
7	MS Data
8	N/C
9	GND
10	+5V
11	MS Clock
12	N/C

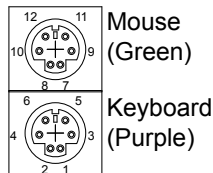

## 2.3 The Installation Paths of CD Driver

Driver	Path
AUDIO	\AUDIO\REALTEK_HD\WINDOWS_R178
CHIPSET	\CHIPSET\INTEL\INF 8.1
LAN	\ETHERNET\REALTEK\8111B_WIN5640
VGA	\GRAPHICS\INTEL_2K_XP_32\1431 \GRAPHICS\INTEL_VISTA_32\1561

# Chapter 3

# BIOS

### 3.1 BIOS Main Setup

The AMI BIOS provides a Setup utility program for specifying the system configurations and settings. The BIOS ROM of the system stores the Setup utility.

When you turn on the computer, the AMI BIOS is immediately activated. The Main allows you to select several configuration options. Use the left/right arrow keys to highlight a particular configuration screen from the top menu bar or use the down arrow key to access and configure the information below.

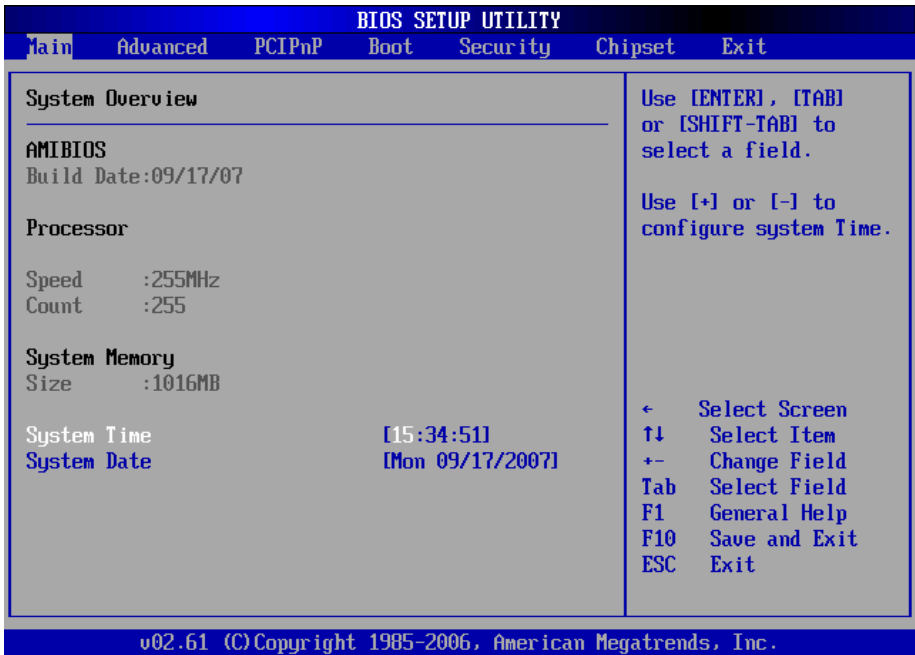

#### System Time

Set the system time.  
The time format is:

- Hour** : 00 to 23
- Minute** : 00 to 59
- Second** : 00 to 59

## System Date

Set the system date. Note that the 'Day' automatically changes when you set the date.

The date format is:

- Day** : Sun to Sat
- Month** : 1 to 12
- Date** : 1 to 31
- Year** : 1999 to 2099

## 3.2 Advanced Settings

BIOS SETUP UTILITY	
Main	Advanced
PCIPnP	Boot
Security	Chipset
Exit	
Advanced Settings <hr/> WARNING: Setting wrong values in below sections may cause system to malfunction.  ▶ CPU Configuration ▶ IDE Configuration ▶ Floppy Configuration ▶ SuperIO Configuration ▶ Hardware Health Configuration ▶ ACPI Configuration ▶ APM Configuration ▶ MPS Configuration ▶ Remote Access Configuration ▶ Trusted Computing ▶ USB Configuration	Configure CPU.         ← Select Screen ↑↓ Select Item Enter Go to Sub Screen F1 General Help F10 Save and Exit ESC Exit
v02.61 (C) Copyright 1985-2006, American Megatrends, Inc.	

## CPU Configuration

The CPU Configuration setup screen varies depending on the installed processor.

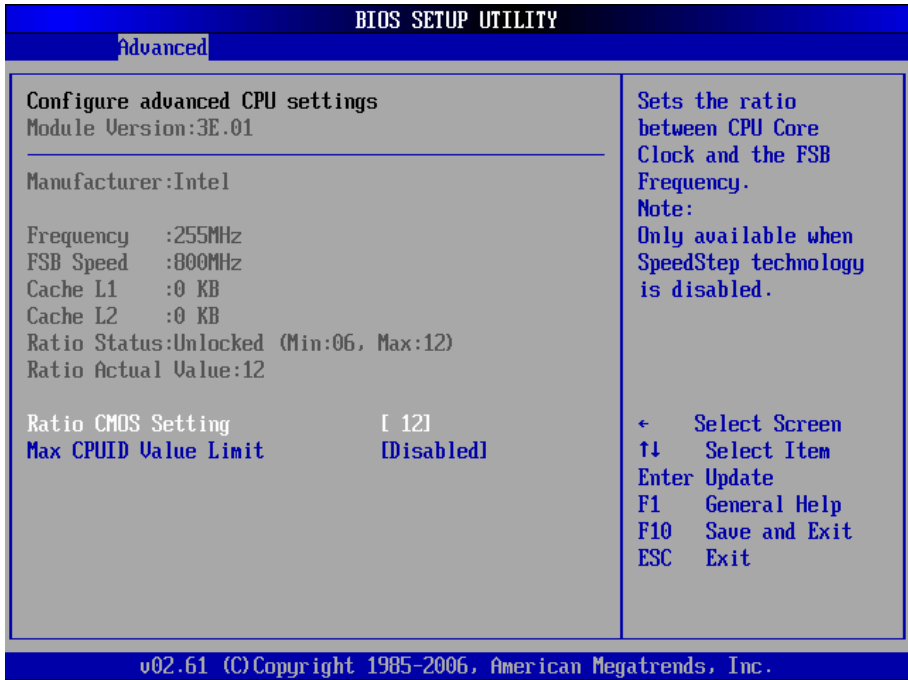

### Ratio CMOS Setting

Sets the ratio between CPU Core Clock and the FSB Frequency.

Note: Only available when SpeedStep Technology is disabled.

### Max CPUID Value Limit

Disabled for Windows XP.

## IDE Configuration

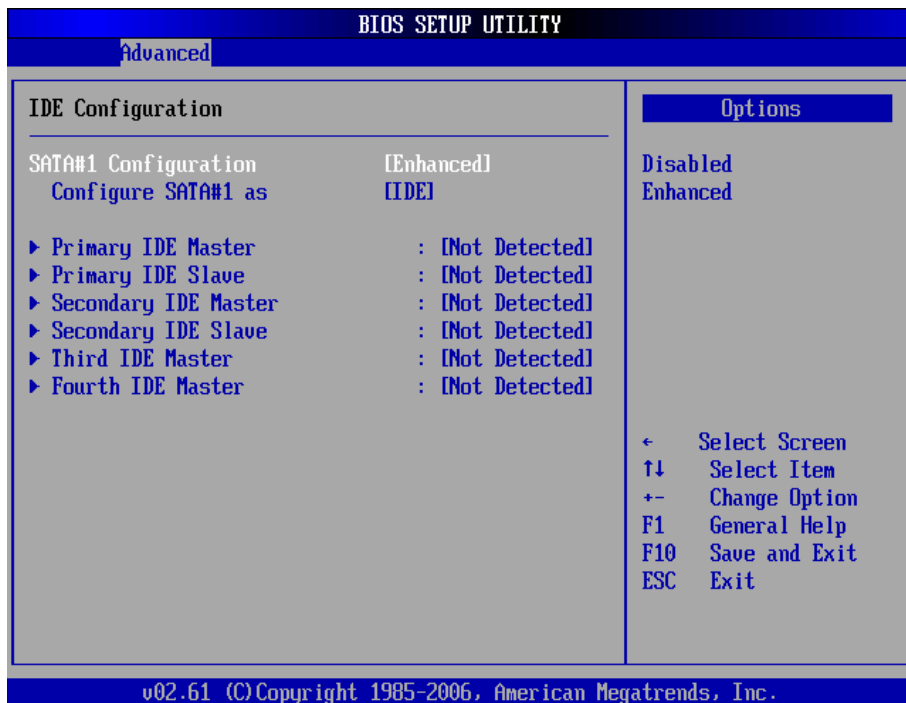

### SATA#1 Configuration

Enable - Enable SATA configuration.

Disabled - Disable SATA configuration

### Configure SATA#1 as

This BIOS feature controls the SATA controller's operating mode.

There are two available modes - IDE and RAID. When set to:

RAID - the SATA controller **enables** its RAID and AHCI functions when the computer boots up.

IDE - the SATA controller **disables** its RAID and AHCI functions when the computer boots up.

### Primary/Secondary IDE Master/Slave, Third/ Fourth IDE master

Select one of the hard disk drives to configure it. Press <Enter> to access its the sub menu.

## Floppy Configuration



Select the type of floppy disk drive installed in your system.

The choice:

- None
- 360K 5.25"
- 1.2M 5.25"
- 720K 3.5"
- 1.44M 3.5"
- 2.88M 3.5"



## Super IO Configuration

BIOS SETUP UTILITY	
Advanced	
Configure ITE8718 Super IO Chipset	
OnBoard Floppy Controller	[Enabled]
Serial Port1 Address	[3F8/IRQ4]
Serial Port2 Address	[2F8/IRQ3]
Serial Port2 Mode	[Normal]
Parallel Port Address	[378]
Parallel Port Mode	[Normal]
Parallel Port IRQ	[IRQ7]
Restore on AC Power Loss by IO	[Last State]
Allows BIOS to Enable or Disable Floppy Controller.	
← Select Screen ↑↓ Select Item +- Change Option F1 General Help F10 Save and Exit ESC Exit	
v02.61 (C) Copyright 1985-2006, American Megatrends, Inc.	

### Onboard Floppy Controller

Select "Enabled" if your system has a floppy disk controller (FDC) installed on the system board and you wish to use it. If you install and-in FDC or the system has no floppy drive, select Disabled in this field.

The Choice: Enabled, Disabled

### Serial Port1 / Port2 Address

Select an address and corresponding interrupt for the first and second serial ports.

The choice:

- 3F8/IRQ4
- 2E8/IRQ3
- 3E8/IRQ4
- 2F8/IRQ3
- Disabled
- Auto

### **Serial Port2 Mode**

Allows BIOS to select mode for serial Port2.

### **Parallel Port Address**

Select an address for the parallel port.

The choice:

- 3BC
- 378
- 278
- Disabled

### **Parallel Port Mode**

Select an operating mode for the onboard parallel port. Select Normal, Compatible or SPP unless you are certain your hardware and software both support one of the other available modes.

The choice:

- SPP
- EPP
- ECP
- ECP + EPP
- Normal

### **Parallel Port IRQ**

Select an interrupt for the parallel port.

The choice:

- IRQ5
- IRQ7

### **Restore on AC Power Loss by IO**

This item allows you to select if you want to power on the system after power failure.

## Hardware Health Configuration

BIOS SETUP UTILITY	
Advanced	
<b>Hardware Health Configuration</b>	
H/W Health Function	[Enabled]
CPU Fan Mode Setting	[Full On mode]
System Temperature	:30°C/86°F
CPU Temperature	:29°C/84°F
System Fan Speed	:N/A
CPU Fan Speed	:4591 RPM
Chassis Fan Speed	:N/A
VDIMM	:1.808 V
Vcore	:1.264 V
+3.30V	:3.280 V
+5.00V	:4.838 V
+12.0V	:11.840 V
-12.0V	:-12.052 V
5Vsb	:4.945 V
VBAT	:3.072 V
+ Select Screen ↑↓ Select Item +- Change Option F1 General Help F10 Save and Exit ESC Exit	
v02.61 (C) Copyright 1985-2006, American Megatrends, Inc.	

### H/W Health Function

Enables Hardware Health Monitoring Device.

### CPU FAN Mode Setting

This item allows you to set CPU fan speed control mode.

### System / CPU / Chassis Fan Speed

Show you the current System / CPU / Chassis Fan operating speed.

### VDIMM

Show you the voltage level of the DRAM.

## Vcore

Show you the voltage level of CPU (Vcore).

**+3.30V / +5.00V / +12.0V / -12.0V / 5Vsb / VBAT**

Show you the voltage level of the +3.3V, +5.0V, +12.0V, -12.0V, +5V standby and battery.

## ACPI Configuration

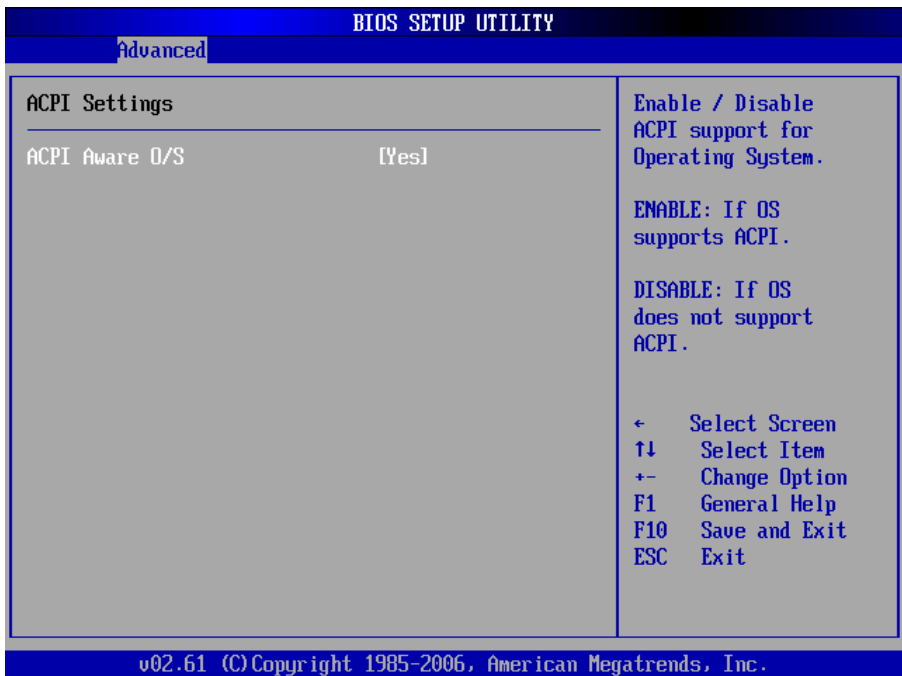

## ACPI Aware O/S

This item allows you to enable/disable the Advanced Configuration and Power Management (ACPI)

The Choice: Enabled, Disabled.

## APM Configuration

BIOS SETUP UTILITY	
Advanced	
<b>APM Configuration</b>	
Power Management/APM	[Enabled]
Video Power Down Mode	[Disabled]
Hard Disk Power Down Mode	[Disabled]
Suspend Time Out	[Disabled]
Throttle Slow Clock Ratio	[50%]
Keyboard & PS/2 Mouse	[MONITOR]
Power Button Mode	[On/Off]
<b>Advanced Resume Event Controls</b>	
Resume On Ring	[Disabled]
Resume On PME#	[Disabled]
Resume On RTC Alarm	[Disabled]
Enable or disable APM. ← Select Screen ↑↓ Select Item +- Change Option F1 General Help F10 Save and Exit ESC Exit	
v02.61 (C) Copyright 1985-2006, American Megatrends, Inc.	

### Power Management/APM

This category allows you to select the type (or degree) of power saving and is directly related to the following modes:

1. HDD Power Down
2. Doze Mode
3. Suspend Mode

### Video Power Down Mode

This option defines the level of power-saving mode requires in to power down the video display. As a default, the video powers down both in suspend mode and standby mode.

The Choice: Enabled, Disabled

### Hard Diks Power Down Mode

Power Down Hard Disk in Suspend or Standby Mode.

The Choice: Enabled, Disabled

### **Suspend Time Out**

Go into Suspend in the specified time.

The Choice: Enabled, Disabled

### **Throttle Slow Clock Ratio**

Select the Duty Cycle in Throttle mode.

The choice:

12.5%

25.0%

37.5%

50.0%

62.5%

75.0%

87.5%

### **Keyboard & PS/2 Mouse**

Monitor KBC ports 60/64.

### **Power Button Mode**

Pressing the power button for more than 4 seconds forces the system to enter the Soft-Off state when the system has “hang”.

The Choice: Delay 4 Sec, On/Off

### **Advanced Resume Event Controls**

#### **Resume On Ring**

An input signal on the serial Ring Indicator (RI) line (in other words an incoming call on the modem) awakens the system from a soft off state.

The Choice: Enabled, Disabled

#### **Resume On PME#**

An input signal from a PME on the PCI card awakens the system from a soft off state.

The Choice: Enabled, Disabled

#### **Resume On RTC Alarm**

When “Enabled”, you can set the date and time at which the RTC (real-time clock) alarm awakens the system from Suspend mode.

The Choice: Enabled, Disabled

## MPS Configuration

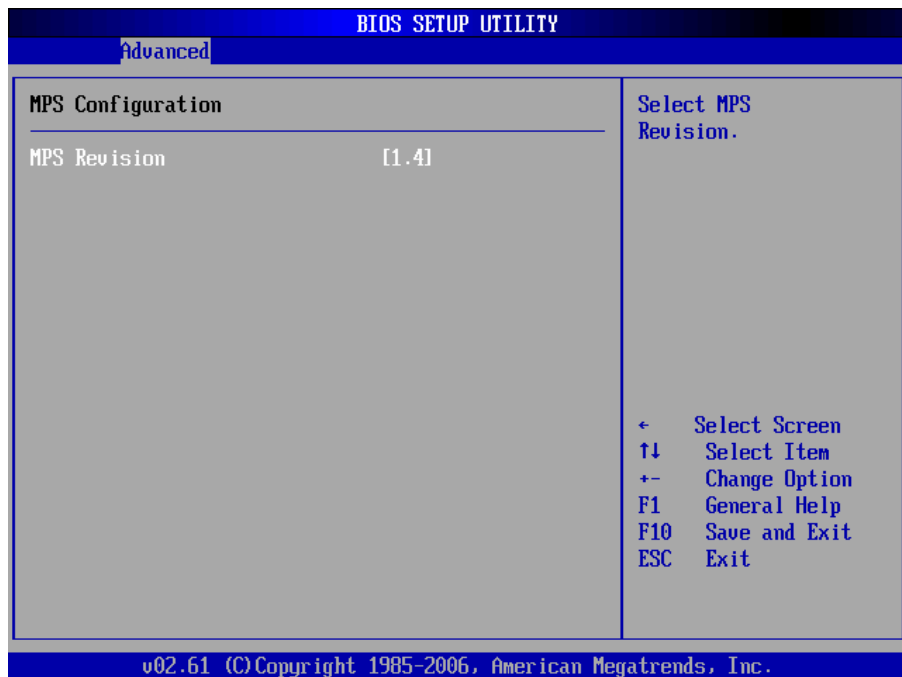

### MPS Revision

Select the operating system that is Multi-Processors Version Control for OS.  
The Choice: 1.4, 1.1.

## Remote Access Configuration

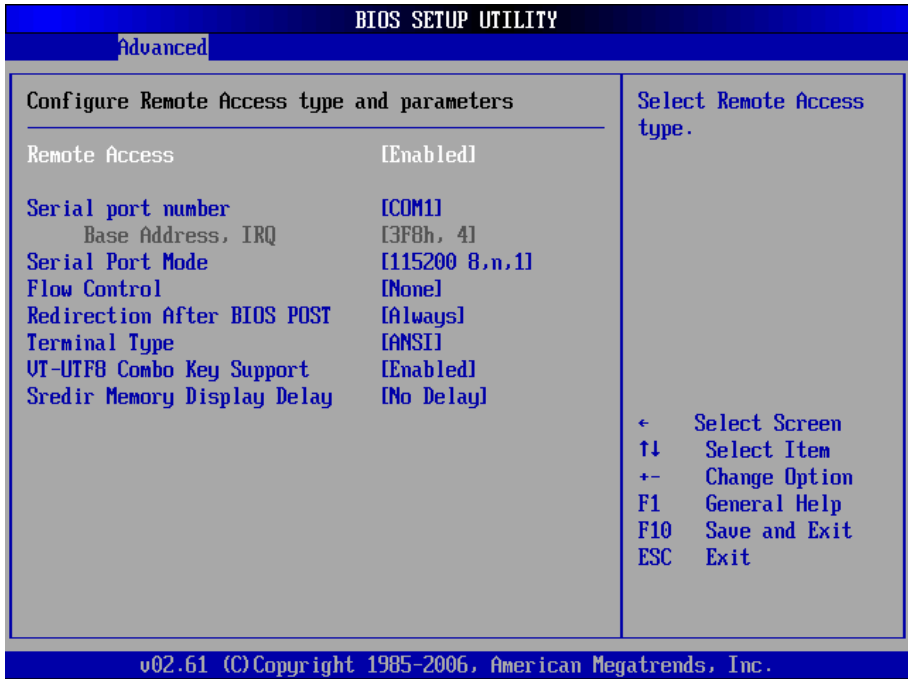

### Remote Access

Configure Remote Access type and parameters.

The Choice: Enabled, Disabled.

### Serial port number

Select Serial Port for console redirection. Make sure the selected port is enabled.

The Choice: COM1, COM2.

### Base Address, IRQ

Select Serial Port for console redirection. Make sure the selected port is enabled.

The Choice:

- 3F8, IRQ4
- 2E8, IRQ3
- 3E8, IRQ4
- 2F8, IRQ3



## Serial Port Mode

Select Serial Port settings.

## Flow Control

Select Flow Control for console redirection.

## Redirection After BIOS POST

**Disable:** Turns off the redirection after POST BOOT Loader, redirection is active during POST and during BOOT Loader.

**Always:** Redirection is always active. (Note: Some OSs may not work if set to Always)

Enable: Keep it, Disabled: Deactivate

## Terminal Type

Select the target terminal type.

## VT-UTF8 Combo Key Support

Enable VT-UTF8 Combination Key Support for ANSI/VT100 terminals.

## Sredir Memory Display Delay

Gives the delay in seconds to display memory information.

## Trusted Computing

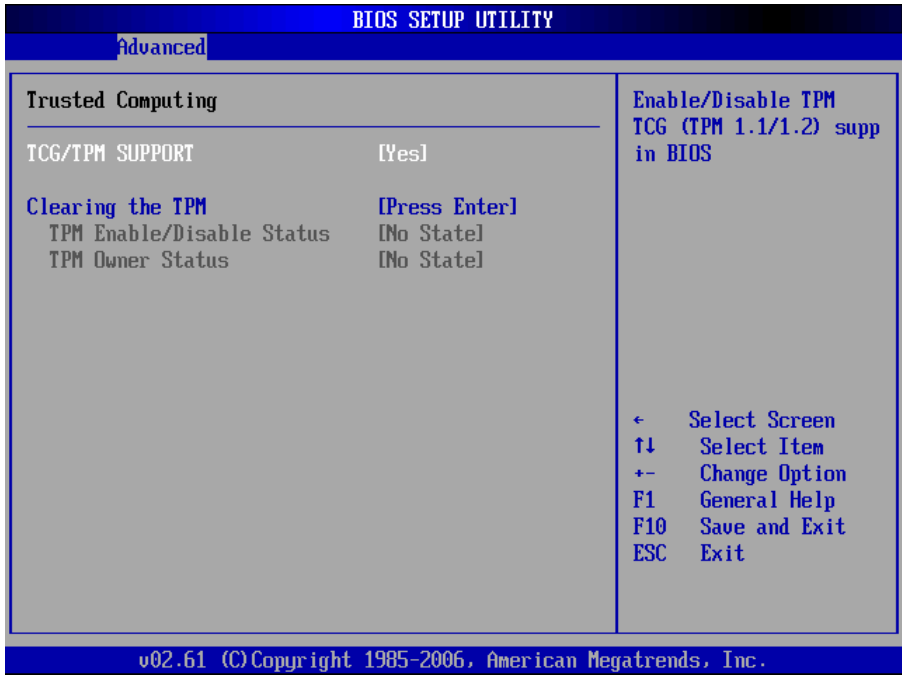

### TCG/TPM Support

Enable/Disable TPM / TCG (TPM 1.1/1.2) supports in BIOS.

## USB Configuration

BIOS SETUP UTILITY	
Advanced	
<b>USB Configuration</b> <hr/> Module Version - 2.24.0-12.4  <b>USB Devices Enabled :</b> 1 Drive  Legacy USB Support           [Enabled] Port 64/60 Emulation        [Disabled] USB 2.0 Controller Mode    [HiSpeed] BIOS EHCI Hand-Off        [Enabled]	Enables support for legacy USB. AUTO option disables legacy support if no USB devices are connected.
<b>► USB Mass Storage Device Configuration</b>	← Select Screen ↑↓ Select Item +- Change Option F1 General Help F10 Save and Exit ESC Exit
v02.61 (C) Copyright 1985-2006, American Megatrends, Inc.	

### **Legacy USB Support**

Enables support for legacy USB. AUTO option disables legacy support if no USB devices are connected.

### **Port 64/60 Emulation**

Enables I/O port 60h/64h emulation support. This should be enabled for the complete USB keyboard legacy support for non-USB aware OSs.

### **USB 2.0 Controller Mode**

Configures the USB 2.0 controller in High Speed (480Mbps) or Full Speed (12MBPS).

### **BIOS EHCI Hand-Off**

This is a work around for OSs without EHCI hand-Off support. The EHCI ownership change should claim by EHCI driver.

### **USB Mass Storage Reset Delay**

Number of seconds POST waits for the USB mass storage device after start unit command.

### **Emulation Type**

If Auto, USB devices less than 530MB will be emulated as Floppy and remaining as hard drive. Forced FDD option can be used to force a HDD formatted drive to BOOT as FDD. (Ex. ZIP drive).

### 3.3 Advanced PCI/PnP Settings

BIOS SETUP UTILITY						
Main	Advanced	PCI/PnP	Boot	Security	Chipset	Exit
Advanced PCI/PnP Settings						▲ Clear NVRAM during System Boot.
WARNING: Setting wrong values in below sections may cause system to malfunction.						
Clear NVRAM		[No]				
Plug & Play O/S		[No]				
PCI Latency Timer		[64]				
Allocate IRQ to PCI UGA		[Yes]				
PCI IDE BusMaster		[Enabled]				
Spread Spectrum Function		[Enabled]				
IRQ3		[Available]				
IRQ4		[Available]				
IRQ5		[Available]				
IRQ7		[Available]				
IRQ9		[Available]				
IRQ10		[Available]				
IRQ11		[Available]				
IRQ14		[Available]				
IRQ15		[Available]				
DMA Channel 0		[Available]				← Select Screen
DMA Channel 1		[Available]				↑↓ Select Item
DMA Channel 3		[Available]				+− Change Option
DMA Channel 5		[Available]				F1 General Help
DMA Channel 6		[Available]				F10 Save and Exit
DMA Channel 7		[Available]				ESC Exit
Reserved Memory Size		[Disabled]				
v02.61 (C) Copyright 1985-2006, American Megatrends, Inc.						

#### Clear NVRAM

Clear NVRAM during System BOOT.

The Choice: Yes, No.

## **Plug & Play O/S**

No: Lets the BIOS configure all the devices in the system.

Yes: lets the operating system configure Plug and Play (PnP) devices not required for BOOT if your system has a Plug and Play operating system.

## **PCI Latency Timer**

Value in units of PCI clocks for PCI device latency timer register.

## **Allocate IRQ to PCI VGA**

Yes: Assigns IRQ to PCI VGA card if card requests IRQ.

No: Does not assign IRQ to PCI VGA card even if card requests an IRQ.

## **PCI IDE BusMaster**

Enabled: BIOS uses PCI busMastering for reading / writing to IDE drives.

## **Spread Spectrum Function**

This item allows you to enable/disable the spread spectrum function.

The Choice: Enabled, Disabled.

## **IRQ3 - IRQ15**

Available: Specified IRQ is available to be used by PCI/PnP devices.

Reserved: Specified IRQ is reserved for use by Legacy ISA devices.

## **DMA Channel 0 - DMA Channel 7**

Available: Specified DMA is available to be used by PCI/PnP devices.

Reserved: Specified DMA is reserved for use by Legacy ISA devices.

## **Reserved Memory Size**

Size of memory block to reserve for legacy ISA devices.

### 3.4 Boot Settings



#### Boot Device Priority

Press Enter and it shows Bootable add-in devices.

#### Removable Drives

Press Enter and it shows Bootable and Removable drives.

## Boot Settings Configuration

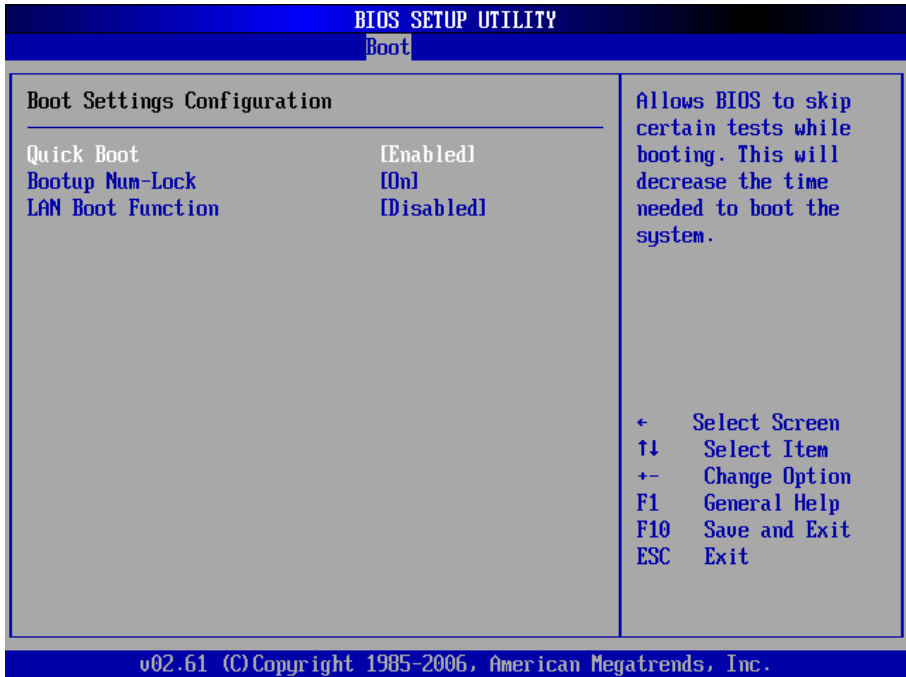

### Quick Boot

Allows BIOS to skip certain tests while booting. This will decrease the time needed to boot the system.

### Bootup Num-Lock

Set this value to allow the Number Lock setting to be modified during boot up.

### LAN Boot Function

Set this option to LAN add-on Boot ROM function.



### 3.5 Security

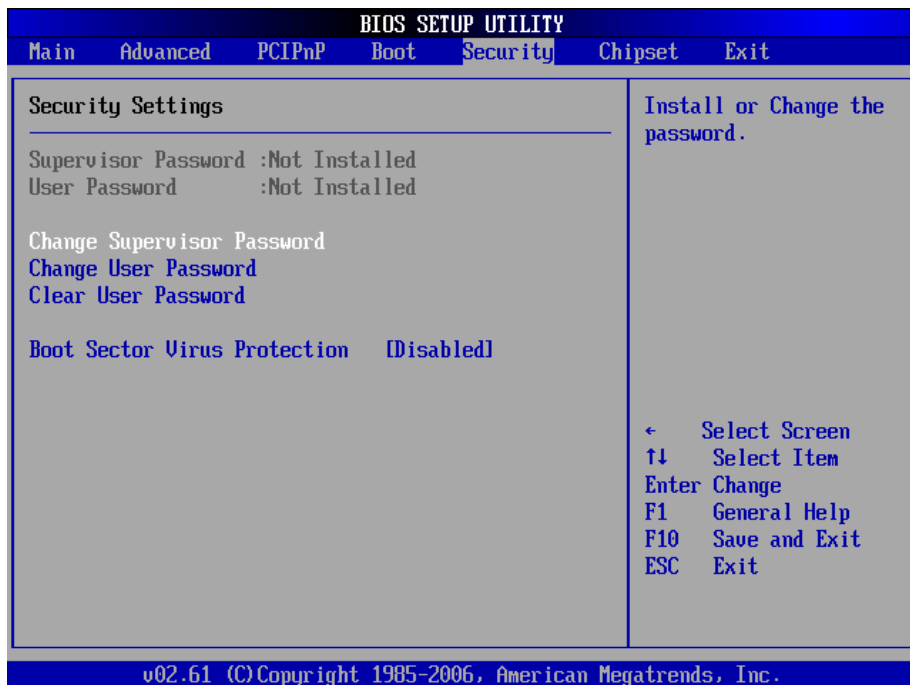

#### Supervisor Password & User Password

You can set either supervisor or user password, or both of them. The differences between are:

Set **Supervisor Password**: Can enter and change the options of the setup menus.

Set **User Password**: Just can only enter but do not have the right to change the options of the setup menus. When you select this function, the following message will appear at the center of the screen to assist you in creating a password.

ENTER PASSWORD:

Type the password, up to eight characters in length, and press <Enter>. The password typed now will clear any previously entered password from CMOS memory. You will be asked to confirm the password. Type the password again and press <Enter>. You may also press <ESC> to abort the selection and not enter a password.

To disable a password, just press <Enter> when you are prompted to enter the password. A message will confirm the password will be disabled. Once the password is disabled, the system will boot and you can enter Setup freely.

PASSWORD DISABLED.

When a password has been enabled, you will be prompted to enter it every time you try to enter Setup. This prevents an unauthorized person from changing any part of your system configuration.

Additionally, when a password is enabled, you can also require the BIOS to request a password every time your system is rebooted. This would prevent unauthorized use of your computer.

You determine when the password is required within the BIOS Features Setup Menu and its Security option. If the Security option is set to “System”, the password will be required both at boot and at entry to Setup. If set to “Setup”, prompting only occurs when trying to enter Setup.

### **Boot Sector Virus Protection**

Enable/Disable Boot Sector Virus Protection.

## 3.6 Advanced Chipset Settings

### North Bridge Chipset Configuration

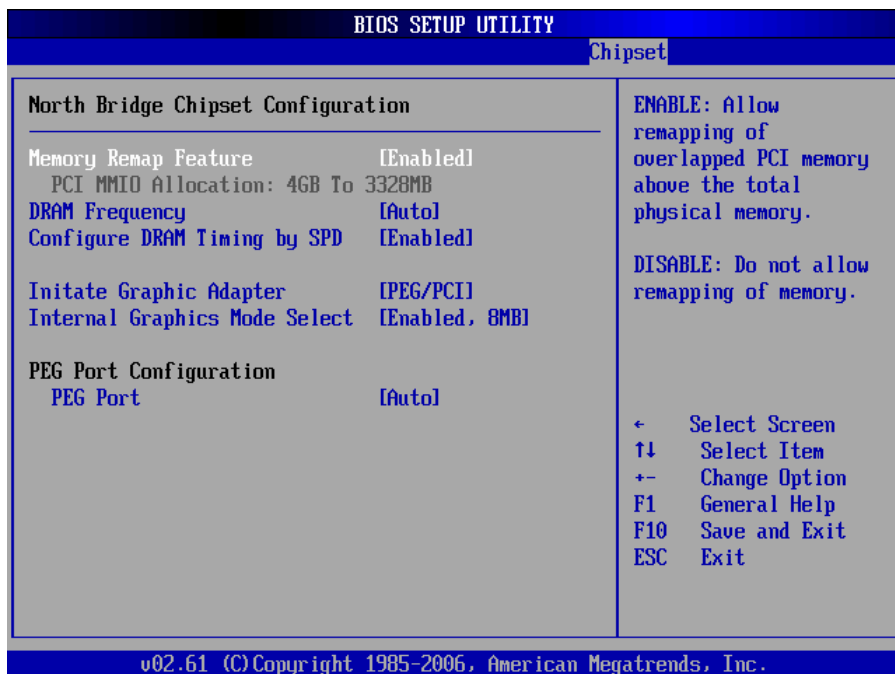

#### Memory Remap Feature

Enable: Allow remapping of overlapped PCI memory above the total physical memory.

Disable: Do not allow remapping of memory.

#### DRAM Frequency

The item allows you to set the DRAM frequency.

#### Configure DRAM Timing by SPD

Select the operating system that is selecting SRAM timing, so select SPD for setting SDRAM timing by SPD.

The Choice: Enable, Disable

### Initate Graphic Adapter

Select which graphics controller to use as the primary boot device.

### Internal Graphic Mode Select

Select the amount of system memory used by the Internal graphics device.

### PEG Port Configuration

This item allows you to control the PEG or on-chip VGA.

The Choice: Auto, Disabled.

### South Bridge Chipset Configuration

The screenshot shows the BIOS Setup Utility interface. At the top, it says "BIOS SETUP UTILITY" and "Chipset". The main area is titled "South Bridge Chipset Configuration" and contains the following settings:

USB Functions	[10 USB Ports]
USB 2.0 Controller	[Enabled]
HDA Controller	[Enabled]
Onboard Giga LAN 1	[Enabled]
Onboard Giga LAN 2	[Enabled]
SLP_S4# Min. Assertion Width	[1 to 2 seconds]

To the right of these settings is an "Options" menu with the following choices:

- Disabled
- 2 USB Ports
- 4 USB Ports
- 6 USB Ports
- 8 USB Ports
- 10 USB Ports

At the bottom right, there is a legend for navigation keys:

- ← Select Screen
- ↑↓ Select Item
- +/- Change Option
- F1 General Help
- F10 Save and Exit
- ESC Exit

At the very bottom of the screen, it says "v02.61 (C) Copyright 1985-2006, American Megatrends, Inc."

---

## USB Funtion

This item allows you to active USB ports.

The Choice:

- Disabled
- 2 USB Ports
- 4 USB Ports
- 6 USB Ports
- 8 USB Ports
- 10 USB Ports

## USB 2.0 Controller

Select “Enabled” if your system contains a Universal Serial Bus 2.0 (USB 2.0) controller and you have USB peripherals.

The Choice: Enabled, Disabled.

## HDA Controller

This item allows you to select the chipset family to support High Definition Audio Controller.

The Choice: Enabled, Disabled.

## Onboard Giga LAN1 / LAN2

Select “Enabled” if your system has a LAN device installed on the system board and you wish to use it.

The Choice: Enabled, Disabled.

## SLP\_S4# Min. Assertion Width

The item allows you to select the assertion width of SLP\_S4#.

The Choice:

- 4 to 5 Seconds.
- 3 to 4 Seconds.
- 2 to 3 Seconds.
- 1 to 2 Seconds.

### 3.7 Exit Options

#### Save Changes and Exit



Pressing <Enter> on this item asks for confirmation:

Save configuration changes and exit setup?

Pressing <OK> stores the selection made in the menus in CMOS - a special section of memory that stays on after you turn your system off. The next time you boot your computer, the BIOS configures your system according to the Setup selections stored in CMOS. After saving the values the system is restarted again.

## Discard Changes and Exit



Exit system setup without saving any changes.  
<ESC> key can be used for this operation.

## Discard Changes

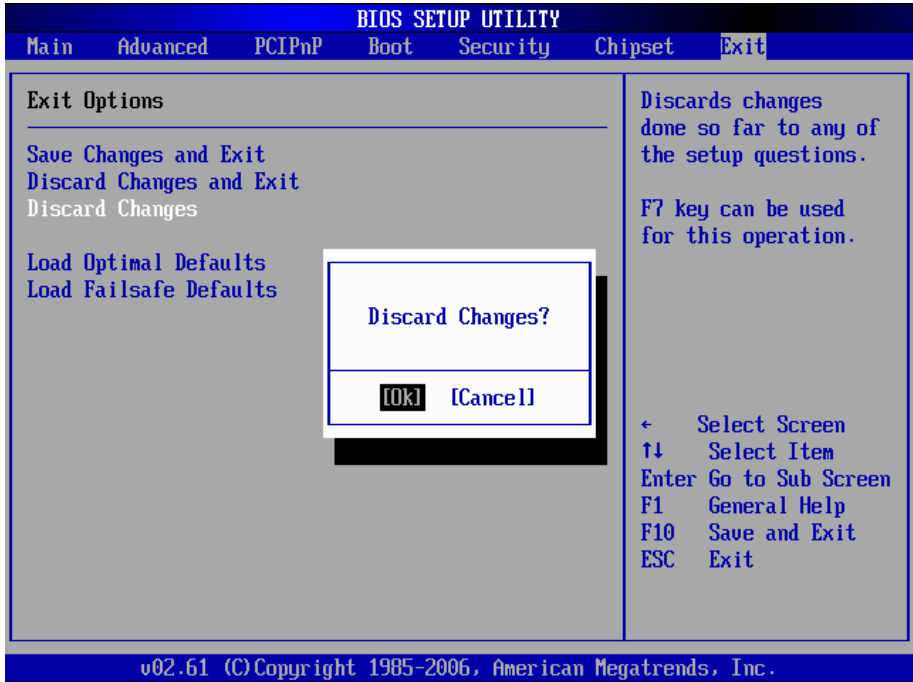

Discards changes done so far to any of the setup questions.  
<F7> can be used for this operation.



## Load Optimal Defaults



When you press <Enter> on this item you get a confirmation dialog box with a message:

Load Optimal Defaults?  
[OK]      [Cancel]

Pressing [OK] loads the BIOS Optimal Default values for all the setup questions.

<F9> key can be used for this operation.

## Load Failsafe Defaults



When you press <Enter> on this item you get a confirmation dialog box with a message:

Load Failsafe Defaults?  
[OK]    [Cancel]

Pressing [OK] loads the BIOS Failsafe Default values for all the setup questions.

<F8> key can be used for this operation.

### 3.8 Beep Sound codes list

#### Boot Block Beep codes

Number of Beeps	Description
1	Insert diskette in floppy drive A:
2	'AMIBOOT.ROM' file not found in root directory of diskette in A:
4	Flash Programming successful
5	Floppy read error
6	Keyboard controller BAT command failed
7	No Flash EPROM detected
8	Floppy controller failure
9	Boot Block BIOS checksum error
10	Flash Erase error
11	Flash Program error
12	'AMIBOOT.ROM' file size error
13	BIOS ROM image mismatch (file layout does not match image present in flash device)

#### POST BIOS Beep codes

Number of Beeps	Description
1	Memory refresh timer error.
2	Parity error in base memory (first 64KB block)
4	Motherboard timer not operational
5	Processor error
6	8042 Gate A20 test error (cannot switch to protected mode)
7	General exception error (processor exception interrupt error)
8	Display memory error (system video adapter)
9	AMIBIOS ROM checksum error
10	CMOS shutdown register read/write error
11	Cache memory test failed

## Troubleshooting POST BIOS Beep codes

Number of Beeps	Description
1, 2 or 3	<p>Reseat the memory, or replace with known good modules.</p>
4-7, 9-11	<p>Fatal error indicating a serious problem with the system. Consult your system manufacturer. Before declaring the motherboard beyond all hope, eliminate the possibility of interference by a malfunctioning add-in card. Remove all expansion cards except the video adapter.</p> <ul style="list-style-type: none"> <li>• If beep codes are generated when all other expansion cards are absent, consult your system manufacturer's technical support.</li> <li>• If beep codes are not generated when all other expansion cards are absent, one of the add-in cards is causing the malfunction. Insert the cards back into the system one at a time until the problem</li> </ul>
8	<p>If the system video adapter is an add-in card, replace or reset the video adapter. If the video adapter is an integrated part of the system board, the board may be faulty.</p>

## 3.9 AMI BIOS Checkpoints

### Bootblock Initialization Code Checkpoints

The Bootblock initialization code sets up the chipset, memory and other components before system memory is available. The following table describes the type of checkpoints that may occur during the bootblock initialization portion of the BIOS *(Note)*:

Checkpoint	Description
Before D0	If boot block debugger is enabled, CPU cache-as-RAM functionality is enabled at this point. Stack will be enabled from this point.
D0	Early Boot Strap Processo (BSP) initialization like microcode update, frequency and other CPU cirtical initialization. Early chipset initialization is done.
D1	Early super I/O initialization is done including RTC and keyboard controller. Serial port is enabled at this point if needed for debugging. NMI is deisabled. Perfrom keyboard controller BAT test. Save power-on CPUID value in scretch CMOS. Go to flat mode with 4GB limit and GA20 enabled.
D2	Verify the boot block checksum. System will hang here if checksum is bad.
D3	Disable CACHE before memory detection. Execute full memory sizing module. If memory sizing module not executed, start memory refresh and do memory sizing in Boot block code. Do additional chipset initialization. Re-enabled CACHE. Verify that flat mode is enabled.
D4	Test base 512KB memory. Adjust policies and cache first 8MB. Set stack.
D5	Bootblock code is copied from ROM to lower system memory and control is given to it. BIOS now executes out of RAM. Copies compressed boot block code to memory in right segments. Copies BIOS from ROM to RAM for faster access. Performs main BIOS checksum and updates recovery status accordingly.

---

D6	Both key sequence and OEM specific method is checked to determine if BIOS recovery is forced. If BIOS recovery is necessary, control flows to checkpoint E0. See <i>Bootblock Recovery Code Checkpoints</i> section of document for more information.
D7	Restore CPUID value back into register. The Bootblock- Runtime interface module is moved to system memory and control is given to it. Determine whether in memory.
D8	The Runtime module is uncompressed into memory. CPUID information is stored in memory.
D9	Store the Uncompressed pointer for future use in PMM. Copying Main BIOS into memory. Leaves all RAM below 1MB Read-Write including E000 and F000 shadow areas but closing SMRAM.
DA	Restore CPUID value back into register. Give control to BIOS POS (ExecutePOSTKernel). See <i>POST Code Checkpoints</i> section of document for more information.
DC	System is waking from ACPI S3 state.
E1 - E8 EC - EE	OEM memory detection / configuration error. This range is reserved for chipset vendors & system manufacturers. The error associated with this value may be different from one platform to be next.

---

## Bootblock Recovery Code Checkpoints

The Bootblock recovery code gets control when the BIOS determines that a BIOS recovery needs to occur because the user has forced the update or the BIOS checksum is corrupt. The following table describes the type of checkpoints that may occur during the Bootblock recovery portion of the BIOS *(Note)*:

Checkpoint	Description
E0	Initialize the floppy controller in the super I/O. Some interrupt vectors are initialized. DMA controller is initialized. 8259 interrupt controller is initialized. L2 cache is enabled.
E9	Set up floppy controller and data. Attempt to read from floppy.
EA	Enable ATAPI hardware. Attempt to read from ARMD and ATAPI CDROM.
EB	Disable ATAPI hardware. Jump back to checkpoint E9.
EF	Read error occurred on media. Jump back to checkpoint EB.
F0	Search for pre-defined recovery file name in root directory.
F1	Recovery file not found.
F2	Start reading FAT table and analyze FAT to find the clusters occupied by the recovery file.
F3	Start reading the recovery file cluster by cluster.
F5	Disable L1 cache.
FA	Check the validity of the recovery file configuration to the current configuration of the flash part.
FB	Make flash write enabled through chipset and OEM specific method. Detect proper flash part. Verify that the found flash part size equals the recovery file size.
F4	The recovery file size does not equal the found flash part size.

---

FC	Erase the flash part.
----	-----------------------

---

FD	Program the flash part.
----	-------------------------

---

FF	The flash has been updated successfully. Make flash write disabled. Disable ATAPI hardware. Restore CPUID value back into register. Give control to F000 ROM at F000:FFF0h.
----	---



## POST Code Checkpoints

The POST code checkpoints are the largest set of checkpoints during the BIOS pre-boot process. The following table describes the type of checkpoints that may occur during the POST portion of the BIOS <sup>(Note)</sup>:

Checkpoint	Description
03	Disable NMI, Parity, video for EGA, and DMA controllers. Initialize BIOS, POST, Runtime data area. Also initialize BIOS modules on POST entry and GPNV area. Initialize CMOS as mentioned in the Kernel Variable "wCMOSFlags."
04	Check CMOS diagnostic byte to determine if battery power is OK and CMOS checksum is OK. Verify CMOS checksum manually by reading storage area. If the CMOS checksum is bad, update CMOS with power-on default values and clear passwords. Initialize status register A. Initializes data variables that are based on CMOS setup questions. Initializes both the 8259 compatible PICs in the system.
05	Initializes the interrupt controlling hardware (generally PIC) and interrupt vector table.
06	Do R/W test to CH-2 count reg. Initialize CH-0 as system timer. Install the POSTINT1Ch handler. Enable IRQ-0 in PIC for system timer interrupt. Traps INT1Ch vector to "POSTINT1ChHandlerBlock."
07	Fixes CPU POST interface calling pointer.
08	Initializes the CPU. The BAT test is being done on KBC. Program the keyboard controller command byte is being done after Auto detection of KB/MS using AMI KB-5.
C0	Early CPU Init Start -- Disable Cache - Init Local APIC
C1	Set up boot strap processor Information
C2	Set up boot strap processor for POST
C5	Enumerate and set up application processors
C6	Re-enable cache for boot strap processor

C7	Early CPU Init Exit
0A	Initializes the 8042 compatible Key Board Controller.
0B	Detects the presence of PS/2 mouse.
0C	Detects the presence of Keyboard in KBC port.
0E	Testing and initialization of different Input Devices. Also, update the Kernel Variables. Traps the INT09h vector, so that the POST INT09h handler gets control for IRQ1. Uncompress all available language, BIOS logo, and Silent logo modules.
13	Early POST initialization of chipset registers.
20	Relocate System Management Interrupt vector for all CPU in the system.
24	Uncompress and initialize any platform specific BIOS modules. GPNV is initialized at this checkpoint.
2A	Initializes different devices through DIM. See DIM Code Checkpoints section of document for more information.
2C	Initializes different devices. Detects and initializes the video adapter installed in the system that have optional ROMs.
2E	Initializes all the output devices.
31	Allocate memory for ADM module and uncompress it. Give control to ADM module for initialization. Initialize language and font modules for ADM. Activate ADM module.
33	Initializes the silent boot module. Set the window for displaying text information.
37	Displaying sign-on message, CPU information, setup key message, and any OEM specific information.

---

38	Initializes different devices through DIM. See DIM Code Checkpoints section of document for more information. USB controllers are initialized at this point.
39	Initializes DMAC-1 & DMAC-2.
3A	Initialize RTC date/time.
3B	Test for total memory installed in the system. Also, Check for DEL keys to limit memory test. Display total memory in the system.
3C	Mid POST initialization of chipset registers.
40	Detect different devices (Parallel ports, serial ports, and coprocessor in CPU, ... etc.) successfully installed in the system and update the BDA, EBDA...etc.
52	Updates CMOS memory size from memory found in memory test. Allocates memory for Extended BIOS Data Area from base memory. Programming the memory hole or any kind of implementation that needs an adjustment in system RAM size if needed.
60	Initializes NUM-LOCK status and programs the KBD typematic rate.
75	Initialize Int-13 and prepare for IPL detection.
78	Initializes IPL devices controlled by BIOS and option ROMs.
7C	Generate and write contents of ESCD in NVRam.
84	Log errors encountered during POST.
85	Display errors to the user and gets the user response for error.
87	Execute BIOS setup if needed / requested. Check boot password if installed.
8C	Late POST initialization of chipset registers.
8D	Build ACPI tables (if ACPI is supported)
8E	Program the peripheral parameters. Enable/Disable NMI as selected.
90	Initialization of system management interrupt by invoking all handlers.
A1	Lian-up work needed before booting to OS.

---

---

A2	Takes care of runtime image preparation for different BIOS modules. Fill the free area in F000h segment with 0FFh. Initializes the Microsoft IRQ Routing Table. Prepares the runtime language module. Disables the system configuration display if needed.
A4	Initialize runtime language module. Display boot option popup menu.
A7	Displays the system configuration screen if enabled. Initialize the CPU's before boot, which includes the programming of the MTRR's.
A9	Wait for userinput at config display if needed.
AA	Uninstall POST INT1Ch vector and INT09h vector.
AB	Prepare BBS for Int 19 boot. Init MP tables.
AC	End of POST initialization of chipset registers. De-initializes the ADM module.
B1	Save system context for ACPI. Prepare CPU for OS boot including final MTRR values.
00	Passes control to OS Loader (typically INT19h).

---

## DIM Code Checkpoints

The Device Initialization Manager (DIM) gets control at various times during BIOS POST to initialize different system buses. The following table describes the main checkpoints where the DIM module is accessed *(Note)*:

Checkpoint	Description
2A	Initialize different buses and perform the following functions: Reset, Detect, and Disable (function 0); Static Device Initialization (function 1); Boot Output Device Initialization (function 2). Function 0 disables all device nodes, PCI devices, and PnP ISA cards. It also assigns PCI bus numbers. Function 1 initializes all static devices that include manual configured onboard peripherals, memory and I/O decode windows in PCI-PCI bridges, and noncompliant PCI devices. Static resources are also reserved. Function 2 searches for and initializes any PnP, PCI, or AGP video devices.
38	Initialize different buses and perform the following functions: Boot Input Device Initialization (function 3); IPL Device Initialization (function 4); General Device Initialization (function 5). Function 3 searches for and configures PCI input devices and detects if system has standard keyboard controller. Function 4 searches for and configures all PnP and PCI boot devices. Function 5 configures all onboard peripherals that are set to an automatic configuration and configures all remaining PnP and PCI devices.

While control is in the different functions, additional checkpoints are output to port 80h as a word value to identify the routines under execution. The low byte value indicates the main POST Code Checkpoint. The high byte is divided into two nibbles and contains two fields. The details of the high byte of these checkpoints are as follows:

### HIGH BYTE XY

The upper nibble "X" indicates the function number that is being executed. "X" can be from 0 to 7.

- 0 = func#0, disable all devices on the BUS concerned.
- 2 = func#2, output device initialization on the BUS concerned.
- 3 = func#3, input device initialization on the BUS concerned.
- 4 = func#4, IPL device initialization on the BUS concerned.
- 5 = func#5, general device initialization on the BUS concerned.
- 6 = func#6, error reporting for the BUS concerned.
- 7 = func#7, add-on ROM initialization for all BUSES.
- 8 = func#8, BBS ROM initialization for all BUSES.

The lower nibble 'Y' indicates the BUS on which the different routines are being executed. 'Y' can be from 0 to 5.

- 0 = Generic DIM (Device Initialization Manager).
- 1 = On-board System devices.
- 2 = ISA devices.
- 3 = EISA devices.
- 4 = ISA PnP devices.
- 5 = PCI devices.

## ACPI Runtime Checkpoints

ACPI checkpoints are displayed when an ACPI capable operating system either enters or leaves a sleep state. The following table describes the type of checkpoints that may occur during ACPI sleep or wake events <sup>(Note)</sup>:

Checkpoint	Description
AC	First ASL check point. Indicates the system is running in ACPI mode.
AA	System is running in APIC mode.
01, 02, 03, 04, 05	Entering sleep state S1, S2, S3, S4, or S5.
10, 20, 30, 40, 50	Waking from sleep state S1, S2, S3, S4, or S5.

**Note:**

*Please note that checkpoints may differ between different platforms based on system configuration. Checkpoints may change due to vendor requirements, system chipset or option ROMs from add-in PCI devices.*

This page is intentionally left blank.





# Chapter 4

# Appendix

## 4.1 I/O Port Address Map

Each peripheral device in the system is assigned a set of I/O port addresses which also becomes the identity of the device.

The following table lists the I/O port addresses used.

Address	Device Description
00000000 - 0000000F	DMA Controller
00000080 - 0000009F	DMA Controller
000000C0 - 000000DF	DMA Controller
00000020 - 00000021	Programmable Interrupt Controller
000000A0 - 000000A1	Programmable Interrupt Controller
00000040 - 00000043	System Timer
00000044 - 00000047	System Timer
00000060 - 00000064	Keyboard Controller
00000070 - 00000073	System CMOS/Real Time Clock
000000F0 - 000000FF	Math Co-processor
00000274 - 00000277	ISAPNP Read Data Port
00000279 - 00000279	ISAPNP Configuration
000002F8 - 000002FF	Communications Port (COM2, If use)
00000378 - 0000037A	Parallel Port (If use)
000003B0 - 000003BF	MDA/MGA
000003C0 - 000003CF	EGA/VGA
000003D4 - 000003D9	CGA CRT register
000003F0 - 000003F7	Floppy Diskette
000003F8 - 000003FF	Communications Port (COM1, If use)
00000400 - 0000041F	South Bridge SMB
00000480 - 000004BF	South Bridge GPIO
000004D0 - 000004D1	IRQ Edge/Level Control Ports
00000800 - 0000087F	ACPI
00000A00 - 00000A07	PME
00000A10 - 00000A17	Hardware Monitor
00000A20 - 00000A27	Digital I/O

00000A30 - 00000A37	SFIF
00000CF8	PCI Configuration Address
00000CFC	PCI Configuration Data
00004700 - 0000470B	TPM (If use)

## 4.2 Interrupt Request Lines (IRQ)

Peripheral devices use interrupt request lines to notify CPU for the service required. The following table shows the IRQ used by the devices on board.

Level	Function
IRQ 0	System Timer
IRQ 1	Keyboard Controller
IRQ 2	VGA and Link to Secondary PIC
IRQ 3	Communications Port (COM2)
IRQ 4	Communications Port (COM1)
IRQ 5	PCI Device
IRQ 6	Standard Floppy Disk Controller
IRQ 7	Parallel Port
IRQ 8	System CMOS/real time clock
IRQ 9	Microsoft ACPI-Compliant System
IRQ 10	PCI Device
IRQ 11	PCI Device
IRQ 12	PS/2 Compatible Mouse
IRQ 13	FPU Exception
IRQ 14	PCI Device
IRQ 15	PCI Device

### 4.3 BIOS memory mapping

Address	Device Description
00000h - 9FFFFh	DOS Kernel Area
A0000h, BFFFFh	EGA and VGA Video Buffer (128KB)
C00000h - CFFFFh	EGA/VGA ROM
D0000h - DFFFFh	Adaptor ROM
E00000h - FFFFFh	System BIOS
EFD40000h - FED44FFFFh	TPM (If use)