

PC-HELPER

10MSPS 12-bit
Analog Input Board for PCI

AI-1204Z-PCI

User's Guide

CONTEC CO., LTD.

Check Your Package

Thank you for purchasing the CONTEC product.

The product consists of the items listed below.

Check, with the following list, that your package is complete. If you discover damaged or missing items, contact your retailer.

Product Configuration List

- Board [AI-1204Z-PCI] ...1
- First step guide ...1
- CD-ROM *1 [API-PAC(W32)] ...1
- Synchronization control cable (10cm) ...1

*1 The CD-ROM contains the driver software and User's Guide (this guide)

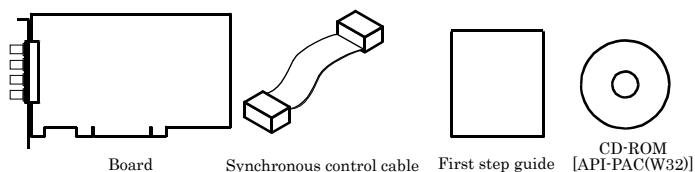

Copyright

Copyright 2007 CONTEC CO., LTD. ALL RIGHTS RESERVED

No part of this document may be copied or reproduced in any form by any means without prior written consent of CONTEC CO., LTD.

CONTEC CO., LTD. makes no commitment to update or keep current the information contained in this document. The information in this document is subject to change without notice.

All relevant issues have been considered in the preparation of this document. Should you notice an omission or any questionable item in this document, please feel free to notify CONTEC CO., LTD.

Regardless of the foregoing statement, CONTEC assumes no responsibility for any errors that may appear in this document or for results obtained by the user as a result of using this product.

Trademarks

MS, Microsoft, Windows and Windows NT are trademarks of Microsoft Corporation. Other brand and product names are trademarks of their respective holder.

Table of Contents

Check Your Package	i
Copyright	ii
Trademarks	ii
Table of Contents	iii

1. BEFORE USING THE PRODUCT	1
------------------------------------	----------

About the Board	1
Features	1
Support Software.....	3
Cable & Connector (Option).....	3
Accessories (Option)	3
Customer Support.....	4
Web Site.....	4
Limited Three-Years Warranty	4
How to Obtain Service.....	4
Liability	4
Safety Precautions	5
Safety Information	5
Handling Precautions.....	6
Environment	7
Inspection.....	7
Storage	7
Disposal	7

2. SETUP	9
-----------------	----------

What is Setup?.....	9
Using the Board under Windows Using the Driver Library API-PAC(W32).....	9
Using the Board under Windows Using Software Other than the Driver Library API-PAC(W32)	9
Using the Board under an OS Other than Windows	10
Step 1 Installing the Software	11
About the Driver	11
Starting the Install Program	12
Step 2 Setting the Hardware.....	14
Parts of the Board and Factory Defaults	14
Setting the Board ID	15
Switch Setting for Termination Resistor.....	15
Plugging the Board	16
Step 3 Installing the Hardware	17
Turning on the PC.....	17

When Using the API-AIO(WDM).....	17
Step 4 Initializing the Software.....	19
Step 5 Checking Operations with the Diagnosis Program.....	21
What is the Diagnosis Program?	21
Check Method	21
Using the Diagnosis Program for Use of API-AIO(WDM).....	22
Setup Troubleshooting.....	25
Symptoms and Actions.....	25
If your problem cannot be resolved.....	25

3.	EXTERNAL CONNECTION	27
-----------	----------------------------	-----------

How to connect the connectors	27
Connector shape.....	27
Connector Pin Assignment.....	28
Analog Input Signal Connection.....	30
Single-ended Input.....	30
Digital I/O signals and Control signals Connection.....	31
Synchronization Control Connectors	32
SC Connectors.....	32
Connecting the SC Connectors (CN3, CN4)	33

4.	FUNCTIONS	35
-----------	------------------	-----------

Analog Input Function	35
1. Setting the Conversion Conditions	36
2. Starting/Stopping Operation	45
3. Monitoring the Status and Acquiring Data.....	46
4.Reset.....	50
Digital Input Function.....	51
Digital Output Function.....	52
Event Controller Function	53

5.	ABOUT SOFTWARE	55
-----------	-----------------------	-----------

CD-ROM Directory Structure.....	55
About Software for Windows	56
Accessing the Help File.....	56
Using Sample Programs.....	57
Usage of Utility Program	59
Uninstalling the Driver Libraries	62

6.	ABOUT HARDWARE	65
-----------	-----------------------	-----------

Hardware specification	65
------------------------------	----

Block Diagram.....	67
Timing of Sampling Control Signals.....	68
Control Signal Timings for Analog Input.....	68
About Calibration.....	70



1. Before Using the Product

About the Board

This product is a PCI bus-compliant interface board that expands the input function of a PC for analog signals.

Maximum conversion speed is 10MSPS (100nsec), with simultaneous sampling of four channels at a same time. The large (32M data) buffer memory and bus master transfer function allow continuous data acquisition to be performed at high speed for a long period.

Sampling can be started and stopped by software, conversion data comparison (level comparison, in-range comparison, out-of-range comparison), external trigger, or event controller output.

Uses a BNC connector that can connect directly to the signal source.

Also features four digital input and output ports respectively (requires the optional DT-E3 cable).

You can use the driver library (API-PAC(W32)) supplied with the board to write Windows application programs in any programming language (such as Visual Basic, Visual C++, etc.) that supports the calling of Win32 API functions.

Features

- Maximum conversion speed is 10MSPS (100nsec), with simultaneous sampling of 4channels at a time

The maximum conversion speed is 10MSPS (100nsec) and 4channels can be sampled simultaneously. The range for each channel can be set independently by software to match the level of the input signal source.

(Input range : $\pm 10V$, $\pm 5V$, $\pm 2.5V$, $\pm 1.25V$ or $0 - +10V$, $0 - +5V$, $0 - +2.5V$)

Also features digital inputs and outputs (four LVTTTL level input and output ports respectively). (requires the optional DT-E3 cable)

- Sampling can be controlled by software, conversion data comparison, external trigger, event controller output, and similar start and stop conditions

Sampling can be setup to be started and stopped by software, conversion data comparison, external trigger, or event controller output.

Control of sampling start and stop is completely independent and a separate setting is provided for each. It is also possible to specify that sampling stop after a specified number of samples.

The conversion data comparison function can perform level, in-range, and out-of-range comparisons on the conversion data.

- Incorporates a synchronization control connector for synchronized operation

A synchronization control connector is provided for synchronized control of up to 16 boards. This means the number of channels can be increased simply by adding boards. It is also easy to synchronize operation with other CONTEC boards that have a synchronization control connector.

- Large (32M data) buffer memory and bus master transfer function allow continuous data acquisition at high speed for a long period.

The large (32M data) buffer memory and bus master transfer function allow continuous data acquisition to be performed at high speed for a long period. The bus master transfer function allows large volumes of data to be transferred between the board and PC without loading the CPU.

- BNC connector used for analog input pin

The BNC connector used for the analog input has a characteristic impedance of 50Ω and is of a type commonly used for high speed analog signal.

This makes it easy to connect to other devices with a BNC connector.

- Termination resistor selection function

A 50Ω termination resistor can be set to minimize the distortion caused by the reflection of high-speed input signals. The input range cannot be set to $\pm 10V$ or 0 to $+10V$ when the termination resistor is used.

- Digital filter function included to prevent misdetection due to chattering on external input signals

A digital filter is included to prevent misdetection due to chattering on the digital input signals.

- Software-based calibration function

Calibration of analog input can be all performed by software. Apart from the adjustment information prepared before shipment, additional adjustment information can be stored according to the use environment.

- Windows compatible driver libraries are attached.

Using the attached driver library API-PAC(W32) makes it possible to create applications of Window.

In addition, a diagnostic program by which the operations of hardware can be checked is provided.

Support Software

You should use CONTEC support software according to your purpose and development environment.

Windows version of analog I/O driver **API-AIO(WDM)**
 [Stored on the bundled CD-ROM driver library API-PAC(W32)]

The API-AIO(WDM) is the Windows version driver library software that provides products in the form of Win32 API functions (DLL). Various sample programs such as Visual Basic and Visual C++, etc and diagnostic program

*Useful for checking operation is provided.

For more details on the supported OS, applicable language and new information, please visit the CONTEC's Web site.

Cable & Connector (Option)

< For analog I/O >

BNC Cable : BNC-B100 (1m)
 : BNC-B200 (2m)
 : BNC-B300 (3m)

< For digital I/O >

Conversion Cable (16-Pin to 15-Pin) with Bracket (150mm) : DT-E3
 Flat Cable with 1 Sided 16-Pin Header Connector (1.5m) : DT/E1
 Flat Cable with 15-Pin D-SUB Connector at One End : PCA15P-1.5 (1.5m) *1
 Flat Cable with 15-Pin D-SUB Connectors at either Ends : PCB15P-1.5 (1.5m) *1*2
 Shielded Cable with Connector on both sides for 15-pin D-Type Connector
 : PCB15PS-0.5P (0.5m) *1*2
 Shielded Cable with Connector on both sides for 15-pin D-Type Connector
 : PCB15PS-1.5P (1.5m) *1*2

*1 DT-E3 is required.

*2 It is required only when FTP-15 is used.

Accessories (Option)

General Purpose Terminal (M3 x 15P) : FTP-15 *1

*1 DT-E3 and PCB15P-1.5 optional cable is required separately.

* Check the CONTEC's Web site for more information on these options.

Customer Support

CONTEC provides the following support services for you to use CONTEC products more efficiently and comfortably.

Web Site

<https://www.contec.com/>

Latest product information

CONTEC provides up-to-date information on products.

CONTEC also provides product manuals and various technical documents in the PDF.

Free download

You can download updated driver software and differential files as well as sample programs available in several languages.

Note! For product information

Contact your retailer if you have any technical question about a CONTEC product or need its price, delivery time, or estimate information.

Limited Three-Years Warranty

CONTEC products are warranted by CONTEC CO., LTD. to be free from defects in material and workmanship for up to three years from the date of purchase by the original purchaser.

Repair will be free of charge only when this device is returned freight prepaid with a copy of the original invoice and a Return Merchandise Authorization to the distributor or the CONTEC group office, from which it was purchased.

This warranty is not applicable for scratches or normal wear, but only for the electronic circuitry and original products. The warranty is not applicable if the device has been tampered with or damaged through abuse, mistreatment, neglect, or unreasonable use, or if the original invoice is not included, in which case repairs will be considered beyond the warranty policy.

How to Obtain Service

For replacement or repair, return the device freight prepaid, with a copy of the original invoice. Please obtain a Return Merchandise Authorization number (RMA) from the CONTEC group office where you purchased before returning any product.

* No product will be accepted by CONTEC group without the RMA number.

Liability

The obligation of the warrantor is solely to repair or replace the product. In no event will the warrantor be liable for any incidental or consequential damages due to such defect or consequences that arise from inexperienced usage, misuse, or malfunction of this device.

Safety Precautions

Understand the following definitions and precautions to use the product safely.

Safety Information

This document provides safety information using the following symbols to prevent accidents resulting in injury or death and the destruction of equipment and resources. Understand the meanings of these labels to operate the equipment safely.

⚠ DANGER	DANGER indicates an imminently hazardous situation which, if not avoided, will result in death or serious injury.
⚠ WARNING	WARNING indicates a potentially hazardous situation which, if not avoided, could result in death or serious injury.
⚠ CAUTION	CAUTION indicates a potentially hazardous situation which, if not avoided, may result in minor or moderate injury or in property damage.

Handling Precautions

DANGER

Do not use the product where it is exposed to flammable or corrosive gas. Doing so may result in an explosion, fire, electric shock, or failure.

CAUTION

- There are switches and jumpers on this product that need to be set in advance. Be sure to check these before installing this product.
 - Only set the switches and jumpers on this product to the specified settings. Otherwise, this product may malfunction, overheat, or cause a failure.
 - Do not strike or bend this product. Otherwise, this product may malfunction, overheat, cause a failure or breakage.
 - Do not touch this product's metal plated terminals (edge connector) with your hands. Otherwise, this product may malfunction, overheat, or cause a failure. If the terminals are touched by someone's hands, clean the terminals with industrial alcohol.
 - As this product contains components that are designed to operate at high temperature, please do not touch this product when it is in use. The 50Ω termination resistor in particular can become hot if it is used.
 - Do not install this product to the expansion slot and do not plug or unplug the cables which are connected to this product while the PC or expansion unit is still turned on. Otherwise, this product may malfunction, overheat, or cause a failure. Be sure that the personal computer power is turned off.
 - Do not touch the external connector (BNC connector) when the power is on. Otherwise this may malfunction, cause a failure due to static electricity.
 - Make sure that your PC or expansion unit can supply ample power to all the products installed. Insufficiently energized products could malfunction, overheat, or cause a failure.
 - The specifications of this product are subject to change without notice for enhancement and quality improvement. Even when using the product continuously, be sure to read the manual and understand the contents.
 - Do not modify the product. CONTEC will bear no responsibility for any problems, etc., resulting from modifying this product.
 - Regardless of the foregoing statements, CONTEC is not liable for any damages whatsoever (including damages for loss of business profits) arising out of the use or inability to use this CONTEC product or the information contained herein.
 - Regarding "CE EMC Directive Notice". Please connect the Interface Connector with a shielded cable to meet the mentioned standard above.
-

Environment

Use this product in the following environment. If used in an unauthorized environment, the product may overheat, malfunction, or cause a failure.

Operating temperature

0 - 50°C

Operating humidity

10 - 90%RH (No condensation)

Corrosive gases

None

Floating dust particles

Not to be excessive

Inspection

Inspect the product periodically as follows to use it safely.

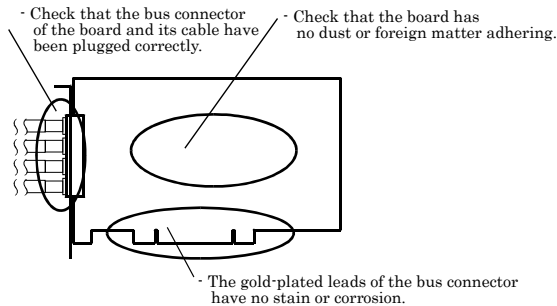

Storage

When storing this product, keep it in its original packing form.

- (1) Put this product in the storage bag.
- (2) Wrap it in the packing material, then put it in the box.
- (3) Store the package at room temperature at a place free from direct sunlight, moisture, shock, vibration, magnetism, and static electricity.

Disposal

When disposing of the product, follow the disposal procedures stipulated under the relevant laws and municipal ordinances.

2. Setup

This chapter explains how to set up the board.

What is Setup?

Setup means a series of steps to take before the product can be used.

Different steps are required for software and hardware.

The setup procedure varies with the OS and applications used.

Using the Board under Windows

Using the Driver Library API-PAC(W32)

This section describes the setup procedure to be performed before you can start developing application programs for the board using the bundled CD-ROM “Driver Library API-PAC(W32)”.

Taking the following steps sets up the software and hardware. You can use the diagnosis program later to check whether the software and hardware function normally.

Step 1 Installing the Software

Step 2 Setting the Hardware

Step 3 Installing the Hardware

Step 4 Initializing the Software

Step 5 Checking Operations with the Diagnosis Program

If Setup fails to be performed normally, see the “Setup Troubleshooting” section at the end of this chapter.

Using the Board under Windows

Using Software Other than the Driver Library API-PAC(W32)

For setting up software other than API-PAC(W32), refer to the manual for that software. See also the following parts of this manual as required.

This chapter Step 2 Setting the Hardware

This chapter Step 3 Installing the Hardware

Chapter 3 External Connection

Chapter 6 About Hardware

Using the Board under an OS Other than Windows

For using the board under Linux, see the following parts of this manual.

This chapter Step 2 Setting the Hardware

Chapter 3 External Connection

Chapter 6 About Hardware

Step 1 Installing the Software

This section describes how to install the API function libraries.

Before installing the hardware on your PC, install the Driver libraries from the bundled API-PAC(W32) CD-ROM.

The following description assumes the operating system as Windows XP. Although some user interfaces are different depending on the OS used, the basic procedure is the same.

About the Driver

There are the two drivers "API-AIO(WDM)" and "API-AIO(98/PC)" among the analog input/output drivers.

API-AIO(WDM) is a new driver to perform analog input and output under Windows.

It was developed aiming at "more easily use and more convenient" "more high performance" corresponding to the product version of API-AIO(98/PC) so far.

Please use the API-AIO(WDM) with this board. API-AIO(98/PC) is not supported.

Starting the Install Program

- (1) Load the CD-ROM [API-PAC(W32)] on your PC.
- (2) The API-PAC(W32) Installer window appears automatically.
If the panel does not appear, run (CD-ROM drive letter):\AUTORUN.exe.
- (3) Click on the [Install Development or Execution Environment] button.

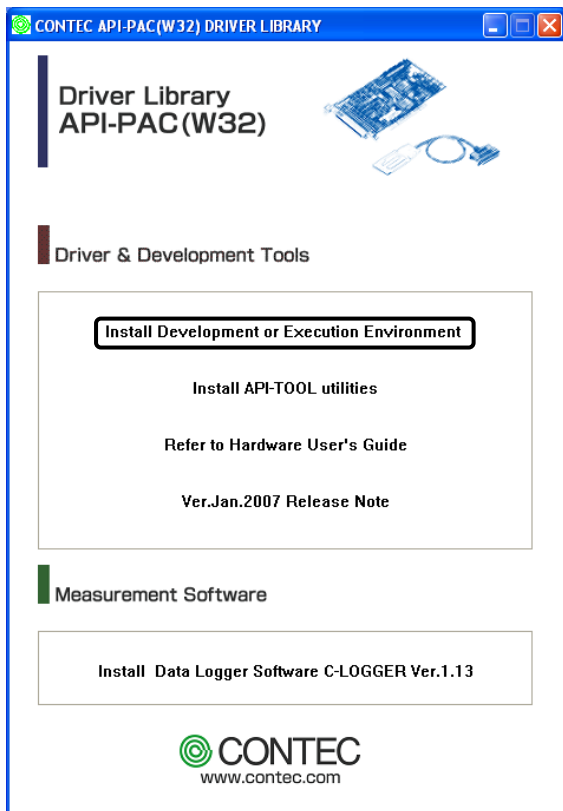

CAUTION

Before installing the software in Windows 7, Vista, XP, Server 2003, or 2000, log in as a user with administrator privileges.

Select API-AIO(WDM)

- (1) The following dialog box appears to select “Driver to install” and “Install option”, “Usage of driver library”.
- (2) Select the "High Functionality WDM Analog I/O driver".
- (3) Click on the [Install] button.

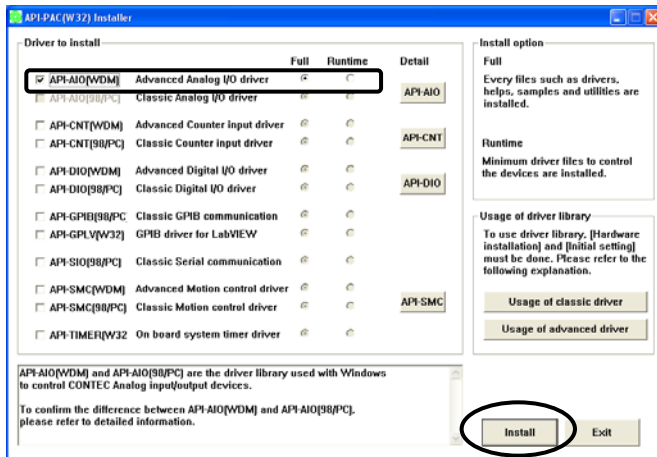

- * Clicking on the [API-AIO] button under the “Detail” displays detailed information about API-AIO(WDM) and API-AIO(98/PC).

Run the installation

- (1) Complete the installation by following the instructions on the screen.
- (2) The Readme file appears when the installation is complete.

You have now finished installing the software.

Step 2 Setting the Hardware

This section describes how to set this product and plug it on your PC.

This product has some switches to be preset.

Check the on-board switches before plugging this product into an expansion slot.

This product can be set up even with the factory defaults untouched. You can change board settings later.

Parts of the Board and Factory Defaults

Figure 2.1. shows the names of major parts on the board.

Note that the switches and jumpers setting shown below is the factory default.

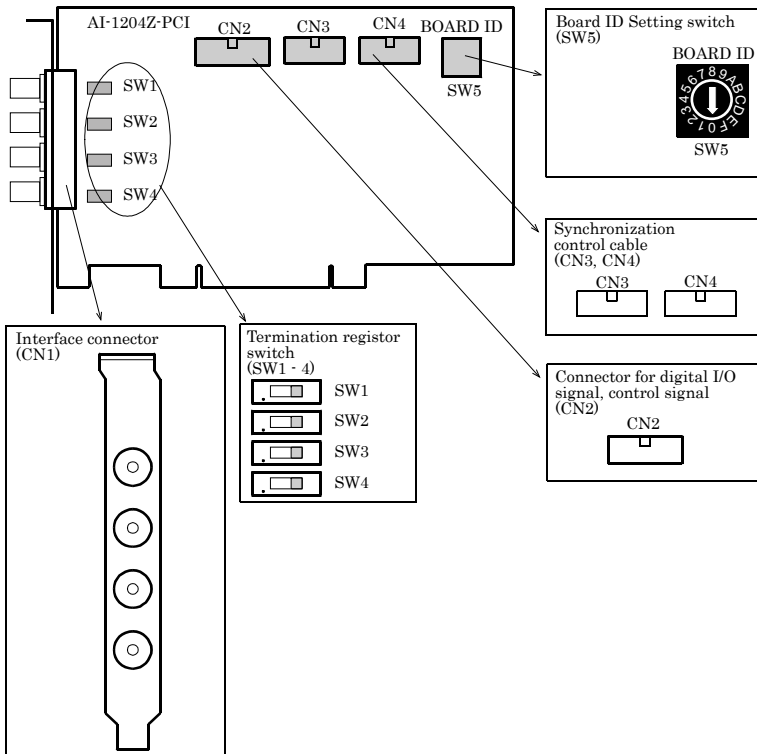

Figure 2.1. Part Names

Setting the Board ID

If you install two or more boards on one personal computer, assign a different ID value to each of the boards to distinguish them.

The board IDs can be set from 0 - Fh to identify up to sixteen boards.

If only one board is used, the original factory setting (Board ID = 0) should be used.

Setting Procedure

To set the board ID, use the rotary switch on the board. Turn the SW5 knob to set the board ID as shown below.

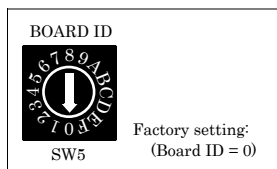

Figure 2.2. Board ID Settings (SW5)

Switch Setting for Termination Resistor

The termination resistor setting switch is used to insert the termination resistor.

Set up the termination resistor if suitable for the device to which you are connecting.

This product has internal 50Ω (±1%) termination resistors.

SW4 sets the resistor for channel 0, SW3 for channel 1, SW2 for channel 2, and SW1 for channel 3.

⚠ CAUTION

- Do not change the switch setting while the signal source is connected.
Changing the setting may damage this product or connected signal source.
- The input current increases when the 50Ω termination resistor is inserted.
Check the output current of the input signal source if connecting the termination resistor.
Inappropriate use of the termination resistor may damage the input signal source.

Termination resistor setting

If you want to set a termination resistor, set the switch corresponding to the desired channel to the connector side.

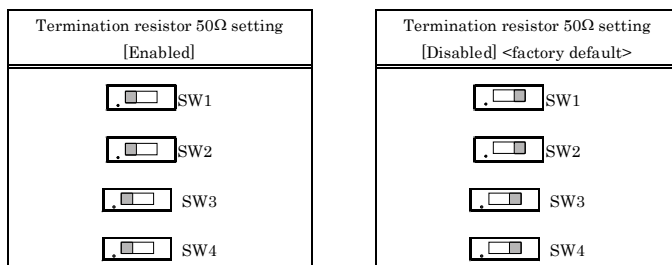

Figure 2.3. Termination resistor setting

Plugging the Board

- (1) Before plugging the board, shut down the system, unplug the power cord of your PC.
- (2) Remove the cover from the PC so that the board can be mounted.
- (3) Plug the board into an expansion slot.
- (4) Attach the board bracket to the PC with a screw.
- (5) Put the cover back into place.



Applicable PCI bus slots

PCI bus slots used in PCs have keys to prevent 5V and 3.3V PCI bus boards from being accidentally plugged into wrong bus slots. This board can be plugged into both of the 5V and 3.3V PCI bus slots.

<PCI bus slot>

5-V PCI bus slot

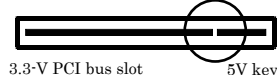

3.3-V PCI bus slot

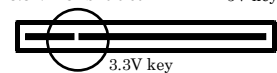

<PCI bus board>

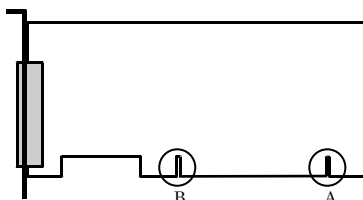

A : Slit for 5-V PCI bus slot
B : Slit for 3.3-V PCI bus slot

⚠ CAUTION

- Do not touch the board's metal plated terminals (edge connector) with your hands. Otherwise, the board may malfunction, overheat, or cause a failure. If the terminals are touched by someone's hands, clean the terminals with industrial alcohol.
- Do not install or remove the board to or from the slot while the computer's power is turned on. Otherwise, the board may malfunction, overheat, or cause a failure. Doing so could cause trouble. Be sure that the personal computer or the I/O expansion unit power is turned off.
- Make sure that your PC or expansion unit can supply ample power to all the boards installed. Insufficiently energized boards could malfunction, overheat, or cause a failure.
- Power supply from the PCI bus slot at +5V is required.

Step 3 Installing the Hardware

For using an expansion board under Windows, you have to let the OS detect the I/O addresses and IRQ to be used by the board. The process is referred to as installing the hardware.

Turning on the PC

Turn on the power to your PC.

⚠ CAUTION

- The board cannot be properly installed unless the resources (I/O addresses and interrupt level) for the board can be allocated. Before attempting to install the board, first determine what PC resources are free to use.
- The resources used by each board do not depend on the location of the PCI bus slot or the board itself. If you remove two or more boards that have already been installed and then remount one of them on the computer, it is unknown that which one of the sets of resources previously assigned to the two boards is assigned to the remounted board. In this case, you must check the resource settings.

When Using the API-AIO(WDM)

- (1) When the "Found New Hardware Wizard" opens, select "Install the software automatically [Recommended]" and then click the "Next" button.
- * The wizard may not appear for some OS versions and instead the installation will start automatically. In this case, proceed to the software initial setup step.



< If using Windows 98 or Windows Me >

If using Windows 98 or Windows Me, specify the folder that contains the setup information (INF) file from the CD-ROM.

Source folder

The setup information (INF) file is contained in the following folder on the bundled CD-ROM.

\INF\WDM\AIO

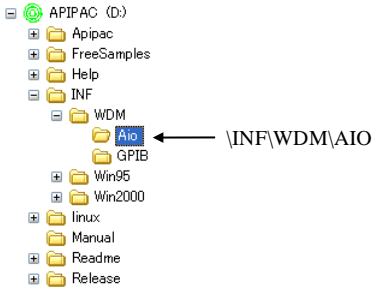

You have now finished installing the software.

Step 4 Initializing the Software

The driver library requires initial settings to determine the execution environment. This is called driver library initialization.

Setting the device name

- (1) Run Device Manager. From [My Computer] - [Control Panel], select [System] and then select the [Device Manager] tab.

(You can also open Device Manager by right clicking on My Computer and selecting Properties.)

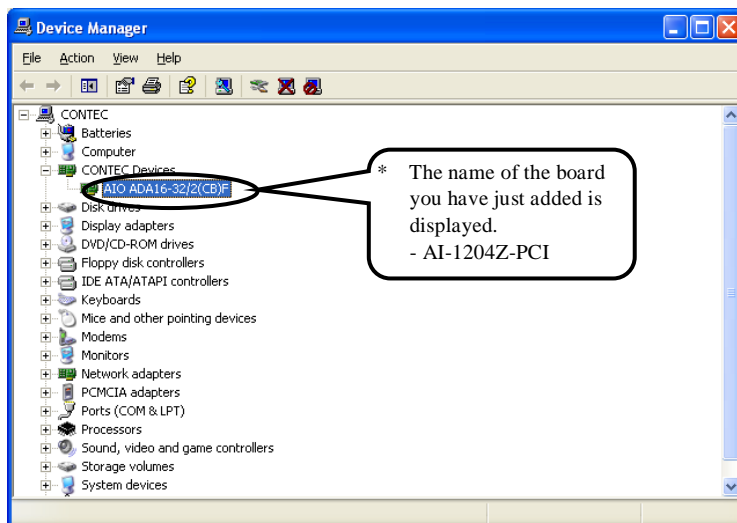

- (2) The installed hardware appears under the CONTEC Devices node. Open the CONTEC Devices node and select the device you want to setup (the device name should appear highlighted). Click [Properties].

(3) The property page for the device opens.

Enter the device name in the common settings tab page and then click [OK].

The device name you set here is used later when programming.

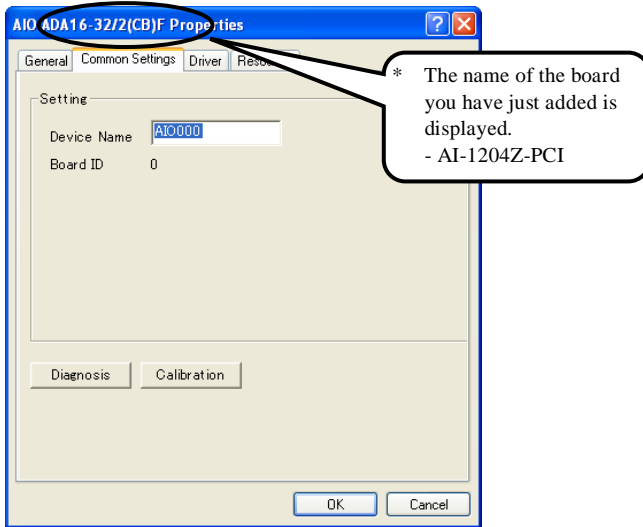

- * The initial device name that appears is a default value. You can use this default name if you wish.
- * Make sure that you do not use the same name for more than one device.

You have now finished installing the initial setting of Software.

Step 5 Checking Operations with the Diagnosis Program

Use the diagnosis program to check that the board and driver software work normally, thereby you can confirm that they have been set up correctly.

What is the Diagnosis Program?

The diagnosis program diagnoses the states of the board and driver software.

It can also be used as a simple checker when an external device is actually connected.

Using the “Diagnosis Report” feature reports the driver settings, the presence or absence of the board, I/O status, and interrupt status.

Check Method

Connect an external signal source to check the analog input data.

The diagrams below show examples of using channel 0 on the AI-1204Z-PCI. For details on the connections, see Chapter 3 “External Connection”.

< Analog input >

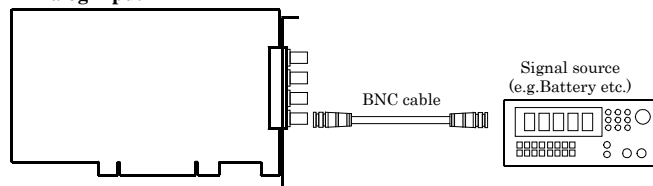

⚠ CAUTION

Input data remains indeterminate when no input pin is connected. The input pin for the channel not connected to the signal source must be connected to the analog ground. For details, see Chapter 3 “External Connection”.

Using the Diagnosis Program for Use of API-AIO(WDM)

Starting the Diagnosis Program

Click the [Diagnosis] button on the device property page to start the diagnosis program.

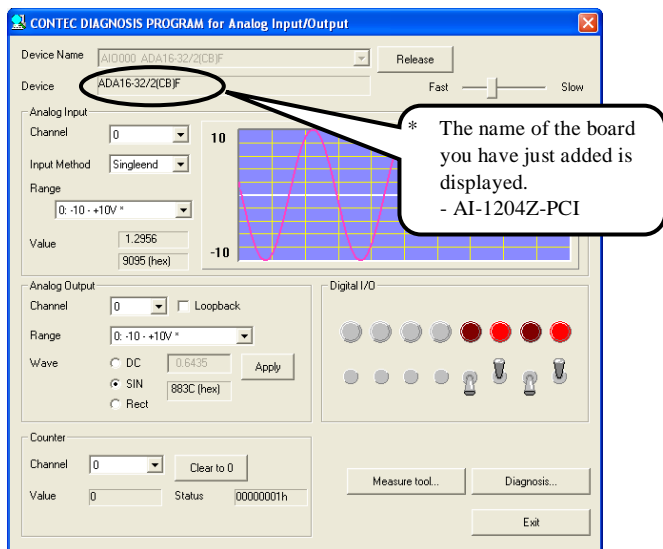
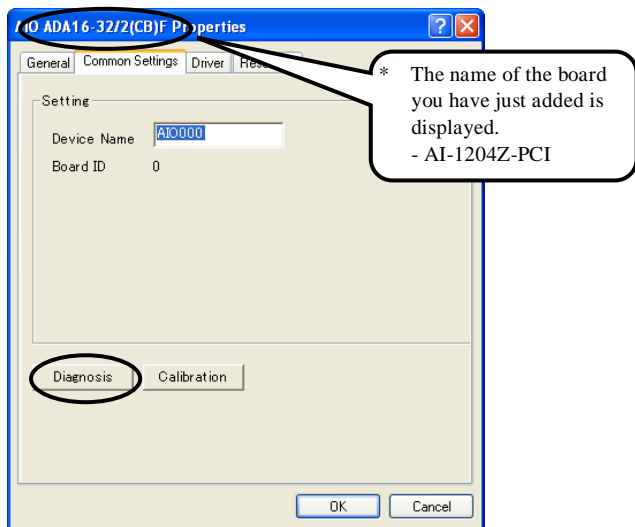

Analog input

You can select the desired input channel and input range from the lists.

Input data is plotted on a graph.

Digital input / output

The upper row of circular lamps indicates the digital input states. Red indicates the bit is ON and brown indicates OFF.

Clicking the lower row of switches turns the digital output bits ON or OFF.

Diagnosis Report

- (1) The diagnosis report saves detailed data, including the device settings and settings for each channel, to a text file and displays the file for you to view.

Clicking [Diagnosis Report] prompts you to specify where to save the report text file.

```

CAIORep.txt - Notepad
File Edit Format View Help
-----
CONTEC Analog I/O diagnostic report
-----
** CAIOdiag.exe program **
Date:2004/05/06 07:08:09
OS :Microsoft Windows XP 5.1.2600 Service Pack 1

[Device information]
Device Name AI0000
Device ADA16-32/2(CB)F

[File Information]
G:\WINDOWS\SYSTEM32\CAIO.DLL 1, 3, 0, 0 2003/10/31 01:30
G:\WINDOWS\SYSTEM32\CMESSAGE.OCX 1, 0, 0, 1 2001/10/26 01:15
G:\WINDOWS\SYSTEM32\CAIODDEL.EXE 1, 1, 3, 0 2003/05/29 01:13
G:\WINDOWS\SYSTEM32\CAIOPP32.DLL 1, 1, 2, 0 2003/08/27 01:12
G:\WINDOWS\SYSTEM32\DRIVERS\CAIO.SYS 1, 1, 2, 0 2003/10/31 01:30
G:\WINDOWS\SYSTEM32\CAIODIAG.EXE 1, 1, 4, 0 2003/10/31 01:14

[Diagnosis]
Initial result [0] Normality completion
Interrupt [0] Normality completion

Analog input 32CH
Input method:Singleend
CH00 [0] Normality completion DATA: 3.74(AFE4hex) RANGE:-1.0 - +1.0V
CH01 [0] Normality completion DATA: 0.16(8200hex) RANGE:-1.0 - +1.0V
CH02 [0] Normality completion DATA: -0.70(7701hex) RANGE:-1.0 - +1.0V
CH03 [0] Normality completion DATA: -0.53(793Dhex) RANGE:-1.0 - +1.0V
CH04 [0] Normality completion DATA: -0.93(7416hex) RANGE:-1.0 - +1.0V
CH05 [0] Normality completion DATA: -0.75(7659hex) RANGE:-1.0 - +1.0V
CH06 [0] Normality completion DATA: -0.63(77FChex) RANGE:-1.0 - +1.0V
CH07 [0] Normality completion DATA: -0.28(7C6Dhex) RANGE:-1.0 - +1.0V
CH08 [0] Normality completion DATA: -0.86(7506hex) RANGE:-1.0 - +1.0V
CH09 [0] Normality completion DATA: -0.77(7623hex) RANGE:-1.0 - +1.0V
CH10 [0] Normality completion DATA: -0.43(7A84hex) RANGE:-1.0 - +1.0V
CH11 [0] Normality completion DATA: -0.21(7B50hex) RANGE:-1.0 - +1.0V
CH12 [0] Normality completion DATA: -0.38(7832hex) RANGE:-1.0 - +1.0V
CH13 [0] Normality completion DATA: -0.16(7DF6hex) RANGE:-1.0 - +1.0V
CH14 [0] Normality completion DATA: -0.12(7E77hex) RANGE:-1.0 - +1.0V
CH15 [0] Normality completion DATA: -0.34(7BA1hex) RANGE:-1.0 - +1.0V
CH16 [0] Normality completion DATA: -0.54(7914hex) RANGE:-1.0 - +1.0V
CH17 [0] Normality completion DATA: -0.44(7A52hex) RANGE:-1.0 - +1.0V
CH18 [0] Normality completion DATA: -0.52(794Chex) RANGE:-1.0 - +1.0V
CH19 [0] Normality completion DATA: -0.41(7AC4hex) RANGE:-1.0 - +1.0V
CH20 [0] Normality completion DATA: -0.68(774Fhex) RANGE:-1.0 - +1.0V
CH21 [0] Normality completion DATA: -0.39(7AF6hex) RANGE:-1.0 - +1.0V
  
```

* The name of the board you have just added is displayed.
- AI-1204Z-PCI

(2) The diagnosis report contains the following data.

- Version of OS
- Device Information
- File Information
- Initialization, interrupts, current input or output state for each channel

Setup Troubleshooting

Symptoms and Actions

Data input or output does not operate correctly

- Run the diagnosis program to check that the device is registered and whether any initialization errors have occurred.
- Is there a problem with the device settings, wiring, or similar? Check the I/O range setting. Also, the input data will be undefined if the wiring terminals are not connected. Ensure that the channels you are using are correctly connected. Connect unused channels to analog ground.
- For voltage input, check by connecting a battery or similar if you do not have any other suitable signal source. Also check that connecting to analog ground reads correctly as 0V.

The board works with the Diagnosis Program but not with an application.

The Diagnosis Program is coded with API-TOOL functions. As long as the board operates with the Diagnosis Program, it is to operate with other applications as well. In such cases, review your program while paying attention to the following points:

- Check the return values of the API functions.
- Refer to the source code for the sample programs.

The OS won't normally get started or detect the device.

Refer to the "Troubleshooting" section of API-AIO(WDM) HELP.

If your problem cannot be resolved

Contact your retailer.

3. External Connection

This chapter describes the interface connectors on the product and the external I/O circuits. Check the information available here when connecting an external device.

How to connect the connectors

Connector shape

To connect an external device to this product, plug the cable from the device into the interface connector (CN1, CN2) shown below.

This product has two interface connectors: the (CN1, BNC connector) for analog inputs and the (CN2, 16-pin pin-header connector) for digital inputs/outputs.

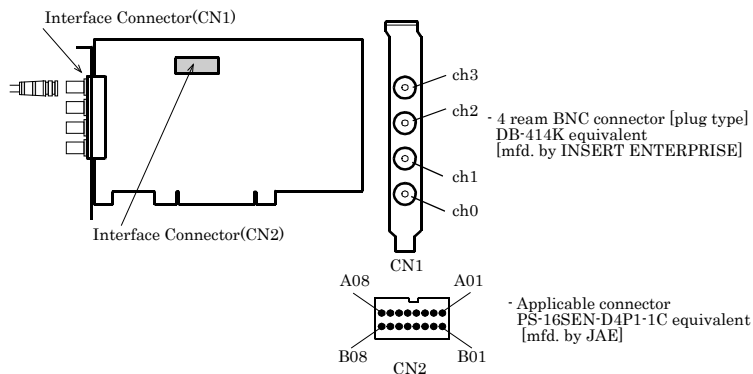

* Please refer to chapter 1 for more information on the supported cable and accessories.

Figure 3.1. Interface Connector Shape

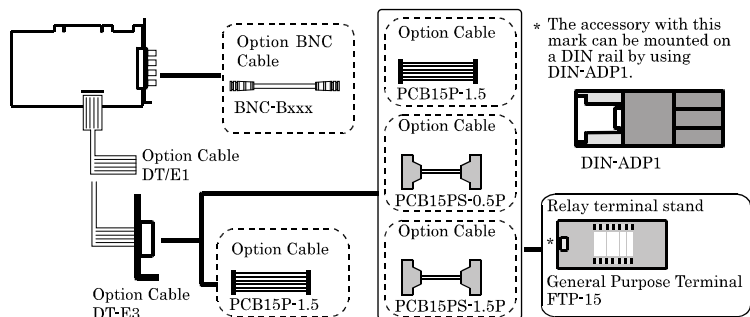

* Please refer to chapter 1 for more information on the supported cable and accessories.

Figure 3.2. Examples of Connecting Options

Connector Pin Assignment

Pin Assignment of CN1

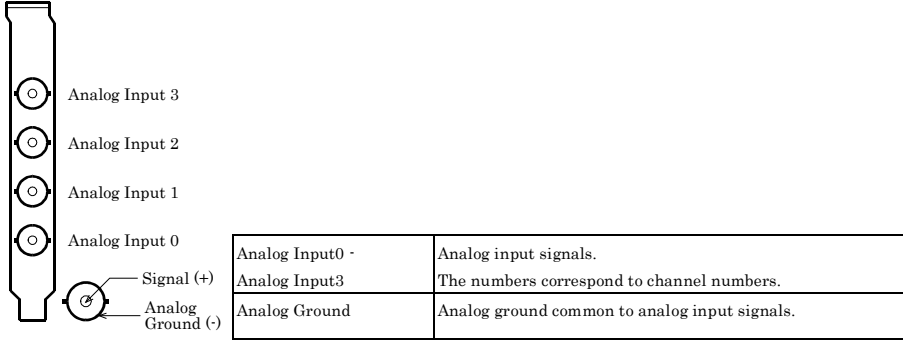

Figure 3.3. Pin Assignment of CN1

⚠ CAUTION

If analog and digital ground are shorted together, noise on the digital signals may affect the analog signals. Accordingly, analog and digital ground should be separated.

Pin Assignment of CN2

	A01	Digital Output 0	B01	Digital Output 1
	A02	Digital Output 2	B02	Digital Output 3
	A03	Digital Ground	B03	Digital Input 0
	A04	Digital Input 1	B04	Digital Input 2
	A05	Digital Input 3	B05	External Start Trigger Input
	A06	External Stop Trigger Input	B06	External Sampling Clock Input
	A07	AI Status Output	B07	Digital Ground
	A08	N.C.	B08	N.C.

Digital Input 0 - Digital Input 3	Digital input signal.
Digital Out 0 - Digital Output 3	Digital output signal.
External Start Trigger Input	External trigger input signal for sampling start conditions
External Stop Trigger Input	External trigger input signal for sampling stop conditions
External Sampling Clock Input	External sampling clock input signal
AI Status Output	Output the status signal.
Digital Ground	Digital ground common to the each signal.
N.C.	No connection to this pin.

Figure 3.4. Pin Assignment of CN2

⚠ CAUTION

Do not connect any of the outputs to the analog or digital ground.
Neither connect outputs to each other. Doing either can result in a fault.

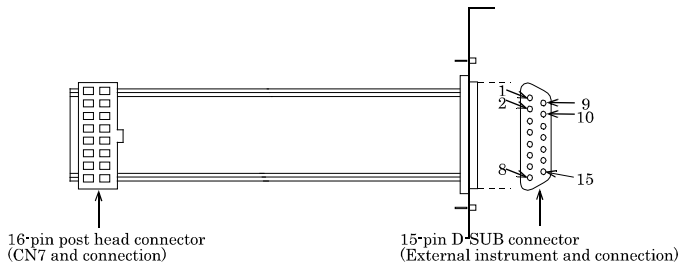

Figure 3.5. Optional cable DT-E3

Digital Output 0	1		9	Digital Output 1
Digital Output 2	2		10	Digital Output 3
Digital Ground	3		11	Digital Input 0
Digital Input 1	4		12	Digital Input 2
Digital Input 3	5		13	External Start Trigger Input
External Stop Trigger Input	6		14	External Sampling Clock Input
AI Status Output	7		15	Digital Ground
Reserved	8			

Figure 3.6. 15 pins D-SUB of optional cable -- Connector Pin Assignment

Analog Input Signal Connection

Single-ended Input

The following figure shows an example of shielded cable connection. For the CN1 each analog input, connect the core wire to the signal line and connect the shielding to ground.

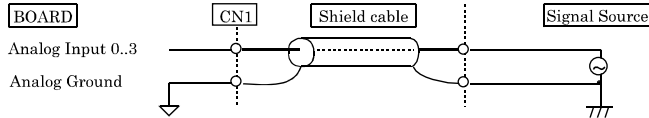

Figure 3.7. Single-ended Input Connection (Shield Cable)

⚠ CAUTION

- Do not touch the external connector (BNC connector) when the power is on. Otherwise this may malfunction, cause a failure due to static electricity.
- If the signal source contains over 5MHz signals, the signal may effect the cross-talk noise between channels.
- If this product and the signal source receive noise or the distance between this product and the signal source is too long, data may not be input properly.
- The analog signal to be input should not exceed the maximum input voltage (based on this product analog ground). If it exceeds the maximum voltage, this product may be damaged.
- Input data remains indeterminate when no input pin is connected. The input pin for the channel not connected to the signal source must be connected to the analog ground.
- An input pin may fail to obtain input data normally when the signal source connected to the pin has high output impedance. If this is the case, change the signal source to one with lower output impedance or insert a high-speed amplifier buffer between the signal source and the analog input board to reduce the effect.

Digital I/O signals and Control signals Connection

This section shows an example of how to connect digital I/O signals and the control signals(external trigger input signals and sampling clock input signal) using flat cable.

User can use an optional cable (DT/E1) or 15-pin D-SUB connector with bracket (DT-E3)and to connect your external devices to CN2.

Pulse (width : about 50nsec) synchronized with internal sampling clock is output to the AI Status Output pin. However, if the sampling clock setting is set to the external sampling clock input, level “L” is always output.

AI Status Output pin is an output in positive logic.

All the digital I/O signals and control signals are LVTTTL level signals.

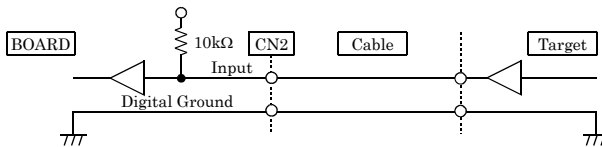

Figure 3.8. Digital Input Connection

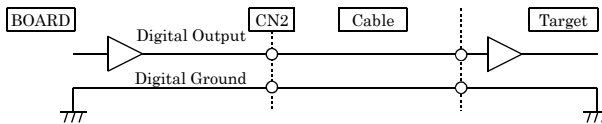

Figure 3.9. Digital Output Connection

⚠ CAUTION

- Do not connect any output signal to the analog or digital ground. Do not interconnect outputs. Doing either can cause a malfunction.
- If connected to each output, a pull-up resistor must be about 10 kΩ to pull up with a 3.3V power source.
- Each input accepts 5V TTL signals.

Reference

For the operation timings for control signal input, see "Timing of External Control Signals" in Chapter 6 "Hardware".

Synchronization Control Connectors

SC Connectors

Controlling simultaneous operations between boards or controlling in sync with events is in part dependent on software performance. In order to enhance the reliability of the entire system and to solve these problems, the board is equipped with SC (Synchronization Control) connectors.

Connecting the SC connectors allows boards of the same or different models to operate in sync with one another.

From the boards connected with the SC cable, select one master board and use others as slaves. On the master board, set the signal to be supplied to the slave boards with the software. On the slave boards, the signal from the master board can be set to either the pacer clock operation start or stop factor.

All board operations can also be stopped with a stop request from the master in case of an error, for example, or when requested from a slave board. A maximum of 16 boards can be connected including the master.

For more information on the setup procedure, see the driver software online help.

Example 1: When clock start and stop requirements are set the same for multiple boards

In order to synchronize master clock start and stop with slave boards you can build a synchronous system which does not depend on software processing capabilities.

If the board model is the same, data remains synchronized among boards even when channels are expanded. When board models are different, data still remains compatible since operating clock start and stop are dependent on the master.

- (1) Connect the SC cable.
- (2) Designate master/slave with the software.
- (3) Assign to the connectors the clock start and stop signals to be output from the master.
- (4) Set up slave boards so they can utilize all signals.
- (5) Start in order of slave to master boards.

CAUTION

- When clock signals are assigned to the synchronization control connector, the maximum clock frequency is restricted to 5MHz.
 - When signals are assigned to the synchronization control connector, a delay of approximately 100nsec occurs at the slave board.
-

Example 2: When controlling slave operations with master's internal events

By outputting an internal event (interrupt) occurring on the master board, the slaves can start operating in sync with that signal.

- (1) Connect the SC cable.
- (2) Designate master/slave with the software.
- (3) Assign to the connector the event signal to be output from the master.
- (4) Set signals from the master to the start requirements on the slave boards.
- (5) Start in order of slave to master boards.

Connecting the SC Connectors (CN3, CN4)

This product is equipped with sync signal control connectors (CN3, CN4) for connecting a sync signal cable. When the cable is connected, multiple boards can operate in sync with one another.

Connection Procedure

Connect the sync signal cable when two or more boards need to operate in sync with one another. Connect CN3 with a smaller ID number to CN4 with a greater ID number with the cable. You should only use the cable that came with the board.

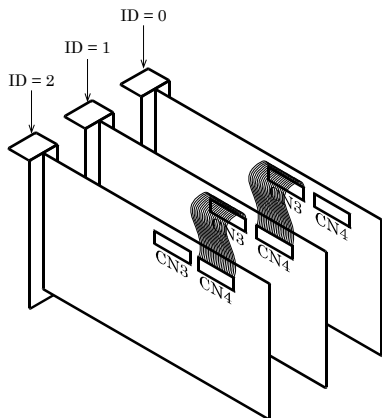

Figure 3.10. Connecting Cables

4. Functions

This chapter explains the function that can be achieved by hardware and driver's combinations. The driver indicates the thing of API-AIO(WDM) as long as there is no annotation.

Analog Input Function

This product converts analog signals to digital data according to the resolution and stores it in memory. You can set a variety of conditions for analog input, including the input channel, sampling period, and sampling start/stop conditions.

Analog input processes are classified as follows:

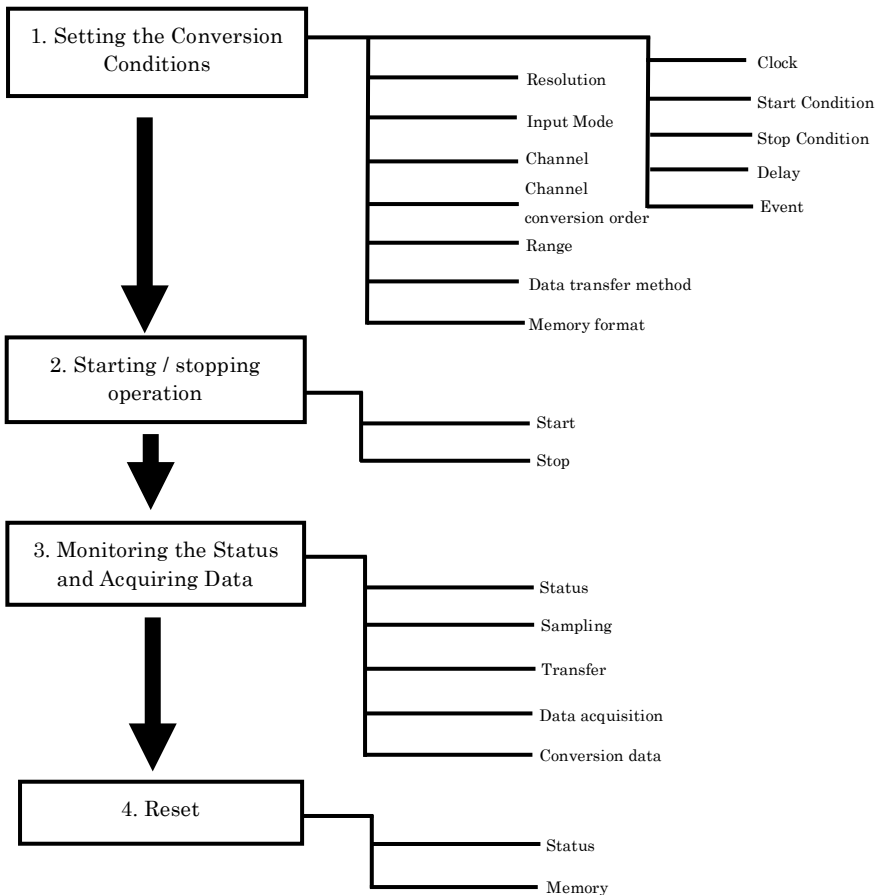

1. Setting the Conversion Conditions

First, set the conditions for executing analog input.

Resolution

“Resolution” signifies the number of bits used by an analog input device to represent analog signals. The higher the resolution, the more finely the voltage range is segmented, allowing the device to convert analog values to digital equivalents more precisely.

A device with a resolution of 12bit divides the range width into 4096 segments.

When the device covers the range of 0 - 10 V, the minimum unit of converted voltages is $10 \div 4096 \approx 2.44\text{mV}$.

If the device has a resolution of 16bit, it is $10 \div 65536 \approx 0.153\text{mV}$ instead.

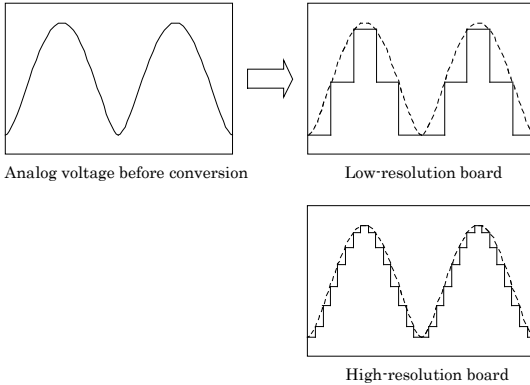

AI-1204Z-PCI : The resolution is 12bit.

Input Mode

“Input Mode” indicates the method of connecting analog input signals.

This product can only be setup to use single-ended inputs.

Channel

“Channel” means each channel number for analog input signals.

For individual channel numbers, see “How to connect the connectors” to “Connector Pin Assignment” in Chapter 3 “External Connection”.

You can specify an arbitrary number of points of analog input by setting the channels by means of software.

Channel conversion order

Simultaneous sampling is performed for the specified number of channels. Data is saved sequentially from channel 0 as shown below.

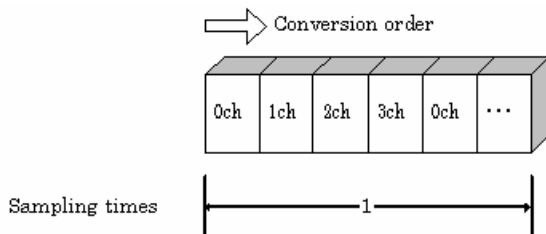

If you wish, you can specify a different channel conversion order.

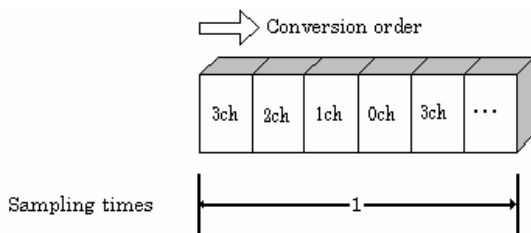

Range

”Range” means the range of voltages at which analog input can be performed.

AI-1204Z-PCI : The input range is set by software.

Data transfer method

You can select between device buffer mode, which saves conversion data in a conversion data memory area either on the device or in the driver, or user buffer mode which saves the conversion data in application memory.

- **Device buffer mode**

When conversion starts, data is saved in the device buffer (memory on the device itself or in the driver).

The device buffer can operate as FIFO or ring memory.

The application calls an API function at an appropriate timing and fetches the conversion data from the device buffer.

Device buffer mode is simpler to use than user buffer mode as it handles data by sampling count and API functions are provided to retrieve conversion data directly as voltage values.

As functions are provided to meet most practical requirements, device buffer mode is usually the best option.

- **User buffer mode**

A region of application memory to store the conversion data is reserved before starting conversion and specified to the driver.

When conversion starts, conversion data is transferred via the driver directly to the application memory.

Whether or not to overwrite memory can be specified in user buffer mode.

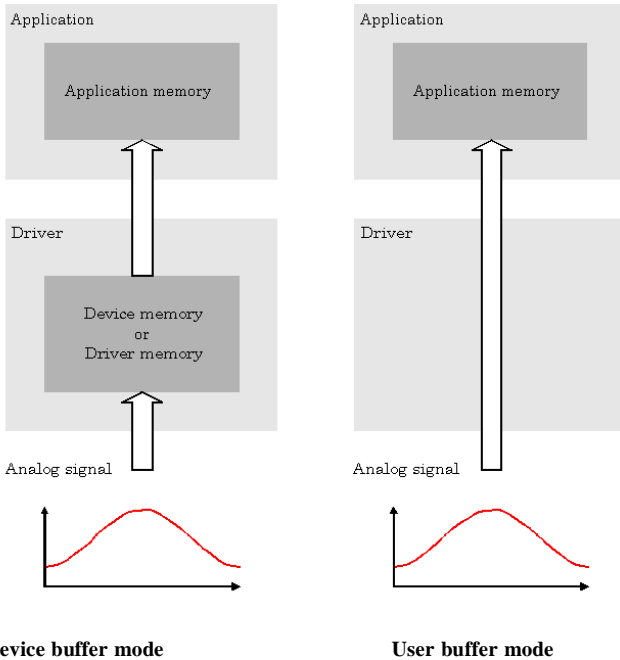

Memory format

The memory format used by device buffer mode and user buffer mode can be specified by software.

Device buffer mode

- FIFO format

In the FIFO (First In First Out) format, input data items are read from memory in the same order in which they were written to the memory. Input data items are fed out of the memory sequentially, where the oldest one is always read from the memory. The status monitor and application notification functions are provided, which check and report the state in which the memory has stored a fixed amount of data or in which the memory has become full.

The FIFO memory is used to obtain all input data from analog input in a short or infinite period of time.

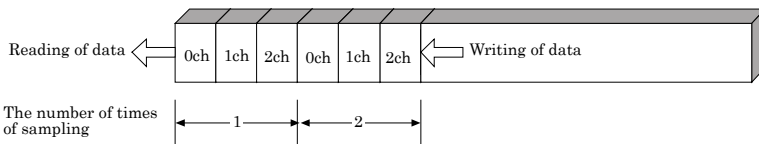

- Ring format

In the ring format, the memory contains storage areas arranged in a ring. Input data items are written to the memory sequentially. When it stores data exceeding the limit, it overwrites the area storing the previous item of input data. The status monitor and application notification functions are provided, which check and report the state in which data has been written to certain areas of memory.

The ring memory is used to obtain data where conversion has stopped due to some event, usually without obtaining data in the normal state.

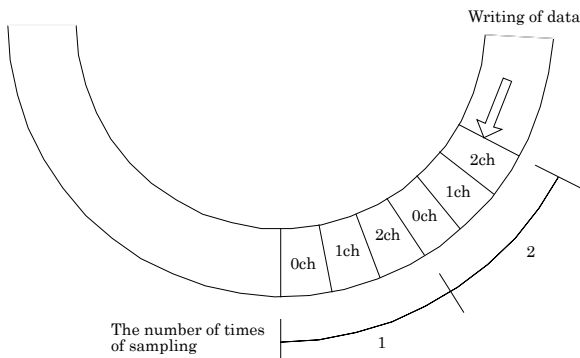

User buffer mode

- No overwriting

Data transfer halts when conversion data transfer reaches the end of the user buffer.
This memory format is useful if the number of samples is known in advance.

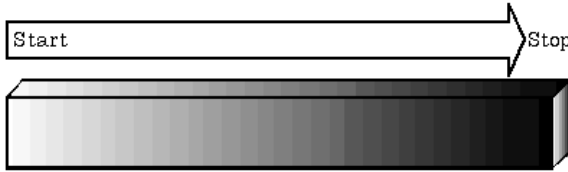

- Permit overwriting

Data transfer does not halt when conversion data transfer reaches the end of the user buffer.
Data transfer continues to overwrite memory until the conversion stop condition is established.
This mode can be used for long term monitoring or for continuous sampling when all data must be captured.

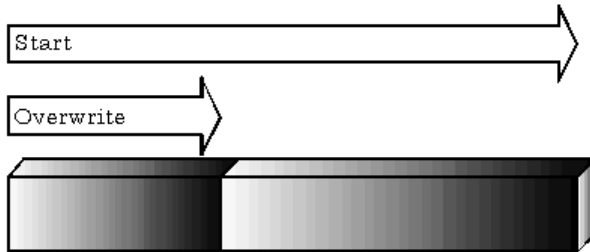

Clock

The sampling clock controls the sampling frequency. You can select either the internal sampling clock, external sampling clock, or the output of the event controller.

- Internal sampling clock

The clock signal from the clock generator on this product is used.

- External sampling clock

The edge of the digital signal input from an external device is used for the sampling clock.

- event controller output

A specified output of the event controller is used as the sampling clock. Refer to the explanation of the event controller functions or to the driver help for details about the event controller.

Start Condition

The condition for controlling the start of sampling can be selected from among software, input data comparison, external trigger and event controller output. The conditions for controlling the start and stop of sampling are completely independent of each other; they can be set separately.

- Software

This product starts sampling and storing input data to memory immediately after the operation start command is issued.

- Input data comparison

When the operation start command is issued, this product compares the analog signal input through a specified channel to the value of the preset comparison level. If the analog signal satisfies the condition, this product starts storing input data.

Level comparison conditions are set as two conditions: level and direction.

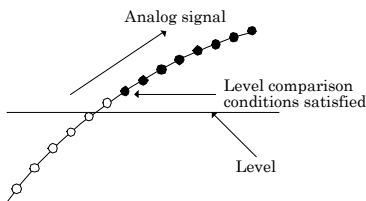

The above sketch shows that the level comparison condition is satisfied in the rising direction.

The start condition is satisfied when the analog signal at the specified channel passes the comparison level in the rising direction. Input data items are stored to memory, starting with those at solid dots.

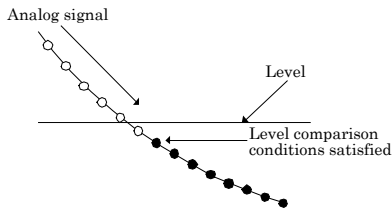

The above sketch shows that the level comparison condition is satisfied in the falling direction.

The start condition is satisfied when the analog signal at the specified channel passes the comparison level in the falling direction. Input data items are stored to memory, starting with those at solid dots.

If you set the level comparison directions to both directions, the start condition is satisfied when the analog signal passes the level both in the rising and falling directions.

- Conversion data in-range comparison

The in-range compare start condition is established when the level on the specified analog channel enters the range specified by level 1 and level 2. Saving of conversion data to memory is performed for the sample points indicated by the black dots. If the analog signal already exist within the in-range, the convention starts immediately.

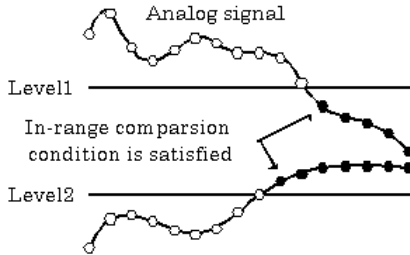

Start condition : $\text{Level 2} \leq \text{Analog signal} \leq \text{Level 1}$

- Conversion data out-of-range comparison

The out-of-range compare start condition is established when the level on the specified analog channel is outside the range specified by level 1 and level 2. Saving of conversion data to memory is performed for the sample points indicated by the black dots. If the analog signal already exist within the out-range, the convention starts immediately.

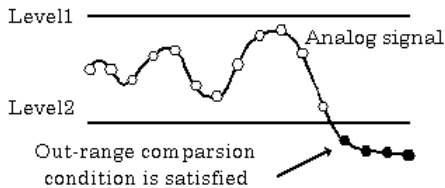

Start condition : $\text{Analog signal} \leq \text{Level 2}$ or $\text{Level 1} \leq \text{Analog signal}$

- External trigger

This product starts waiting for an external control signal as soon as the operation start command is output. Sampling and data transfer to memory start when the specified edge (rising edge or falling edge) is input from the external control signal.

- Event controller output

This product starts waiting for an external control signal as soon as the operation start command is output. Sampling and data transfer to memory start when the specified event controller output is received.

Refer to the explanation of the event controller functions or to the driver help for details about the event controller.

Stop Condition

The condition for controlling the stop of sampling can be selected from among the last sampling count, input data comparison, an external trigger, event controller output and software abort.

This product stops sampling whenever an error occurs irrespective of the stop condition setting.

- Last sampling count
This product stops sampling after storing input data to memory for the specified number of times of sampling.

- Input data comparison

Once this product has started sampling, it compares the analog signal input through a specified channel to the value of the preset comparison level. If the analog signal satisfies the condition, this product stops sampling.

Level comparison conditions are set as two conditions: level and direction.

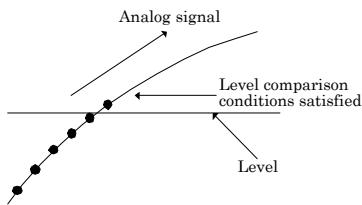

The above sketch shows that the level comparison condition is satisfied in the rising direction.

The stop condition is satisfied when the analog signal at the specified channel passes the comparison level in the rising direction. Input data items are stored to memory, ending until those at solid dots.

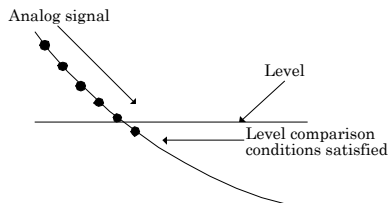

The above sketch shows that the level comparison condition is satisfied in the falling direction.

The stop condition is satisfied when the analog signal at the specified channel passes the comparison level in the falling direction. Input data items are stored to memory, ending until those at solid dots

If you set the level comparison directions to both directions, the start condition is satisfied when the analog signal passes the level both in the rising and falling directions.

- Conversion data in-range comparison

The in-range compare stop condition is established when the level on the specified analog channel enters the range specified by level 1 and level 2. Saving of conversion data to memory is performed for the sample points indicated by the black dots. If the analog signal already exist within the in-range, the convention starts immediately.

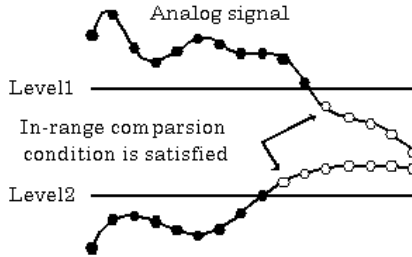

Start condition : $\text{Level 2} \leq \text{Analog signal} \leq \text{Level 1}$

- Conversion data out-of-range comparison

The out-of-range compare stop condition is established when the level on the specified analog channel is outside the range specified by level 1 and level 2. Saving of conversion data to memory is performed for the sample points indicated by the black dots.

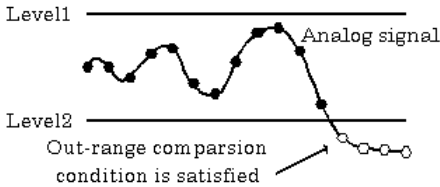

Start condition : $\text{Analog signal} \leq \text{Level 2}$ or $\text{Level 1} \leq \text{Analog signal}$

- External trigger

This product starts waiting for an external control signal after the specified number of samples have been performed. Sampling stops when the specified edge (rising edge or falling edge) is input from the external control signal.

- Software

Sampling continues indefinitely in this mode. Sampling only stops in response to a software command or an error.

- Event controller output

Sampling stops when the specified event controller output is received.

Refer to the explanation of the event controller functions or to the driver help for details about the event controller.

Delay

Delayed sampling is performed after the sampling stop condition is satisfied.

When a sampling stop condition other than the software abort command is satisfied, this product performs sampling for the specified number of times of delayed sampling to store input data to memory. If you set the number of times of delayed sampling to 0, this product stops sampling the moment the sampling stop condition is satisfied.

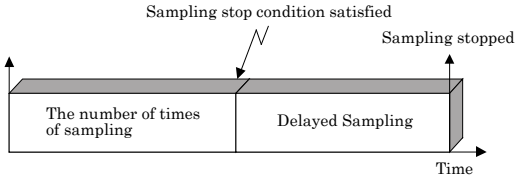

Event

"Event" works as a function for reporting the occurrence of a certain board state to the application.

The following events can be used in combination depending on the purpose of usage.

- "AD conversion start condition satisfied" event
This event occurs when the AD conversion start condition is satisfied. The event is nullified when the conversion start condition is "software".
- "End of device operation" event
This event occurs when the entire operation is completed.
- "Stored specified sampling times" event
This event occurs when sampling has been performed for the number of times set by software. This event can only be used in device buffer mode.
- "Specified number of transfers" event
This event occurs each time a specified number of samples (set by software) has been completed. This event can only be used in user buffer mode.
- Overflow event
This event occurs at an attempt to store input data with the memory full.
- Sampling clock error event
This event occurs when conversion stops as an error occurs due to a sampling clock period that is too short.
- AD conversion error event
This event occurs when conversion stops due to an AD conversion error.

2. Starting/Stopping Operation

Sampling is started by the software command.

Once started, sampling can be stopped by the software command at any timing.

3. Monitoring the Status and Acquiring Data

Software commands are used to monitor the operation status of the device and to acquire input data from memory. Status monitoring and data acquisition can be performed even during sampling.

Status

The current state of the device can be checked by obtaining the device status.

The following types of device status are available:

- Device operating
The “device operating” status remains ON, after the execution of the sampling start command until this product completes conversion, aborts operation due to an error, or stops sampling in response to the command.
- Waiting for start trigger
This status remains ON, after this product starts sampling until the start trigger is input, if the conversion start condition is an external trigger or level comparison. The status is set to OFF when the input trigger is input to start conversion.
- Specified sampling data stored
This status is set to ON when input data stored in memory has reached the amount corresponding to the preset number of times of sampling.
If the memory format is FIFO, the status is set to OFF when the amount of input data in the memory falls below the value corresponding to the preset number of times of sampling as data is acquired. Once the status is set to ON when the memory format is ring, it remains ON until it is reset.
- Overflow
An overflow error occurs when an attempt is made to store input data to memory while it has been full of input data.
When the memory format is FIFO, this product stops conversion.
When the memory format is ring, this product continues conversion while overwriting existing data with new one.
- Sampling clock error
This error occurs when the sampling clock period is too short.
- AD conversion error
If the “device operating” status remains ON (without terminating conversion) for an extended period of time, the driver regards that state as an operation error and sets this status to ON. This error stops sampling.

Sampling

The number of sampled items of input data stored in memory can be obtained by the software command. This command can only be used in device buffer mode.

Transfer

The number of sampled items of input data stored in memory can be obtained by the software command. This command can only be used in user buffer mode.

Data acquisition

When using the device buffer, input data stored in memory can be acquired by the software command. Illustrated below is the relationship between the number of times of sampling of input data stored in memory and the input channels.

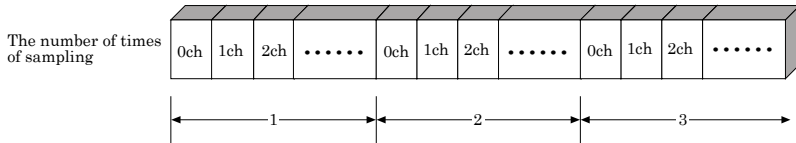

Input data is acquired differently depending on the memory format used.

- Data acquisition in FIFO format

When FIFO memory is used, the oldest data is always read first.

The following sketch shows an image of data acquisition in FIFO format.

When data is acquired from the memory, the free memory space increases by that data size. When data is acquired next, the oldest one of the existing data items is taken from the memory in the same way.

The FIFO memory deletes data once that data is acquired.

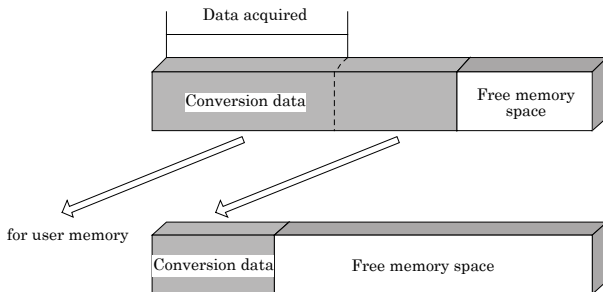

- Data acquisition in ring format

When ring memory is used, data is read always with respect to the current input data write position.

The following sketch shows an image of data acquisition in ring format.

The sampling count obtained is always the number of times of sampling for up to the latest data (shaded portion below).

The larger the number of samples taken, the older the data item acquired first.

As the ring memory retains data even after that data is acquired, you can fetch the same data any number of times.

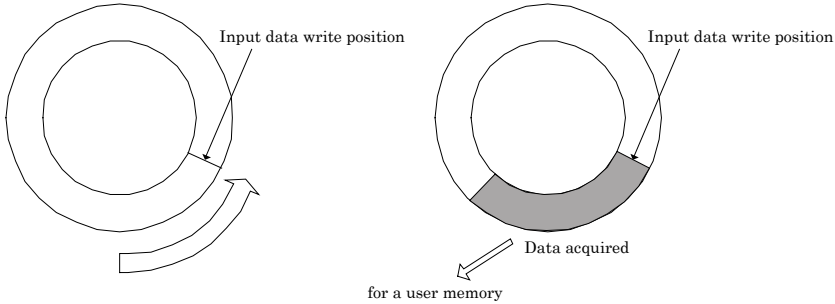

When using a user buffer, the conversion data is transferred directly to application memory by the driver.

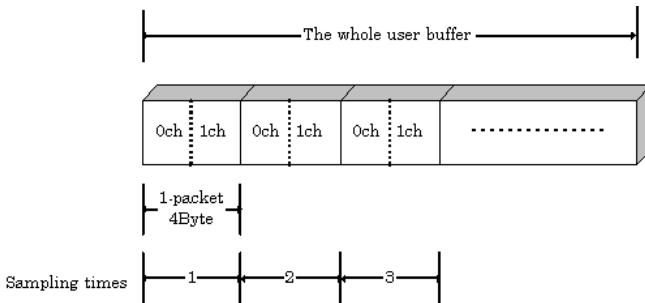

The figure above shows how to set the data in the user buffer for the case when 2channels (0 and 1channel) are used. Data transfer is performed using a single 4 byte packet which is the minimum data transfer size.

Each packet contains two DA conversion data values in binary format. In the above example, the lower two bytes of the packet contain the channel 0 data and the upper two bytes contain the channel 1 data.

When using 2channels, each packet (each data transfer) contains the data for one sampling.

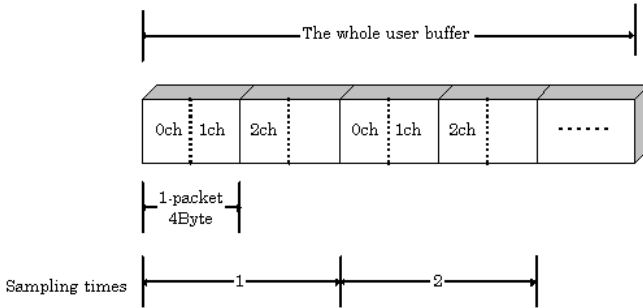

The figure above shows how to set the data in the user buffer for the case when 3 channels (0, 1, and 2 channels) are used. As each packet contains two conversion data values, the uppermost two bytes are not used if an odd number of channels is being used, as in the example above. When using 3 channels, two packets (two data transfer operations) are used for each sampling.

Conversion data

The following equation represents the relationship between input data and voltage.

Voltage = Input data x (Max. range value – Min. range value) / Resolution + Min. range value

The value of resolution for the 12bit device is 4096; that for the 16bit device is 65536.

< ±10V range >

The following tables show the relationship between AD conversion data and voltage.

Voltage	Conversion data (12bit)	Voltage	Conversion data (16bit)
9.995V	4095	9.99970V	65535
:	:	:	:
0.005V	2049	0.00030V	32769
0V	2048	0V	32768
-0.005V	2047	-0.00030V	32767
:	:	:	:
-10.000V	0	-10.000V	0

Ex.: When input data 3072 is input at a resolution of 12bit in the ± 10-volt range

$$\begin{aligned} \text{Voltage} &= 3072 \times (10 - (-10)) \div 4096 + (-10) \\ &= 5.0 \end{aligned}$$

< 0 - 10V range >

The following tables show the relationship between AD conversion data and voltage.

Voltage	Conversion data (12bit)	Voltage	Conversion data (16bit)
9.998V	4095	9.99985V	65535
:	:	:	:
5.002V	2049	5.00015V	32769
5V	2048	5V	32768
4.998V	2047	4.99985V	32767
:	:	:	:
0V	0	0V	0

Ex.: When input data 3072 is input at a resolution of 12bit in the 0 - 10-volt range

$$\begin{aligned} \text{Voltage} &= 3072 \times (10 - 0) \div 4096 + 0 \\ &= 7.5 \end{aligned}$$

4.Reset

Various states can be reset by executing the following reset commands:

Status

This command resets the sampling clock error status and AD conversion error status.

Memory

This can only be used when the transfer mode is set to device buffer mode.

This command resets the following memory related states.

- Resets the conversion data in memory.
- Resets the sampling count to 0 when a stop trigger is input.
- Resets the buffer overflow status.
- Resets the status information for the specified data save count.

Digital Input Function

Input bit

Individual digital input points are called input bits.

When the number of input points of a device is 4, the bits are determined as bit 0 - bit 3.

	bit3	bit2	bit1	bit0
--	------	------	------	------

Input in Bits

The state 1 (ON) or 0 (OFF) of each input bit can be obtained by specifying the bit.

Input in Bytes

Individual input bits can be input in byte units.

When the number of input points of the device is 4, the individual input bits are arranged as shown below and the byte data to be input is a value between 0 and 15 depending on the states of the bits.

EX. Input of bit 3 (OFF), bit 2 (ON), bit 1 (OFF), and bit 0 (ON)

Byte data = 5(5H)

	bit3	bit2	bit1	bit0
	0(OFF)	1(ON)	0(OFF)	1(ON)

Digital filter

A digital filter can be used on the input bits.

The filter time can be set to "don't use", 50ns, 1μs, 10μs, or 100μs by software.

Digital Output Function

Output bit

Individual digital output points are called output bits.

When the number of output points of a device is 4, the bits are determined as bit 0 - bit 3.

	bit3	bit2	bit1	bit0
--	------	------	------	------

Output in Bits

The state of each output bit can be changed to ON or OFF by specifying the bit and setting it to 1 or 0.

Output in Bytes

Individual output bits can be output in byte units.

When the number of output points of the device is 4, the individual output bits are arranged as shown below and byte data to be output is a value between 0 and 15.

Ex. Output of bit 3 (ON), bit 2 (OFF), bit 1 (ON), and bit 0 (OFF)

Byte data = 10(AH)

	bit3	bit2	bit1	bit0
	1(ON)	0(OFF)	1(ON)	0(OFF)

Event Controller Function

Overview of the event controller

The event controller is used to determine how the control signals between the various functions are interlinked. Customizing the way in which the control signals are used allows more advanced operations to be implemented by synchronizing the different functions within a single device and by synchronizing operation between multiple devices.

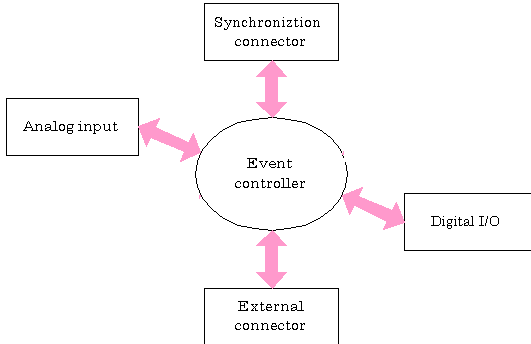

The arrows in the figure show the flow of control signals.

The main control signals include the operation start signals, operation stop signals, and clock signals.

Example of using the event controller

The following example shows how to configure the event controller to synchronize analog input operation between two devices using the synchronization connector.

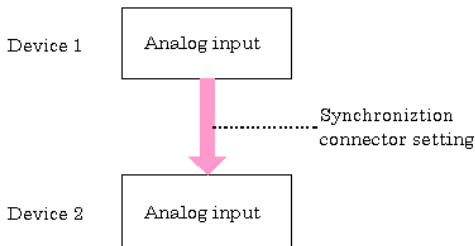

Synchronizing between two devices is performed by connecting control signals from device 1 to device 2.

1. Set the analog input start condition (Device 1)
This example specifies software activation.
2. Setting up the event controller (Device 1)
Setup the event controller to connect the software start signal to the synchronization connector for output to device 2. The signal destination is synchronization bus master signal 1 and the signal source is the analog input software start signal.

3. Set the clock to use for analog input (Device 1)
This example specifies the internal clock.
4. Setting up the event controller (Device 1)
Setup the event controller to connect the internal clock to the synchronization connector for output to device 2.
The signal destination is synchronization bus master signal 2 and the signal source is the internal clock signal for analog input. Device 2 performs analog input in accordance with the control signals received from device 1.
5. Set the analog input start condition (Device 2)
As the control signal from device 1 is used as the start condition, set this as an output from the event controller.
6. Setting up the event controller (Device 2)
The software start signal from device 1 is connected to synchronization bus master signal 1 which in turn is connected to synchronization bus slave signal 1 in the synchronization connector. Accordingly, setup the event controller to use synchronization bus slave signal 1 as the conversion start signal for device 2.
The signal destination is the conversion start signal for analog input and the signal source is synchronization bus slave signal 1.
7. Set the clock to use for analog input (Device 2)
As the control signal from device 1 is used as the clock, set this as an output from the event controller.
8. Setting up the event controller (Device 2)
The internal clock signal from device 1 is connected to synchronization bus master signal 2 which in turn is connected to synchronization bus slave signal 2 in the synchronization connector. Accordingly, setup the event controller to use synchronization bus slave signal 2 as the sampling clock for device 2.
The signal destination is the sampling clock for analog input and the signal source is synchronization bus slave signal 2.
9. Start conversion
In this example, conversion is started first on device 2. When analog input starts on device 1, analog input starts simultaneously on device 2.

5. About Software

CD-ROM Directory Structure

```

\
|— Autorun.exe           Installer Main Window
|  |— Readmej.html      Version information on each driver (Japanese)
|  |— Readmeu.html      Version information on each driver (English)
|  .
|  |— APIPAC            Each installer
|  |  |— AIO
|  |  |  |— DISK1
|  |  |  |— DISK2
|  |  |  |— .....
|  |  |  |— DISKN
|  |  |— AioWdm
|  |  |— CNT
|  |  |— DIO
|  |  |— .....
|  .
|  |— HELP              HELP file
|  |  |— Aio
|  |  |— Cnt
|  |  |— .....
|  .
|  |— INF              Each INF file for OS
|  |  |— WDM
|  |  |— Win2000
|  |  |— Win95
|  .
|  |— Readme           Readme file for each driver
|  .
|  .
|  |— Release          Driver file on each API-TOOL
|  |  |— API_NT        (For creation of a user-specific install program)
|  |  |— API_W95
|  .
|  |— UsersGuide       Hardware User's Guide (PDF files)

```

About Software for Windows

The bundled CD-ROM “Driver Library API-PAC(W32)” contains the functions that provide the following features:

- Analog input or output through arbitrary channels
- Analog input at arbitrary intervals using the internal or external sampling clock
- Simultaneous monitoring of the termination of analog input sampling, buffer memory usage, and interrupt events such as occurrences of errors
- Driver option check using a demo driver even without the board installed

For details, refer to the help file. The help file provides various items of information such as “Function Reference”, “Sample Programs”, and “FAQs”. Use them for program development and troubleshooting.

Accessing the Help File

- (1) Click on the [Start] button on the Windows taskbar.
- (2) From the Start Menu, select “Programs” – “CONTEC API-PAC(W32)” – “AIOWDM” – “API-AIO(WDM) HELP” to display help information.

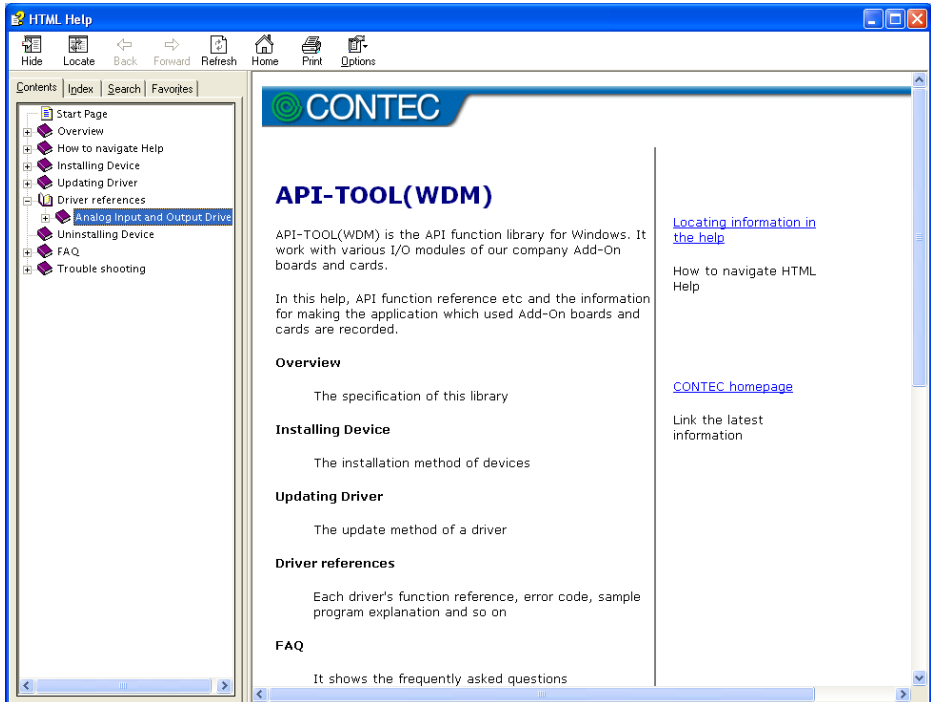

Using Sample Programs

Sample programs are provided for each of the basic operations. You can use these to check the operation of the board and as a reference when writing your own programs.

To use the sample programs, specify the device name in the property page for the program.

The sample programs are stored in \Program Files\CONTEC\API-PAC(W32)\AIOWDM\Samples.

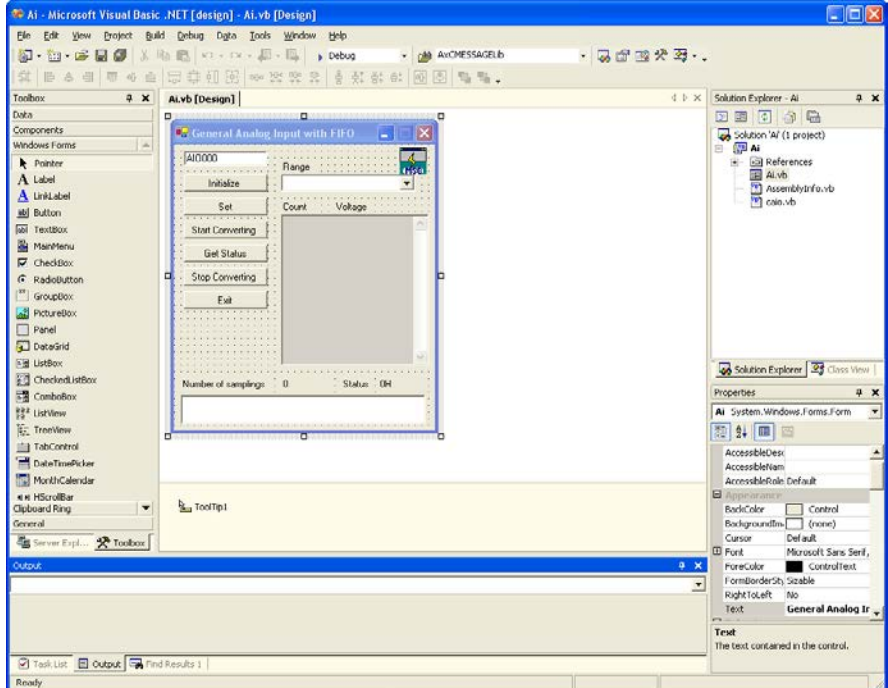

Running a Sample Program

- (1) Click on the [Start] button on the Windows taskbar.
- (2) From the Start Menu, select “Programs” - “CONTEC API-PAC(W32)” - “AIOWDM” - “SAMPLE...”.
- (3) A sample program is invoked.

Sample Programs - Examples

Analog input

Simple sample program

- SingleAi Perform single analog input from specified channel
- MultiAi Perform single analog input from multiple channels

Device buffer

- Ai Perform standard analog input using a FIFO buffer
- AiPoll Perform standard analog input by polling
- AiEx Perform analog input for multiple channels using a FIFO buffer
- AiLong Perform long-duration analog input using a FIFO buffer
- AiExt Perform analog input using an external clock
- AiTrg Perform analog input using an external trigger to start and stop operation
- AiLevel1 Use a level trigger to start analog input
- AiLevel2 Use a level trigger to stop analog input
- Ai2 Perform standard analog input using more than one device
- AiCall Perform analog input using a callback routine
- AiSync1 Perform multi-channel analog input using two devices

User buffer

- AiUser1 Perform analog input for a specified duration using a user buffer
- AiUser2 Perform analog input indefinitely using a user buffer

Digital input/output

- DioBit Perform digital I/O using bit values
- DioByte Perform digital I/O using port values

Others

- Convert Data conversion
- Multi1 Synchronized analog I/O

Usage of Utility Program

Program for Measurement of Function Execution Speed

The execution time of some main functions can be measured in a function execution speed measurement program. To use a function execution speed measurement program, click the [execution time measurement] button in the diagnostic program.

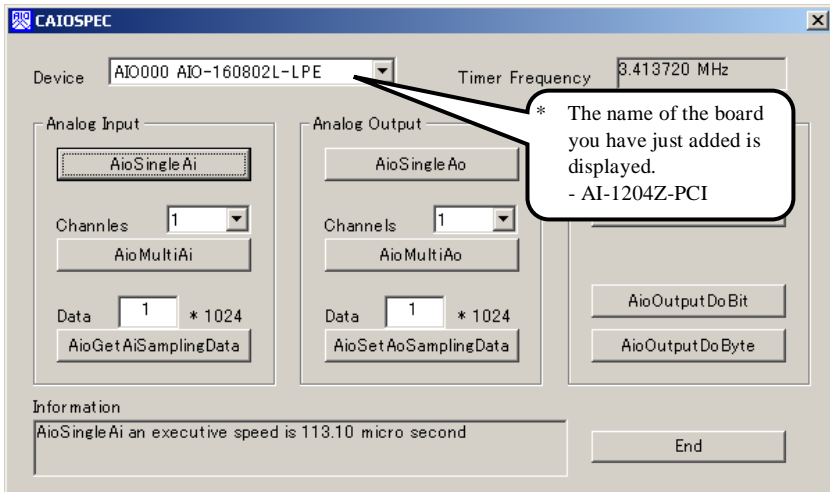

Procedure

- (1) Chose the measure device from device list.
- (2) Click the button written with the function name to measure the execution speed of the function. Please choose from a list the number of channels used for conversion in function AioMultiAi.
- (3) End the application with an [end] button.

Analog Input Measurement Tool

It is an analog input measurement utility to carry out infinity sample in the FIFO memory. Once the conversion data of memory accumulates to a certain quantity, the event occurs and data of the memory is acquired. Data in the FIFO memory can be confirmed visually.

The number of channels used, the internal/external clock, the conversion speed, and the sampling frequency at which an event generates can be set. Since the notification of a sampling clock error event is sent, please make use of it for the conversion spec measurement under various conversion conditions.

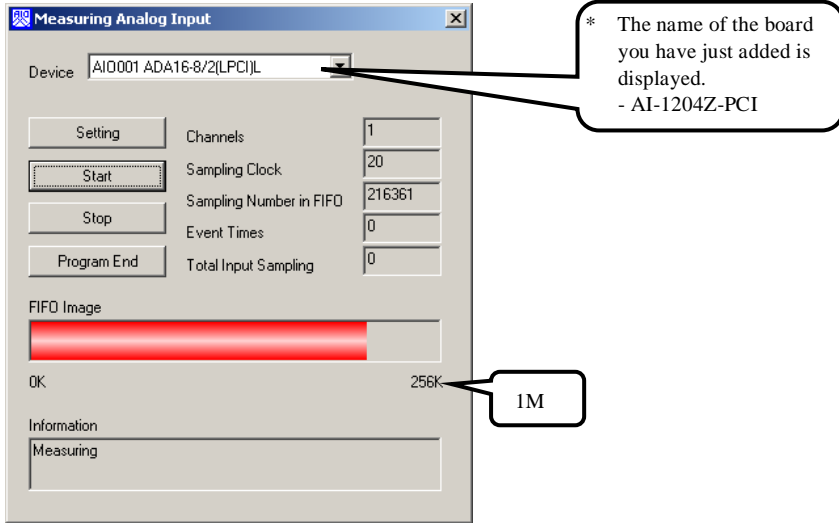

Procedure

- (1) Chose the device name of the device to be used from the upper left combo box, and click the setting button.
- (2) The conversion conditions are set on the screen of the analog input setting.

Once an input is done at the sampling frequency specified as data taking-in sampling, an event occurs and data will be acquired. Click the OK button to finish setting the conditions, and returns to former screen.

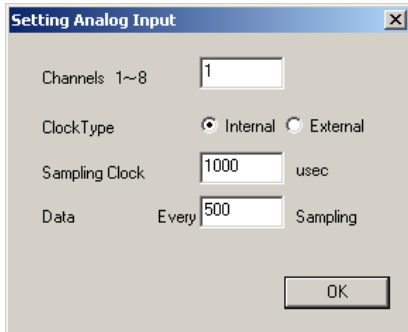

- (3) Start the measurement with measurement start button. The various states during the conversion are displayed.

The number of the samplings in FIFO is :

It is conversion data taken in the memory. This can be visually checked in a "memory image".

Event generation sampling frequency :

When the number of input sampling in FIFO reaches this frequency, the event generates.

Total input sampling frequency :

It is the total number of samplings for application in the memory.

Measurement may stop by the following errors.

Sampling clock error :

It means that the conversion speed is too fast and the driver processing is not in time when converting at the internal clock.

The cycle of the clock is too fast when converting it at the external clock. Moreover, the cause by noise etc. is also concerned.

Buffer overflow :

The memory overflows since the conversion speed is too fast compared with the one at which data is inputted.

- (4) Click the "stop" button, and measurement stops.

Uninstalling the Driver Libraries

The method used to uninstall API-PAC(W32) differs depending on which OS you are using. Follow the procedure given below.

Uninstall procedure for Windows 7 and Windows Vista

< Uninstalling the device driver >

1. Run Device Manager. From [My Computer] - [Control Panel], select [System] and then select the [Device Manager] tab.
(You can also open Device Manager by right clicking on My Computer and selecting Properties.)
2. All of the hardware that uses the API-TOOL(WDM) driver is registered under the CONTEC Devices tree.
Open the device tree, select the hardware to uninstall, and then right-click the hardware.
From the popup menu, select [Uninstall].

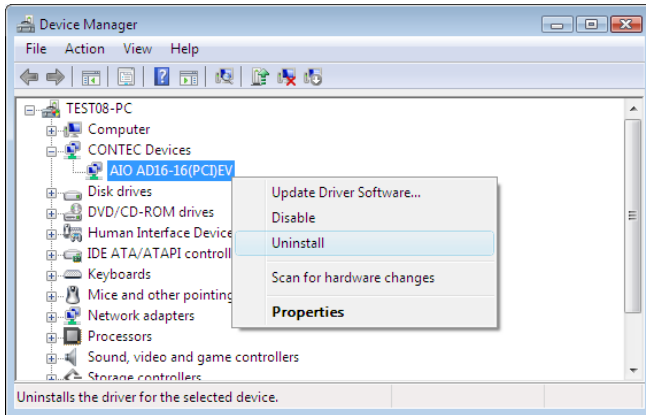

3. A dialog box opens asking you to confirm whether to uninstall. Select the [Delete the driver software for this device] checkbox, and then click [OK].

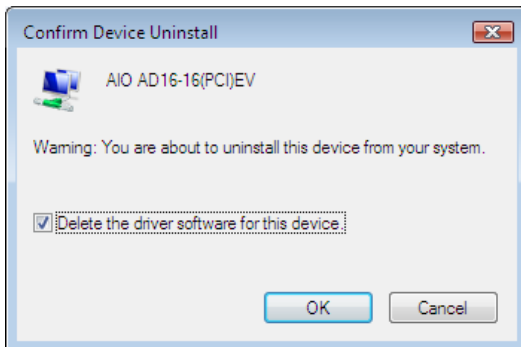

< Uninstall the development environment >

Use [My Computer] - [Control Panel] - [Add and Remove Applications] to uninstall the development environment.

Select [CONTEC API-*** (WDM) VerX.XX (development environment)] and then click [Uninstall].

* "****" contains the driver category name (AIO, CNT, DIO, SMC, etc.).

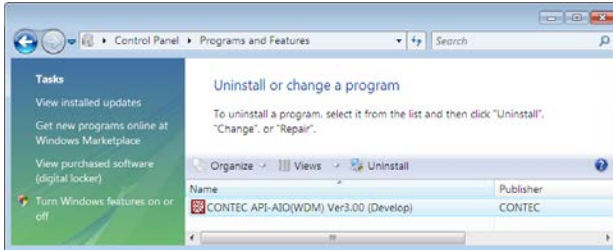

Uninstall procedure for Windows XP and Windows 2003 Server

< Uninstall the device driver >

Use [My Computer] - [Control Panel] - [Add and Remove Applications] to uninstall the device driver. Select [Windows driver package - CONTEC (****)] and then click [Change/Remove].

* "****" contains the driver category name (caio, cnt, cdio, csmc, etc.).

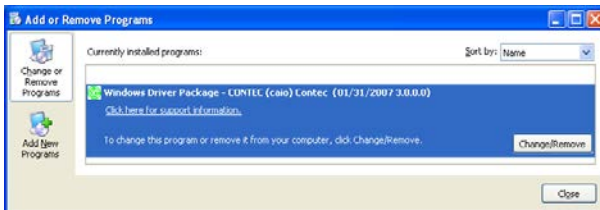

< Uninstall the development environment >

Use [My Computer] - [Control Panel] - [Add and Remove Applications] to uninstall the development environment.

Select [CONTEC API-*** (WDM) VerX.XX (development environment)] and then click [Change/Remove].

* "****" contains the driver category name (AIO, CNT, DIO, SMC, etc.).

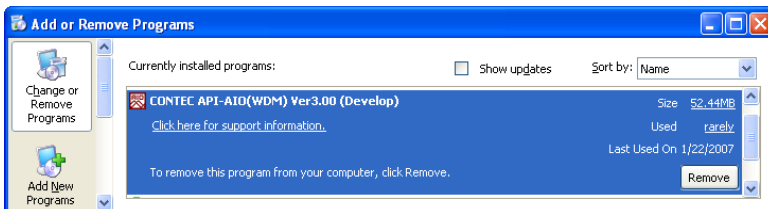

Uninstall procedure for Windows Me

< Uninstall the device driver >

Use [My Computer] - [Control Panel] - [Add and Remove Applications] to uninstall the device driver. Select [CONTEC API-***(WDM) driver] and then click [Add and Remove Applications].

* "***" contains the driver category name (AIO, CNT, DIO, SMC, etc.).

< Uninstall the development environment >

Use [My Computer] - [Control Panel] - [Add and Remove Applications] to uninstall the development environment.

Select [CONTEC API-***(WDM) VerX.XX (development environment)] and then click [Add and Remove Applications].

* "***" contains the driver category name (AIO, CNT, DIO, SMC, etc.).

Uninstall procedure for Windows 98, 98SecondEdition

< Uninstall the device driver >

Use [My Computer] - [Control Panel] - [Add and Remove Applications] to uninstall the device driver. Select [CONTEC API-***(WDM) driver] and then click [Add and Remove Applications].

* "***" contains the driver category name (AIO, CNT, DIO, SMC, etc.).

< Uninstall the development environment >

Use [My Computer] - [Control Panel] - [Add and Remove Applications] to uninstall the development environment.

Select [CONTEC API-***(WDM) VerX.XX (development environment)] and then click [Add and Remove Applications].

* "***" contains the driver category name (AIO, CNT, DIO, SMC, etc.).

6. About Hardware

This chapter provides hardware specifications and hardware-related supplementary information.

Hardware specification

Table 6.1. Specification < I / 2 >

Item	Specification
Analog input	
Isolated specification	Unisolated
Type	Single-Ended Input
Number of input channels	4channels
Input range	(when 50Ω termination setting disabled) Bipolar ±10V, ±5V, ±2.5V, ±1.25V or Unipolar 0 - +10V, 0 - +5V, 0 - +2.5V (when 50Ω termination setting enabled) Bipolar ±5V, ±2.5V, ±1.25V or Unipolar 0 - +5V, 0 - +2.5V
Absolute max. input voltage *1	(when 50Ω termination setting disabled) When the power is ON ±13V (Max.) When the power is OFF ±13V (Max.) (when 50Ω termination setting enabled) When the power is ON ±7V (Max.) When the power is OFF ±7V (Max.)
Input impedance	1MΩ or more 50Ω±1%(when 50Ω termination setting enabled)
Resolution	12bit
Conversion accuracy *2*4	Within ±4LSB (input range : ±10V) Within ±6LSB (input range : 0 - +10V, ±5V) Within ±8LSB (input range : 0 - +5V, ±2.5V) Within ±10LSB (input range : 0 - +2.5V, ±1.25V)
Non-Linearity error *2*3*4	Within ±3LSB
Conversion speed	100nsec (Max.)
Passband (-3dB)	10MHz
Buffer memory	32M data
Conversion start trigger	Software, conversion data compare, external trigger, and event controller output.
Conversion stop trigger	Settings include data save complete, conversion data compare, external trigger, event controller output, and software.
External start signal	LVTTL level (Rising or falling edge can be selected by software)
External stop signal	LVTTL level (Rising or falling edge can be selected by software)
External clock signal	LVTTL level (Rising or falling edge can be selected by software)
External status output signal	LVTTL level Sampling clock output

*1: Do not input voltages in excess of the maximum input voltage. Similarly, do not input voltage exceeding 1.5 times the range being used, even if less than the maximum input voltage. Inputting too high a voltage may cause a fault.

*2: The rated precision may not be achieved depending on the cable used.

*3: The non-linearity error means an error of approximately 0.1% occurs over the maximum range at 0°C and 50°C ambient temperature.

*4: A R6161[ADVANTEST] voltage generator was used for measurements.

Table 6.1. Specification < 2 / 2 >

Item	Specification
Digital I/O	
Number of input channels	Unisolated input 4channels (LVTTTL level positive logic)
Number of output channels	Unisolated output 4channels (LVTTTL level positive logic)
Bus master section	
DMA channels	1channel
Transfer bus width	32bit
Transfer data length	8 PCI data length (Max.)
FIFO	1K data
Scatter/Gather function	64M-Byte
Synchronization bus section	
Control output signal	Selection of output signal with the software when specifying a sync master board.
Control input signal	Selection of sync factor with the software when specifying sync slave boards.
Max. board count for connection	16 boards including the master board
Connector (CN3, CN4)	PS-10PE-D4T1-B1 equivalent (mfd. By JAE) x 2
Common	
I/O address	64 ports x 1,256 ports x 1 region
Interrupt level	Errors and various factors. One interrupt request line as INTA
Connector used	For analog (CN1) : BNC connector DB-414K equivalent [mfd. By INSERT ENTERPRISE], or digital (CN2) : 16pin pin header connector
Current consumption	5VDC 2500mA (Max.)
Operating condition	0 - 50°C, 10 - 90%RH (No condensation)
Bus specification	32bit, 33MHz, Universal key shapes supported *5
Dimensions (mm)	176.41(L) x 106.68(H)
Weight	150g

*5: This product requires +5V power supply from expansion slots (it does not operate in the environment of only +3.3V power supply).

Board Dimensions

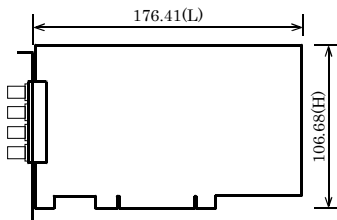

The standard outside dimension (L) is the distance from the end of the board to the outer surface of the slot cover.

Block Diagram

Figure 6.1 is a circuit block diagram of this product.

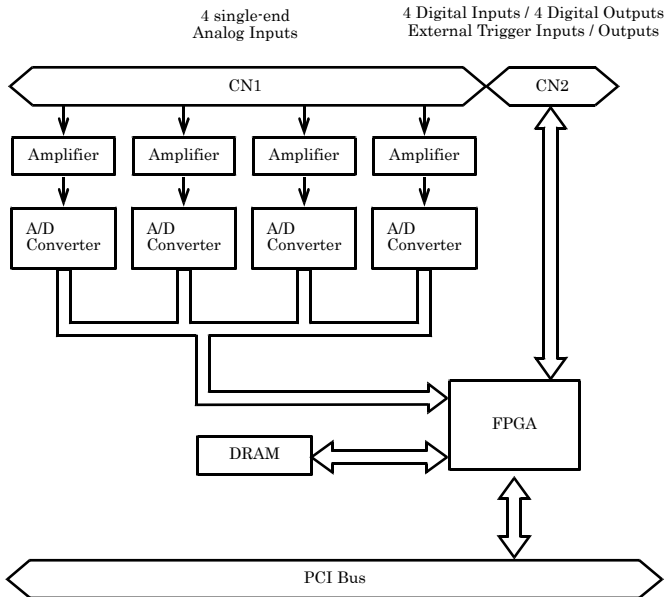

Figure 6.1. Block Diagram

Timing of Sampling Control Signals

Control Signal Timings for Analog Input

AI-1204Z-PCI is unrelated with the sampling clock, it is always sampled in each 100nsec. In a word, the conversion results from the A/D convertor are stored in an internal register once, the values are updated in each 100nsec.

The sampling clock controls the timing that the conversion results are stored from this register to an internal memory. Only the input data which is in memory can be acquired as effective data. Therefore, the following things are caused by a time position relationship between the sampling clock and 100nsec. When the sampling clock is input immediately after updating register, the error at time is not caused. However, when the sampling clock is input immediately before updating register, because the result which is updated by last time is stored in the internal register, the error between the sampling clock and the sampled timing is 100nsec or less.

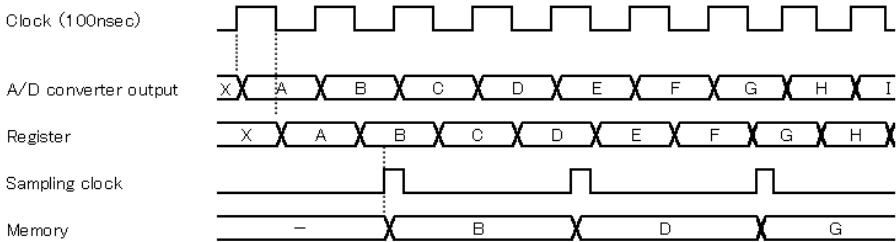

Figure 6.2. The sampling action is detailed

There are timing chart diagrams and a table about sampling control signals as shown Fig.6.3 - 6.5 and Table 6.2.

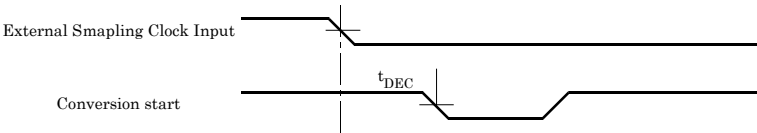

Figure 6.3. Timing Chart of External Sampling Clock

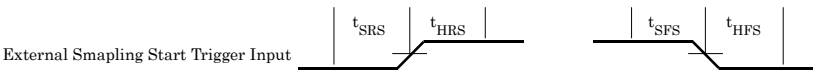

Figure 6.4. Timing Chart of External Sampling Start Trigger

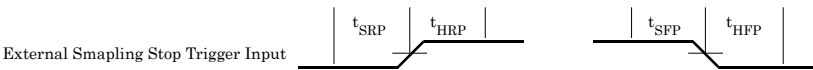

Figure 6.5. Timing Chart of External Sampling Stop Trigger

Table 6.2. Timing Table of External Control Signals

Parameter	Symbol	Time	Unit
Delay time from external sampling clock to data latch of the A/D converting data register	tDEC	40	nsec
Set up time of sampling start (Rising edge)	tsRS	50	nsec
Hold time of sampling start (Rising edge)	thRS	50	nsec
Set up time of sampling start (Falling edge)	tsFS	50	nsec
Hold time of sampling start (Falling edge)	thFS	50	nsec
Set up time of sampling stop (Rising edge)	tsRP	50	nsec
Hold time of sampling stop (Rising edge)	thRP	50	nsec
Set up time of sampling stop (Falling edge)	tsFP	50	nsec
Hold time of sampling stop (Falling edge)	thFP	50	nsec

**CAUTION**

All the model values are shown at the time of Table 6.2.

About Calibration

Although this product is calibrated before shipping, you can use the calibration program to calibrate analog input and output yourself.

Starting the calibration program

Click the [Calibration] button on the property page for the device to start the calibration program.

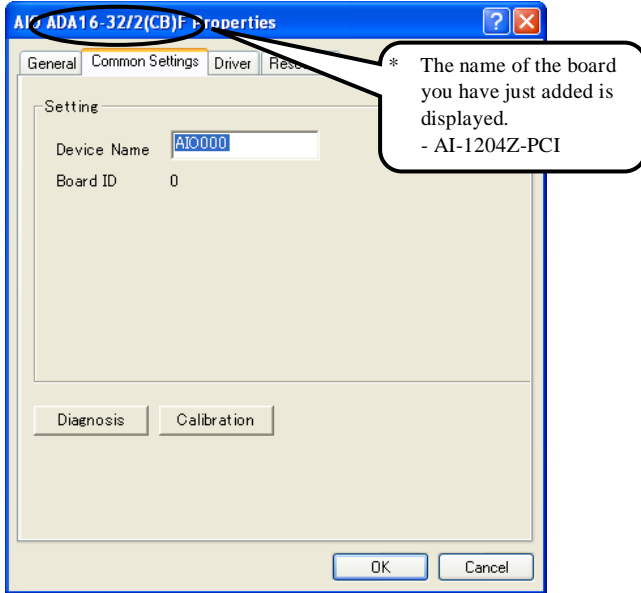

Proceed with connecting the calibration equipment and performing the calibration in accordance with the instructions displayed by the calibration program.

Analog input calibration

Analog input calibration requires a reference voltage generator.

As the analog inputs have 12bit resolution, use a device that is precise to four digits after the decimal point.

Calibrate for each range and channel that you intend to use.

* This product's calibration function may not be able to compensate when using the 50Ω termination resistor due to the voltage divider effect with the resistance of the cable.

Factory setting

You can use the calibration program to restore the factory calibration settings.

Contact your retailer if this product does not provide its prescribed performance.

AI-1204Z-PCI

User's Guide

CONTEC CO., LTD.

December 2017 Edition

3-9-31, Himesato, Nishiyodogawa-ku, Osaka 555-0025, Japan
<https://www.contec.com/>

No part of this document may be copied or reproduced in any form by any means without prior written consent of CONTEC CO., LTD. [12152017]

[12112007]

Management No. A-51-407

[12152017_rev6]

Parts No. LYHD506