

PC-HELPER

Isolated Analog Output Module for USB

DAI12-4(USB)GY

User's Guide

CONTEC CO.,LTD.

Copyright

Copyright 2002 CONTEC CO., LTD. ALL RIGHTS RESERVED

No part of this document may be copied or reproduced in any form by any means without prior written consent of CONTEC CO., LTD.

CONTEC CO., LTD. makes no commitment to update or keep current the information contained in this document.

The information in this document is subject to change without notice.

All relevant issues have been considered in the preparation of this document. Should you notice an omission or any questionable item in this document, please feel free to notify CONTEC CO., LTD.

Regardless of the foregoing statement, CONTEC assumes no responsibility for any errors that may appear in this document nor for results obtained by the user as a result of using this product.

Trademarks

All company and product names that are referred to in this manual are generally trademarks or registered trade.

Product Configuration

- USB module (one of the following products)
[DAI12-4(USB)GY]...1
- CD-ROM [API-USBP(WDM)]...1
- Interface connector (plugs) FK-MC0,5/9-ST-2.5...2
- AC adapter (1.4m)...1
- USB cable (1.8m)...1
- Protective Rubber...4
- Magnet...2
- User's guide (this booklet)...1

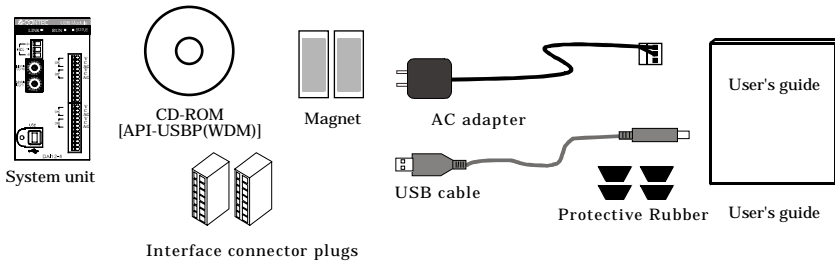

Check the contents to make sure that you have everything listed below. If you do not have all the items or have any damage, contact your distributor or CONTEC group office where you purchased.

Table of Contents

Copyright	i
Trademarks	i
Product Configuration.....	ii
1. Introduction.....	1
Summary	1
Features.....	2
Support Software	4
Accessories (Option).....	5
Customer Support	6
Web Site.....	6
Limited One-Year Warranty	6
How to Obtain Service	7
Liability	7
Use with Safety	7
Notice icon for safety information	7
Operation Precautions	8
Environment	9
Inspection	9
Storage.....	9
2. Module Nomenclature.....	11
3. Setup	13
Connection-Overall Diagram.....	13
Setting a Module ID.....	14
Setup Flow.....	15
Connecting to a PC.....	15
Setting Properties Using Device Manager.....	18
Software Installation	20
Illustration of Menu Screen.....	20
Installation of API-USBP(WDM) Development Environment	21
Connecting to an External Device	22
Signal Layout	22
Connection Method	23
Sampling.....	28

Settling Time	30
Installing the Module	32
Mounting on a DIN Rail	32
Mounting with magnets	36
Installation Orientation	37
Using Several Modules with the same Model.....	38
Setting a Module ID	38
4. Application Development.....	39
Reference to Online Help.....	39
Printing Function Reference	39
Sample Program	40
Distributing Developed Application.....	40
5. Troubleshooting	41
Troubleshooting	41
Q & A.....	42
Diagnostic Program	44
Version Upgrade	45
How to Upgrade the Firmware	45
Returning to Initial State.....	47
6. Connecting with Expansion Accessories	49
Setting a Device ID.....	51
Connection between Modules.....	52
Stack Connection Locking Devices	52
How the Stack Connection Locking Device Works...	53
Connecting the Module.....	54
Removing the Module.....	55
7. Product Specification.....	57
Hardware Specification	57
Software Specification	58
Circuit Block Diagram.....	59
Timing Chart.....	60
External Dimensions	61
8. Appendix.....	63
Glossary.....	63

1. Introduction

Summary

Before, the measurement and control was realized by way of inserting PCI interface boards into expansion slots of a desktop computer in case of configuring system using computers. However, because of the limit on number of expansion slots, it is difficult to configure system sometimes, or it is difficult to perform the same measure and control as PCI interface boards for a note PC. The USB module can be used to resolve that kind of problems.

DAI12-4(USB)GY is compact analog output module which is applied to USB and can be used easily.

DAI12-4(USB)GY is a DA conversion module, its output channels and resolution are 4ch and 12 bits respectively.

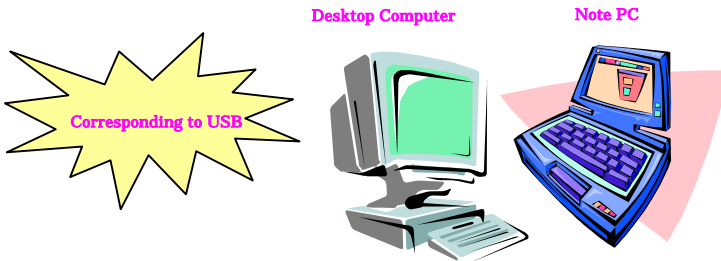

It can be used by PC with USB interface and is for note PC best.

When using it on a desktop computer, you can perform simple connection without the need for opening the host cover.



Being connected with USB port, the USB module can be setup simply.

The communication in Full Speed (12Mbps) is added to this USB module, and which is compatible with High Speed (480Mbps). High Speed is namely High-Speed data communication which is additional definition in the specification of USB2.0. The host controller performs communication in 480Mbps when corresponding to High Speed of USB2.0. Comparing with communication in Full Speed, the response for module access as communication in High Speed improves.

Features

Storing 256K data

DAI12-4(USB)GY can store up to 256K conversion data. Because of stored data beforehand, the optional cyclic wave can be easily output. The executable, minimum sampling cycle depends for an executable output cycle to sample in the module and to process at time of the output processing in the module, and becomes about 1msec(Use it 32 channels) at 400 μ sec (Use it 1 channel).

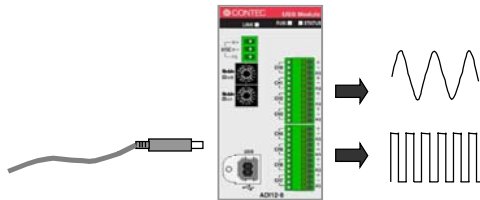

Isolated form external device

There is not external electric effect on the host computer by way of USB ports because of the isolation between the CPU of the module and external device by opto-coupler.

Setting range with software

You can select the range from 0 -10V, 0 - 5V, \pm 10V, \pm 5V, 0 - 20mA.

Easy to wire

The system incorporates a screwless connector plug that allows you to easily attach and detach wires without using any special tools.

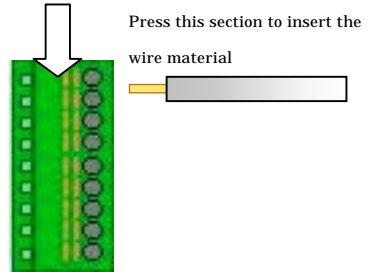

Easy-to-install design

The system, in the module itself, incorporates a 35mm DIN rail mounting mechanism as a standard item, so it can be attached and detached easily.

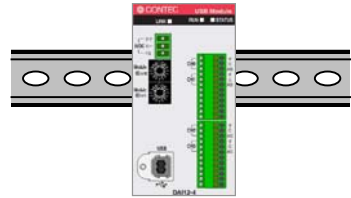

Easy to extend output channel

By adding expansion modules sold separately, the number of output channels can be increased.

It adopts the unique configuration of stack connecting which permits a simple, smart system configuration.

- DAI12-4(USB)GY + DAI12-4(FIT)GY × 3
(Up to 16 channels can be extended)

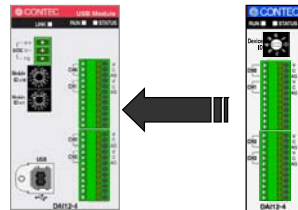

Easy-to-develop-application sample program

Visual Basic, Visual C++, Delphi and C++ Builder sample programs have been prepared. Functions convenient for developing generic applications, such as the functions that acquire the list of the current available USB modules, are prepared.



Diagnostic program

When the problem occurred, it will be helpful to solving the problem.

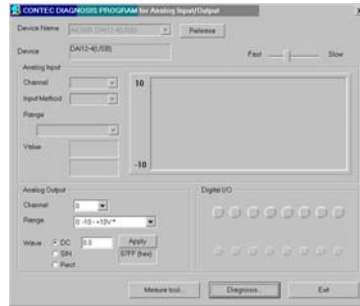

Support Software

It is suggested that support software produced by our company should be used according to the goal and development environment.

Driver Library API-USBP(WDM) (Bundled)

It is the library software, and which supplies command of hardware produced by our company in the form of standard Win32 API function (DLL). Using programming languages supporting Win32API functions, such as Visual Basic and Visual C++ etc., you can develop high-speed application software with feature of hardware produced by our company.

In addition, you can verify the operation of hardware using Diagnostic programs.

CONTEC provides download services (at <http://www.contec.com/apiusbp/>) to supply the updated drivers and differential files.

For details, read Help on the bundled CD-ROM or visit the CONTEC's Web site.

< Operating environment >

Primary corresponding OS: Windows XP, 2000, Me, 98, etc..
Primary corresponding language: Visual C++ .NET, Visual C# .NET, Visual Basic .NET, Visual C++, Visual Basic, Delphi, C++Builder, etc..

Accessories (Option)

Isolated analog output module: DAI12-4(FIT)GY
(Expansion module for DAI12-4(USB)GY)

AC adapter

(input: 90 - 264VAC, output: 5VDC 2.0A) : POA-AD22

AC-DC power supply unit

(input: 85 - 132VAC, output: 5VDC 3.0A) : POW-AC13GY

AC-DC power supply unit

(input: 85 - 264VAC, output: 5VDC 2.0A) : POW-AD22GY

AC-DC power supply unit

(input: 85 - 264VAC , output: 5VDC 4.6A(230VAC),
4.2A(115VAC)) : POW-AD25GY

DC-DC power supply unit

(input: 10 - 30VDC, output: 5VDC 3.0A) : POW-DD10GY

Check the CONTEC's Web site for more information on this product.

Customer Support

CONTEC provides the following support services for you to use CONTEC products more efficiently and comfortably.

Web Site

Japanese	http://www.contec.co.jp/
English	http://www.contec.com/
Chinese	http://www.contec.com.cn/

The latest product information

CONTEC provides up-to-date information on products. CONTEC also provides product manuals and various technical documents in the PDF.

Free download

You can download updated driver software and differential files as well as sample programs available in several languages.

Note! For product information

Contact your retailer if you have any technical question about a CONTEC product or need its price, delivery time, or estimate information.

Limited One-Year Warranty

CONTEC Interface boards are warranted by CONTEC CO., LTD. to be free from defects in material and workmanship for up to one year from the date of purchase by the original purchaser.

Repair will be free of charge only when this device is returned freight prepaid with a copy of the original invoice and a Return Merchandise Authorization to the distributor or the CONTEC group office, from which it was purchased.

This warranty is not applicable for scratches or normal wear, but only for the electronic circuitry and original boards. The warranty is not applicable if the device has been tampered with or damaged through abuse, mistreatment, neglect, or unreasonable use, or if the original invoice is not included, in which case repairs will be considered beyond the warranty policy.

How to Obtain Service

For replacement or repair, return the device freight prepaid, with a copy of the original invoice. Please obtain a Return Merchandise Authorization Number (RMA) from the CONTEC group office where you purchased before returning any product.

*** No product will be accepted by CONTEC group without the RMA number.**

Liability

The obligation of the warrantor is solely to repair or replace the product. In no event will the warrantor be liable for any incidental or consequential damages due to such defect or consequences that arise from inexperienced usage, misuse, or malfunction of this device.

Use with Safety

Please use this product with safety on the basis of understanding following content.

Notice icon for safety information

In order to prevent personal accident and damage to the machine, safety information is supplied in this manual by following symbols. Please operate the machine with safety on the basis of understanding its content.

⚠ DANGER	DANGER indicates an imminently hazardous situation which, if not avoided, will result in death or serious injury.
⚠ WARNING	WARNING indicates a potentially hazardous situation which, if not avoided, could result in death or serious injury.
⚠ CAUTION	CAUTION indicates a potentially hazardous situation which, if not avoided, may result in minor or moderate injury or in property damage.

Operation Precautions

DANGER

Please do not use the product in environments subject to flammable and corrosive gas. Otherwise, it can bring on exploding, fire, electric shock and trouble.

CAUTION

- There are switches on the module that need to be set in advance. Be sure to check its switch settings before using the module.
 - Please do not change the module switch settings in an unauthorized manner. Otherwise, it can bring about malfunction, heating and trouble.
 - Please do not subject the module to impact or bend it. Otherwise, it can bring about malfunction, heating, trouble and damage.
 - Please do not touch the metallic pins on the external module connector. Otherwise, it can bring about malfunction, heating and trouble.
 - Please do not connect expansion module when the power for the module is turned on. Otherwise, it can bring about malfunction, heating and trouble. Be sure to turn off the power for the USB module.
 - Please do not touch the module with a wet hand when the power for the module is turned on. It is danger of electric shock. Be sure to turn off the power for the USB module.
 - If you notice any strange odor or overheating, please unplug the power cord and USB cable immediately. Otherwise, it can bring about malfunction, heating and trouble. In the event of an abnormal condition or malfunction, please consult the dealer from whom the product was purchased.
 - In order to add functions to the product and perform quality improvement, the product specification is subject to change without notice. Even if you use the product again, please be sure to read the manual to confirm the content.
 - Please do not modify the product. CONTEC will bear no responsibility for any problems, etc., resulting from modifying the product.
 - Please do not open the product casing. CONTEC will disclaim any responsibility for products whose casing has been opened.
 - Regardless of the foregoing statement, CONTEC assumes no responsibility for any errors that may appear in this document nor for results obtained by the user as a result of using this product.
-

Environment

Please use this product in the environment as follows. It can bring about heating, malfunction and trouble when the product is used in unauthorized environment.

Environment temperature

0 - 50°C

Environment humidity

10 - 90%RH (No condensation)

Corrosive gases

None

Floating dust particles

Not to be excessive

Inspection

Please regularly perform inspection so as to use the product with safety.

*The ventilation slits are not covered, and neither dust nor alien substance is attached to the ventilation slits

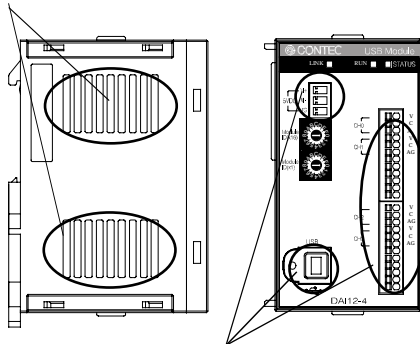

*Make sure that the connectors on the module side are correctly connected with the cables

Storage

Please store the product according to the state in which you purchased.

- (1) Store the module into a storage bag.
- (2) Store the module into a box with wrapper.
- (3) Please store the module in normal temperature avoiding direct sunlight, shock and vibration, magnetic field and static electricity.

2. Module Nomenclature

Figure 2.1 shows the names of module components. In the figures, the indicated switch settings represent factory settings.

DAI12-4(USB)GY

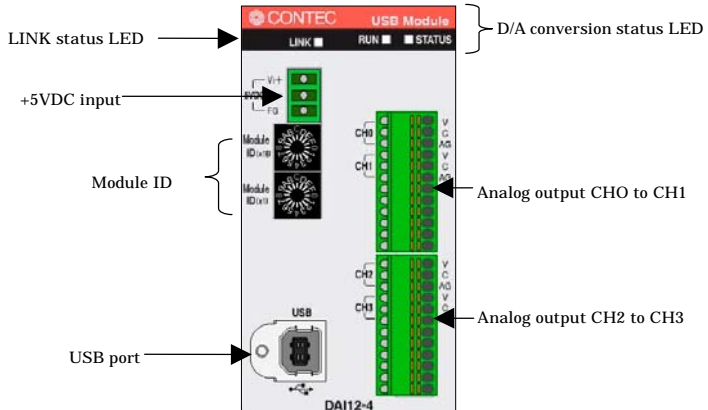

Figure 2.1. Nomenclature of Module Components
< DAI12-4(USB)GY >

Table 2.1. The List of Status LED Functions
< DAI12-4(USB)GY >

Name	Function	Indicator color	LED indicator
LINK status	USB communication status	GREEN	ON: Communication established
			OFF: Communication unestablished
RUN LED	Operation status of the module	GREEN	ON: Operation enabled
			OFF: Operation disabled
STATUS LED	D/A conversion error indicator	RED	ON: D/A conversion error
			OFF: Normal D/A conversion

3. Setup

Connection-Overall Diagram

This is connection-overall diagram. Please reference to this page for actual connection.

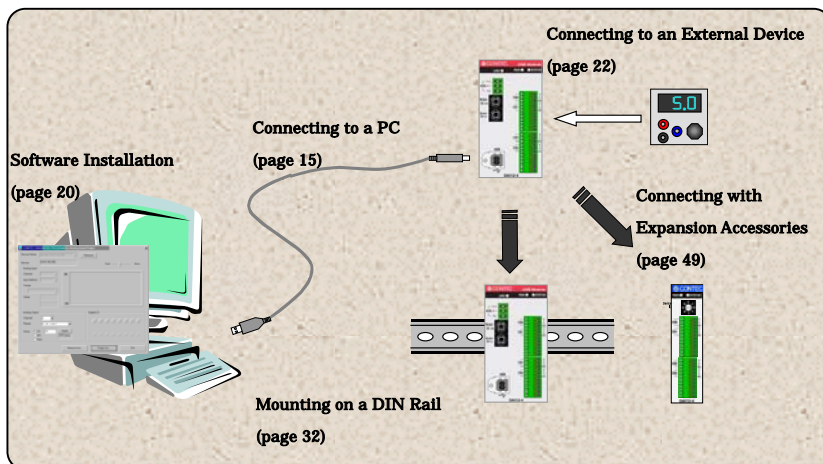

Figure 3.1. Connection-Overall Diagram

Setting a Module ID

The host computer distinguishes and keeps track of the modules of same model by assigning Module IDs to them. Factory settings “00” can be used when only one module per model is connected to one computer.

Each module should be assigned a unique Module ID in the range of 00 - 7Fh when several modules with the same model are being connected.

There are two rotary switches, moreover, “x16” and “x1” represent high bits and low bits of Module ID respectively.

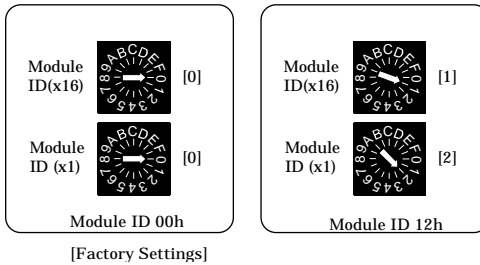
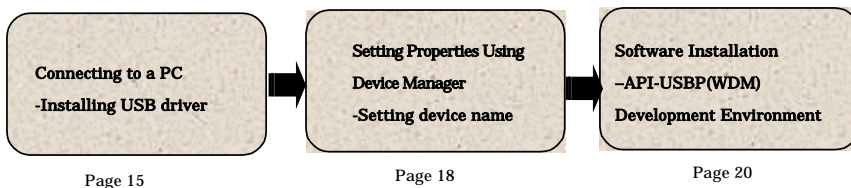

Figure 3.2. Setting a Module ID

Setup Flow

The following shows the basic flow for installing USB module.



Connecting to a PC

Connect the USB device to a PC and install the driver.

It is illustrated by taking example for Windows Me. Displaying screen may be different according to different OS, but basic settings are the same.

Points

- You must be logged on as an administrator or a member of the Administrators group to work on Windows 2000 or Windows XP.
- The name detected by Windows and displayed by software is the model removing the “GY”.

Step1 Setting Supplied CD-ROM “API-USBP(WDM)”

The menu screen is displayed. The menu will be used in “Software Installation” on page 20. (If the menu screen is not displayed for PC settings, please jump to Step2.)

Step2 Connecting USB port with a PC

Connect the supplied AC adapter or power supply unit (option) to supply power to the USB device. Use the supplied USB cable to connect the USB port on the USB module to the USB port on the PC. Ensure that the connector is aligned correctly with the socket and push all the way in.

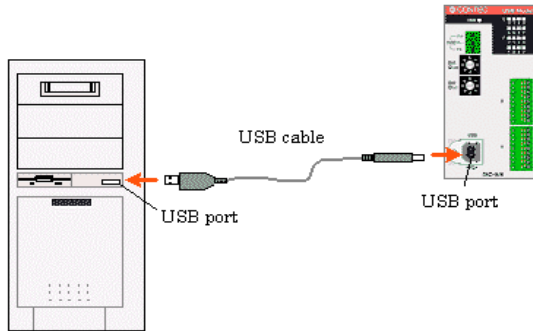

Note!

Always use the supplied AC adapter or power supply unit (option).

Step3 Starting “Add New Hardware Wizard”

Start “Add New Hardware Wizard”, then select “Detect Proper Driver Automatically” item and finally click on “Next Step” button.

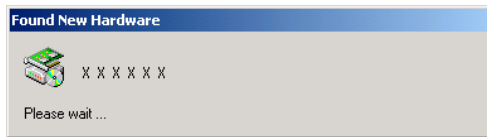

Detect setup information from supplied CD automatically for installing USB driver. XXXXXX: device name being searched out(the name from getting rid of GY from the model)



Point

Please specify the path for supplied CD as follows in the case of failure in detecting automatically.
X:\INF\WDM\AIO (X: CD-ROM drive)

Step4 Clicking on [Finish] button

Click on [Finish] button to complete the installation of USB driver.



Setting Properties Using Device Manager

After connecting USB module with a PC and completing driver installation, open device manager and set properties.

Step1 Starting Device Manager

Right-click on [My Computer] and select [Properties] to start device manager.

[XXXXXX] within CONTEC Devices expresses the name from getting rid of GY from the model of USB module.

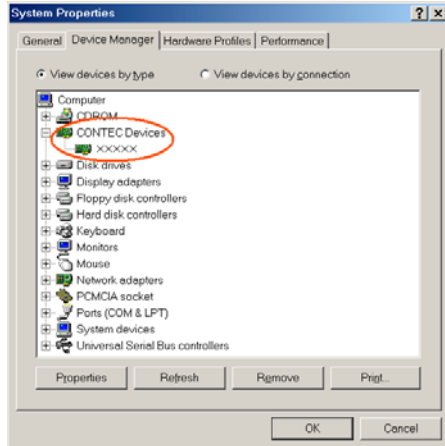

In the case of Windows XP/2000

From [Start] menu, click on [Settings]-[Control Panel]-[System] and then click on [Device Manager] button in [Hardware] tab.

Step2 Setting the Device Name

Right-clicking on USB module name and selecting [Properties] displays [USB Module Properties]. Open [Common Settings] tab and enter arbitrary name in the editing box for device name. (Default name also can be used.)

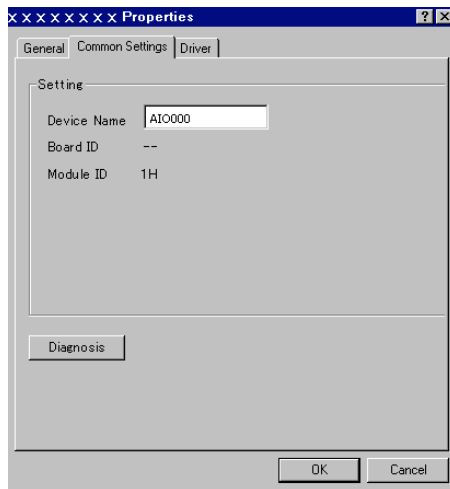

CAUTION

USB driver can not be used without settings. Settings must be performed.

Step3 Clicking on [OK] button

Device name is set by clicking [OK] button.

Points

- When the application developed by users is running on an other PC, please perform foregoing operation on the target computer. (no need to install software introduced on next page)
- Please use the device name specified in last step for initialization function when initialization is performed using API function. When running on other PC, it can run without changing the application for the same device name being specified.

Software Installation

Connect with USB module, and install following software if USB driver has been installed.

Illustration of Menu Screen

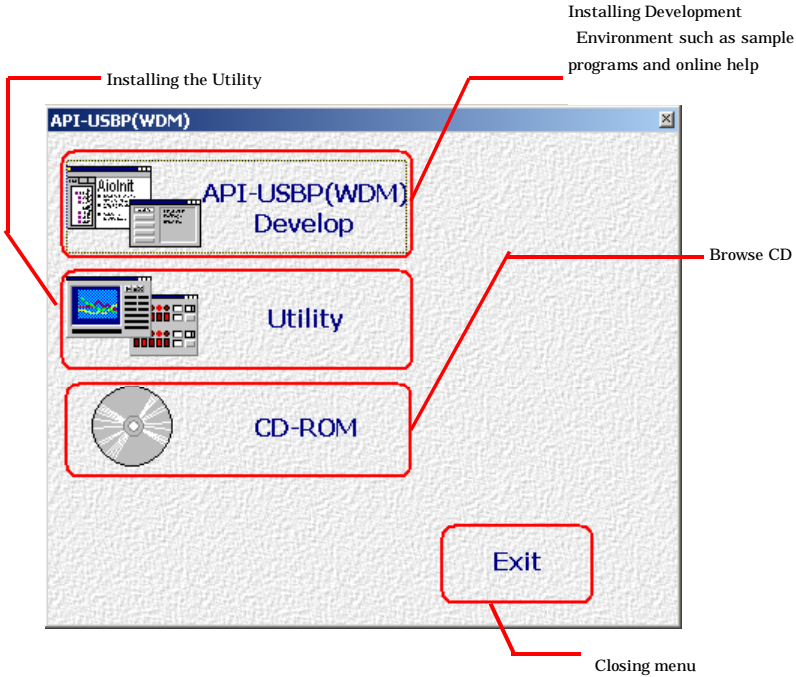

Points

- Please set up the supplied CD-ROM if it has not been set up. The menu starts automatically.
- If the menu do not start, launch X: AUTORUN.EXE (X: CD-ROM drive) from [Run...] in Start menu.
- The screen design may be different.

Installation of API-USBP(WDM) Development Environment

Installation of development environment is namely installing supplied online help and sample program in all language in order to use API function.

Step1 Clicking on “API-USBP(WDM) Develop”

[Installing the development environment] dialog box displays.

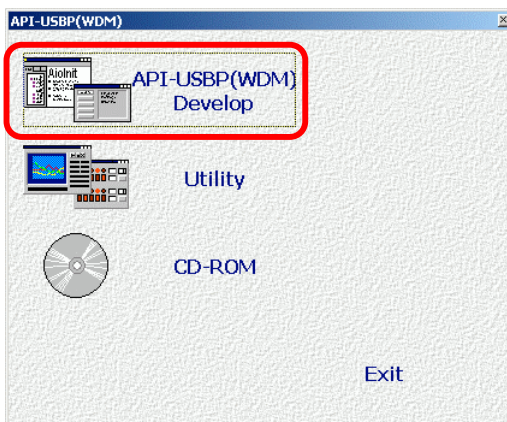

Step2 Selecting ”Analog I/O”

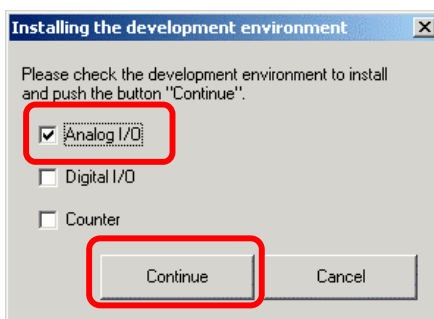

Step3 Clicking on “Continue” button

Please perform installation following the directions on the screen. And thus the installation is completed.

The screen design may be different.

Connecting to an External Device

Signal Layout

The Module can be connected to an external device using a 12-pin connector that is provided on the Module face.

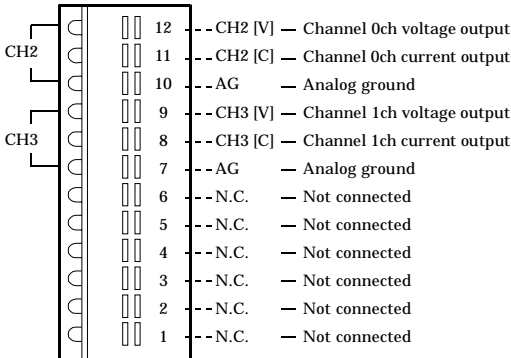
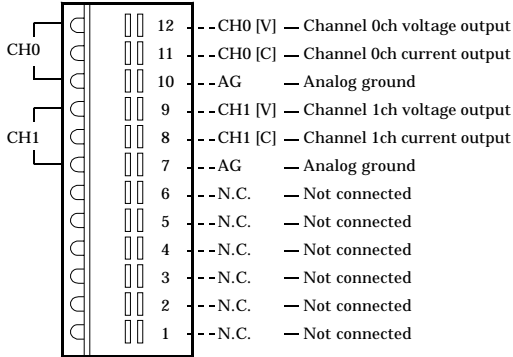

**Figure 3.3. Signal Layout on the Interface Connector
< DAI12-4(USB)GY >**

Connection Method

When connecting the module to an external device, you can use the supplied connector plug. When wiring the module, strip off approximately 7 - 8 mm of the covering for the cable, and insert the bare wire by pressing the orange button on the connector plug. Releasing the orange button after the wire is inserted fixes the cable. Compatible wires are AWG 28 - 20.

⚠ CAUTION

Removing the connector plug by grasping the cable can break the wire.

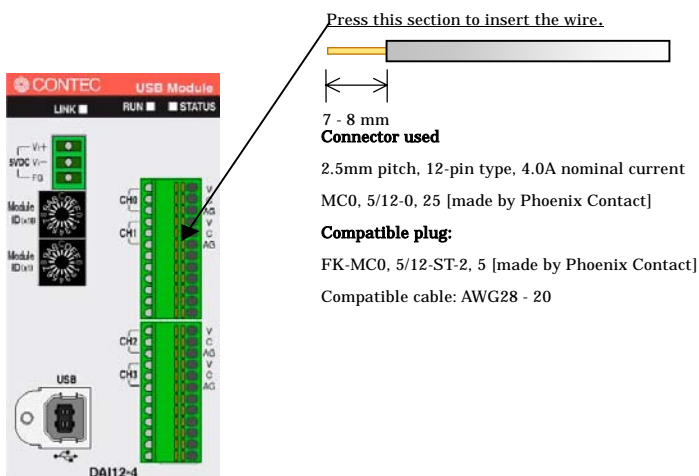
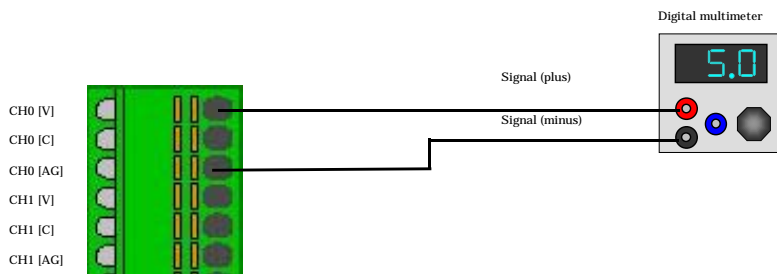

Figure 3.4. Connecting an Interface Connector and Connectors That Can Be Used

Input voltage output to an external device

Connecting digital multimeter with flat cable.



A coaxial cable can be used in situations where the module is at a relatively large distance from the external device or when the noise immunity of the module must be improved. In this case, the voltage output and the analog ground for each channel are connected to the input and the ground, respectively, of the external device by using the core wire and the shield braid of the coaxial cable.

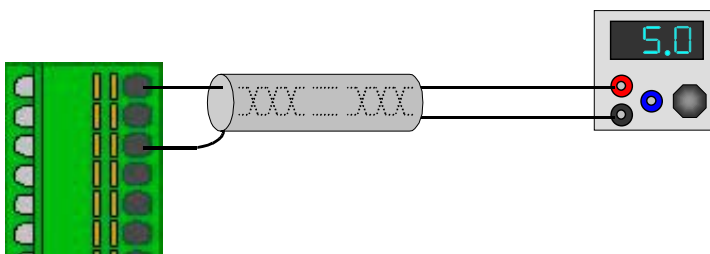

⚠ CAUTION

- When the power is turned on or the USB cable is plugged, the voltage output signal will be 0V.
 - To avoid any malfunction, the voltage output signal should not be connected to the analog ground.
 - To avoid any malfunction, the voltage output signal should not be connected to another analog ground signal or the output signal of external device.
 - To avoid any malfunction, the connector plug should not be attached or detached when the power for the module or the external device is on.
 - The maximum current capacity for a voltage output signal is $\pm 5\text{mA}$. To avoid any malfunction, do not connect an external device that generates a load exceeding this range.
 - In situations where the connecting cable is subject to the effects of noise, the accurate voltage output can fail. The connecting cable should be installed away from any source of noise.
 - In situations where the connecting cable is excessively long, the accurate voltage output can fail. Use a cable that is as short as possible.
 - Because the D/A converter in the module does not contain a built-in deglitcher, a glitch can sometimes occur.
-

Controlling external device by current loop

Load that can be controlled by current loop have two sorts, floating load and fixed load. If the module is used as a floating load, multiple current loops can be implemented by using the same power supply. The use of current output requires an external power supply (10 - 24V). In such a case, a power supply with a small ripple should be used in order to avoid an adverse impact on the conversion accuracy due to a large power supply ripple.

Moreover, the load resistance R_L that is connected to the current output of each channel should be less than 500Ω , including the wire resistance.

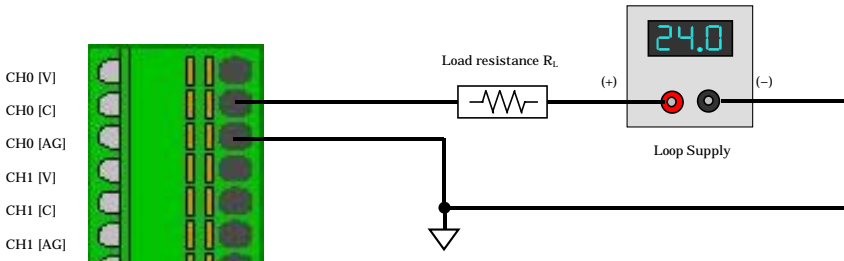

Figure 3.5. Connecting to a Floating Load

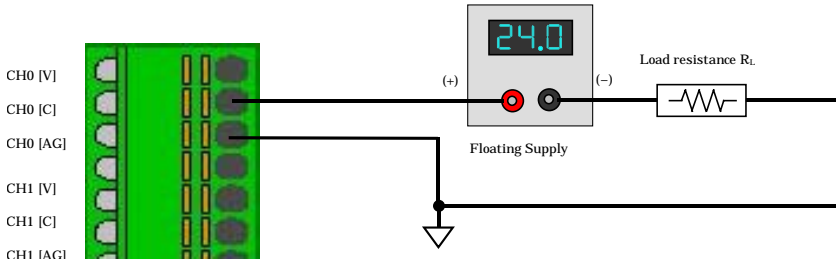

Figure 3.6. Connecting to a Fixed Load

⚠ CAUTION

- When the power is turned on or the module is reset, the current output signal will be 0mA.
 - To avoid any malfunction, the current output signal should not be connected to the analog ground.
 - To avoid any malfunction, the current output signal should not be connected to another analog output signal or the output signal of an external device.
 - To avoid any malfunction, the connector plug should not be attached or detached when the power for the module or the external device is on.
 - In situations where the connecting cable is subject to the effects of noise, the accurate current output can fail. The connecting cable should be installed away from any source of noise.
-

Sampling

On DAI12-4(USB)GY , the range of output can be selected from 0 - 5V, 0 - 10V, $\pm 5V$, $\pm 10V$, 0 - 20mA by using software. The digital signals are converted into analog output signals at a 12-bit resolution level based on the range setting.

Unipolar range

Indicates that the range of controlled voltage is single polar range, for this module, it is 0 - 5V or 0 - 10V. The right figure shows the relation between conversion data and voltage value within the range of 0 - 10V. The right figure shows the relation between converted data and voltage value within the range of 0 - 10V. Because the converted data is based on the value of dividing 10V voltage width (voltage span) by 4096, the converted data increases every 1, the voltage value increases 2.44mV.

Moreover, the conversion data increases every 1, each voltage value increases 1.22mV in case of 0 - 5V range. Because of the same definition within the range of 0 - 20mA, the conversion data increases every 1, the current value increases 0.00488mA.

Voltage value [current value] = voltage span [current span] of the output range / 4096 * (conversion data)

	(Decimal)	(Hexadecimal)	
10V	4095	FFFh	9.997 56 V
	4095	FFFh	9.997 56 V
	4094	FFEh	9.995 12 V
	4093	FFDh	9.992 68 V
	:	:	
	2049	801h	5.002 44 V
	2048	800h	5.000 00 V
	2047	7FFh	4.997 56 V
	:	:	
	2	002h	0.004 88 V
0V	1	001h	0.002 44 V
	0	000h	0.000 00 V

Bipolar range

Indicated that the range of controlled voltage is bipolar range, for this module, it is $\pm 5V$ or $\pm 10V$.

The right figure shows the relation between conversion data and voltage value within the range of $\pm 10V$. Because the converted data is based on the value of dividing 20V voltage width(voltage span) by 4096, the converted data increase every 1, the voltage value increase 4.88mV.

Moreover, the converted data increase every 1, the voltage value increase 2.44mV in case of $\pm 5V$ range.

Voltage value = voltage span of the output range / 4096 * (conversion data) + offset voltage

Offset voltage: -10V for range of $\pm 10V$ and -5V for range of $\pm 5V$

	(Decimal)	(Hexadecimal)	
10V	4095	FFFh	9.995 12 V
	4095	FFFh	9.995 12 V
	4094	FFEh	9.990 23 V
	4093	FFDh	9.985 35 V
	:	:	
	2049	801h	0.004 88 V
	2048	800h	0.000 00 V
	2047	7FFh	-0.004 88 V
	:	:	
	2	002h	-9.990 23 V
	1	001h	-9.995 12 V
-10V	0	000h	-10.000 00 V

Settling Time

D/A Conversion Timing

The settling time of DAI12-4(USB)GY is 10 μ sec at voltage-output 20 μ sec at current-output. Output data for 0 - 3 are converted analog signals simultaneously due to synchronization between channels in USB module.

Converting process time with internal CPU

DAI12-4(USB)GY converts the periodic output of D/A conversion with CPU which is inside of module.

The practicable minimum conversion period is about 400 μ sec at single channel mode through 1msec at multi-channel mode up to 16 channels, which is depends on the conversion processing time inside a module. If the set of internal clock time is shorter than internal converting processing time, sampling error will occur. Please refer to explanation of AioAoSetSamplingClock in online-help of an API function library.

When converting 0 channel

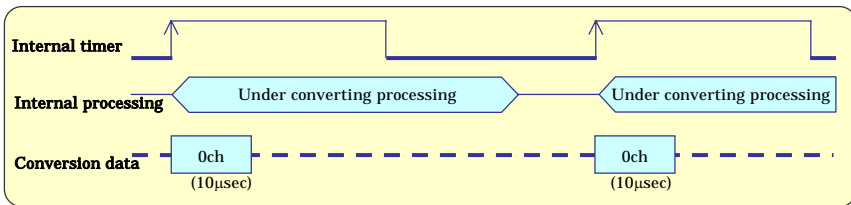

Outputting consecutive data

D/A conversion is able to store up to 256k-word to internal memory. The stored data that is transferred from host computer via USB is converted with cycle of internal clock. The share of memory is available, and the memory size per channel is up to 64k-word at 4-channel use. It is able to be D/A conversion over 256k-word if transferring D/A conversion data from host computer before the memory is empty.

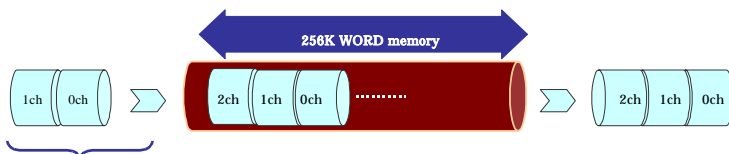

more than the number of transmitted data to module, the lack
of memory will be resulted in

⚠ CAUTION

Even if the DAI12-4(FIT)GY is used, the size of memory used for storing the conversion data has no change.

Installing the Module

Mounting on a DIN Rail

The following illustrates the installation with expansion module. Please reference to page 51 for expanding a module.

Installation method

- (1) Pushing the fixing hook with a flat-head screwdriver renders it into a lock-enabled condition (this should be done on all connected modules).

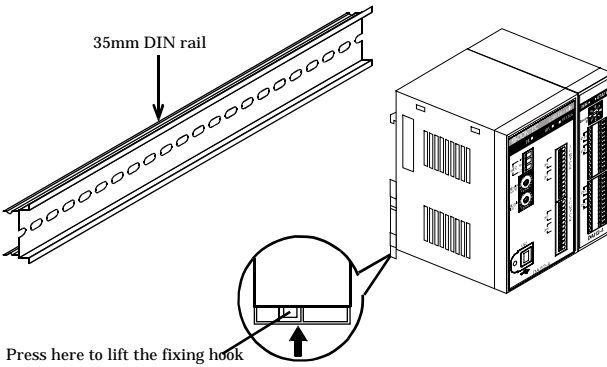

Figure 3.7. Mounting on a DIN Rail < 1 / 3 >

- (2) Hook the unit (an object consisting of a controller and a module) from the upper part of the DIN rail, and press the lower part of the unit onto the DIN rail.

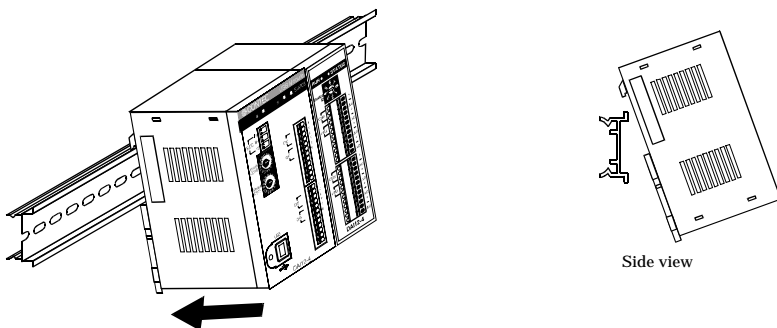

Figure 3.7. Mounting on a DIN Rail < 2 / 3 >

- (3) The fixing hook is automatically locked, and the module can be mounted in one-touch.

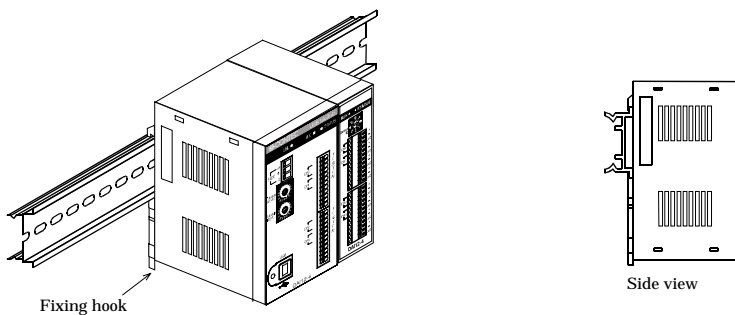

Figure 3.7. Mounting on a DIN Rail < 3 / 3 >

Removal method

- (1) Lower the fixing hook for the unit to unlock it (this operation should be performed on all connected modules).

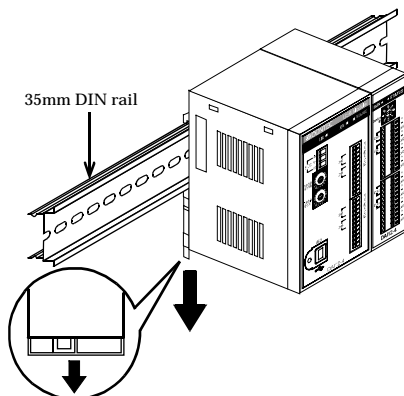

Figure 3.8. Removing the Module from the DIN Rail < 1 / 3 >

- (2) With the fixing hook unlocked, pull the lower part of the unit toward you.

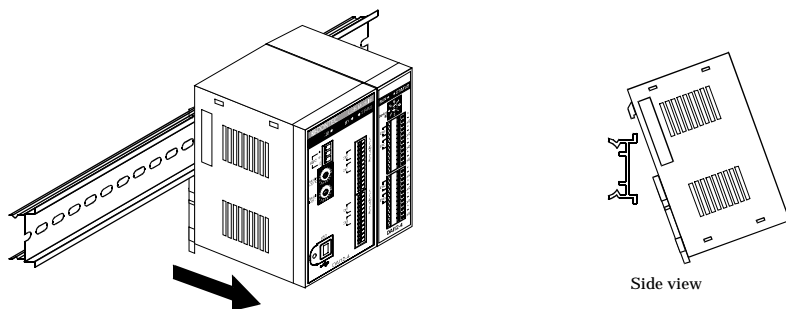

Figure 3.8. Removing the Module from the DIN Rail < 2 / 3 >

- (3) By lifting the unit, you can easily remove it from the DIN rail.

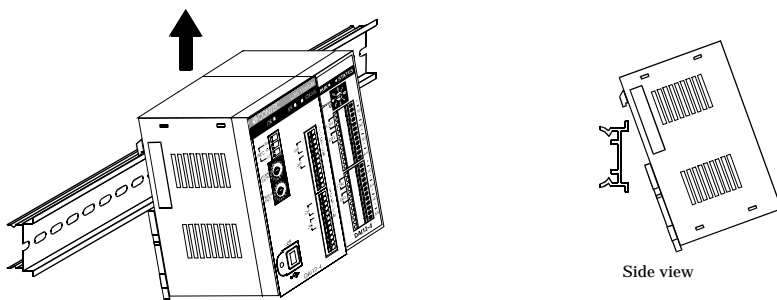

Figure 3.8. Removing the Module from the DIN Rail < 3 / 3 >

⚠ CAUTION

Any operation involving the disconnection of modules in a unit (in which multiple modules are connected) that is attached to a DIN rail should be performed after the unit is removed from the DIN rail.

Mounting with magnets

Two magnets are appended to this product. It is easy of attachment and removal of the module to metal sides, such as a desk, partition panel and so on.

Initial adhesion strength of seal is high, but adhesion strength decreases an ability of peeling strength if once removing a magnet from the enclosure of USB module.

The example of magneto-attachment

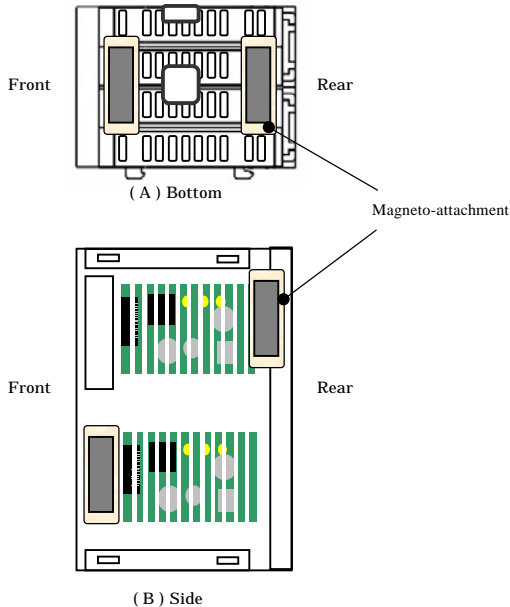

Notes!

- Please attach in a DIN rail on the wall and use USB Module, if connecting expansion modules.
- Please do not close ventilation holes due to prevention of the temperature rise inside a product. Otherwise, it can bring about malfunction, heating and trouble.

Installation Orientation

Please use the module following orientation illustrated in the graph when the module is mounting on a DIN rail and being used on a desk. It should be noted that lateral slit of the module being covered brings about malfunction.

In addition, please use the supplied two rubber feet when setting on a desk or others as figure 3.9(A).

Correct installation orientation

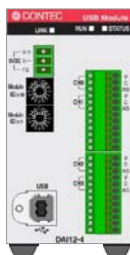

(A) Vertical, Front

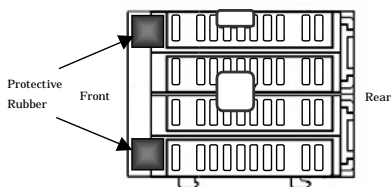

(B) Bottom

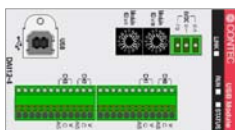

(C) Horizontal, Front

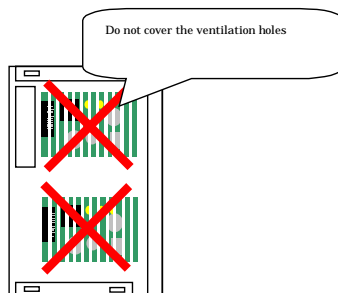

(D) Side

Figure 3.9. Installation Orientation

Using Several Modules with the same Model

Each module should be assigned a unique Module ID in order to let USB driver recognize them when several modules of the same model are being used.

Factory settings (=00) can be used when only one module is connected to one computer.

Unnecessary to set Module ID

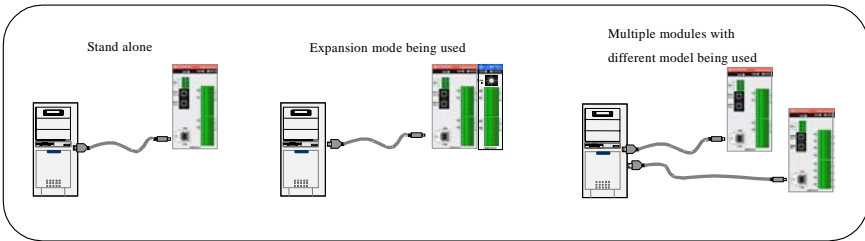

Necessary to set Module ID

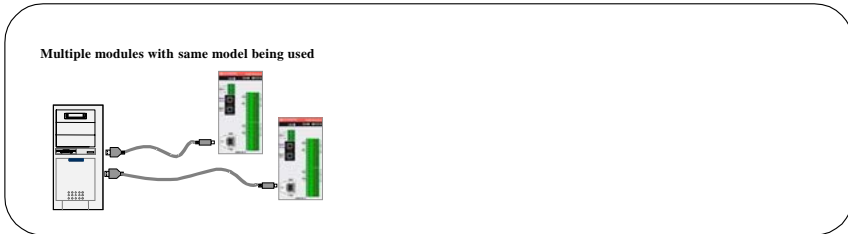

Setting a Module ID

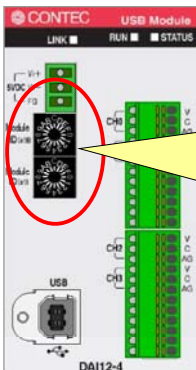

only one module being used,

factory settings(is 00)

multiple modules being used,

setting different value

4. Application Development

Please reference to online help and sample program when developing applications.

Reference to Online Help

Click on [Programs]-[CONTEC API-USBP(WDM)]-[API-USBP(WDM) Help] from [Start] menu.

The information for application development, such as function reference is provided in [API-USBP(WDM) Help].

Detailed introduction to search method for help should be found from [How to navigate Help] in the help.

For basic usage, please reference to “Tutorial” for help.

Printing Function Reference

Clicking on Print button from online help prints the page being displayed. It can be printed entirely as follows in the case of referencing to printing function. As figure shown on the right, selecting  mark and clicking on Print button prints all the topics under the mark selected at a time.

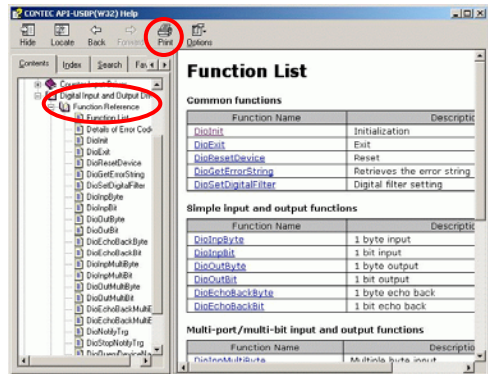

Sample Program

Sample programs are copied in installation path. (The default path is Program Files\CONTEC~) Sample programs in all language are provided here.

To run a sample program, click on [Programs]- [CONTEC API-USBP(WDM)]-[AIO]-[*Sample Name*] from [Start] menu.

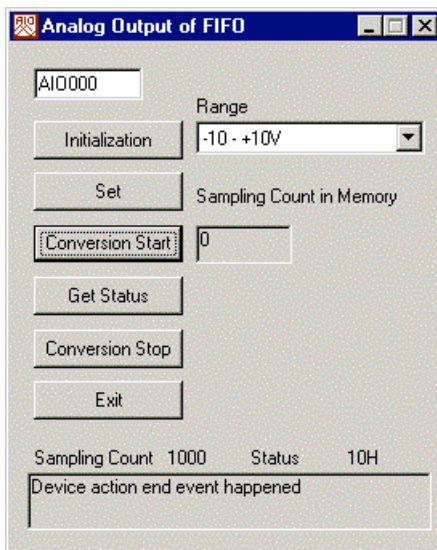

Distributing Developed Application

Please distribute the developed application with USB driver in supplied CD.

USB driver for Analog I/O

X:\INF\WDM\AIO (X: CD-ROM drive)

5. Troubleshooting

When encountering trouble or question, you should reference to this section first.

For the usage of [API Function Library], please reference to online help or the sample program.

Troubleshooting

Condition	Cause and measure
USB port of a PC is unusable.	There is no [Universal Serial Bus Controllers] in the category of [Control Panel]-[System]-[Device Manager]. It may be unusable for USB port without BIOS settings. BIOS settings is different according to different PC and so that you should reference to the manual of the PC being used.
"Unknown Device" is registered with device manager (Win98/Me).	The cause is incorrect operation such as canceling the wizard by mistake when connecting with a USB module. Follow the following procedure to delete unknown device. Start device manager, select [Unknown Device] and then click on [Delete] button.
"USB Device" is registered with device manager (Windows 2000).	The cause is incorrect operation such as canceling the wizard by mistake when connecting with a USB module. Follow the following procedure to delete unknown device. Start device manager, select [USB Device] and then right-click [Delete].
The menu can not be displayed when a PC CD-ROM is being set.	Select "Run..." form Start menu, and then type X: AUTORUN.EXE (X: CD ROM drive), finally, click on OK button.
The message of "HI-SPEED USB Device Plugged into non-HI-SPEED USB Hub" is displayed on Windows XP.	This USB module corresponds to communication with HighSpeed (480Mbps), and Full Speed (12Mbps) is used to communicate when host controller and HUT device do not correspond to HighSpeed. Warning message will be displayed on Windows XP and it does not disturb the operation.
Fail to output accurate data.	Please verify whether the output of each channel is correct by using diagnostic program.
Unknown reason for abnormal operation.	Please verify the content of error code in the help as error occurs from function. When program in developing is in no-operation, you should at first confirm whether the action of diagnostic program and sample program is normal. Contact with the support center if the problem has not been resolved. In this instance, please send back the result of diagnostic program and the result of sample program.

Q & A

Question	Answer
Can it run on Windows NT4.0 or Windows 95?	No. In addition, it can not run on Windows 3.1, Windows NT3.51 and so on.
Can it run on OS different from Windows?	It can not run on non-Windows OS such as Linux, MS-DOS etc.
Can you make an USB connection with PC-9821 series?	Not support.
How many USB modules can be connected to one PC?	The number for connection is namely the number of USB ports available on a PC. Please supply the power by AC adapter when expending ports by USB HUT.
Can the developed applications run on other PC?	Please install USB driver and set device name for developed applications with which the files necessary to distribute are supplied. USB driver is in the INF folder on CD-ROM drive.
Does it have license in distributing developed applications?	It is free to distribute developed applications.
Can applications be developed in language different from corresponding language?	The languages in which the supplied sample programs are written are the supported languages. USB driver is supplied in the form of Win32API DLL and so that it can be used by language and applications supporting this form (It can not be used by language which do not support corresponding argument type). The integrity of the operation cannot be guaranteed because we do not verify the operation.
Can it be used without programming knowledge?	There are supplied softwares (Development Environment) for application development on the CD-ROM. Applications are basically developed in corresponding language, and utility programs can be used to check status if you only want to monitor I/O status.
Can run with other applications together simultaneously?	It is possible because of multiple-thread processing in Windows. Reply from an application may be very slow because of the high load.
Can expansion modules with different type be connected?	No. In the case of using DAI12-4(USB)GY, DAI12-4(FIT)GY is the only module to be connected.
What about the maximum length of USB cable?	The maximum length is less than 5m according to USB specification. But it can expand to 6 tiers with 30m long when using USB HUT.

Question	Answer
How to get the version of USB driver?	Run diagnostic program and [Diagnosis...] to get the version of the driver.
How to upgrade USB driver to latest edition?	You can download it from following homepage when there is latest edition. http://www.contec.co.jp/en/
How to start the device manager?	Windows 2000: Start Start->Settings->Control Panel->System. Select Hardware and click on Device Manager.
Does it feature suspend/resume function?	No. It is unnecessary to connect with AC adapter when connecting with a HUT of self power. (It is necessary when using expansion modules.)
Want to perform the channels more than the channels being appended by expansion modules.	The number of expansion modules is 3(4 including the USB module). when channels more than this number are wanted, please purchase the necessary USB module(s) and expansion accessories.
Is adding channels by expansion modules different from adding USB modules?	When USB modules are added, the USB ports corresponding to those USB modules will be used. For example, channel 0 output of USB module A, channel 0 output of USB module B. When the expansion modules are added, they can be used in the image based on the number of points in the USB modules. For example, in the case of the number of output channels of USB module is n, channel 0 output of USB module A, channel 8 output of expansion module ~. Therefore, they can be treated as consecutive points.

Diagnostic Program

Running diagnostic program may identify that if abnormality exists in hardware or software.

Run diagnostic program, open Properties for USB module of device manager and then click on [Diagnosis] button in [Common Settings] tab.

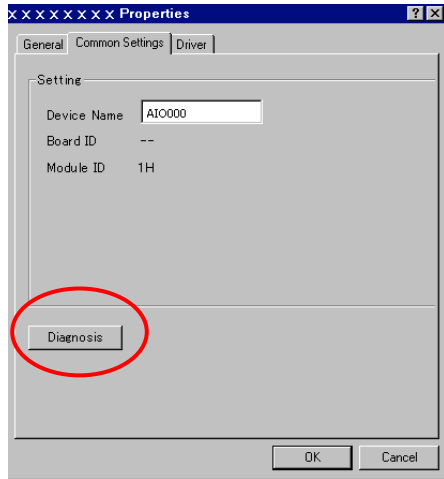

Using Diagnostic program, you can not only verify the status of current output but also perform further diagnosis by clicking on [Diagnosis...] button.

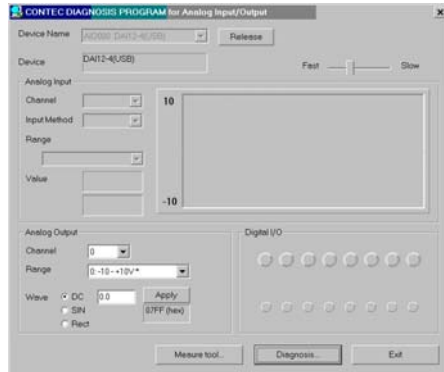

Version Upgrade

How to Upgrade the Firmware

Firmware is namely software which is embedded in USB module. Up-to-date firmware (update file) will be supplied in the homepage of our company in the case of function upgrade and so on.

The following presents how to update the update file downloaded from homepage to USB module.

Step1 Removing USB module

Please make disconnection when USB port is being connected. When using self power, remove AC adapter in order to reset status.

Step2 Set Module ID to FFh

Set Module ID to FFh.

It is special setting for firmware upgrade.

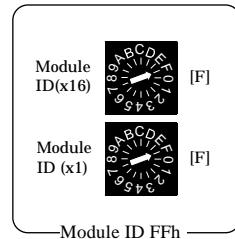

Point

Modules should be performed firmware version upgrade one by one.

Upgrade for multiple modules can not be performed at the same time.

Step3 Connecting USB module with USB port

Please connect USB port after AC adapter has been connected when using self power.

Step4 Starting firmware upgrade tools

Click on [Programs]-[CONTEC API-USBP(WDM)]-[Firmware upgrade tool] from [Start] menu.

Step5 Specifying upgrade file

Clicking on [Browse] button specifies the file which has been downloaded.

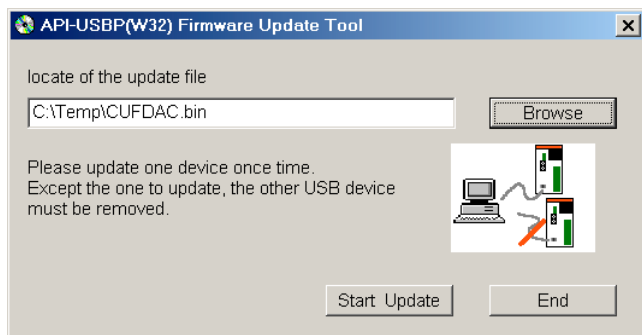

Step6 Clicking [Start Upgrade] button

Upgrade is completed automatically.

Step7 Setting properties using Device Manager once more

After completing upgrade, perform settings again by referencing to “Setting Properties Using Device Manager” on page 20.

Driver Upgrade

If there is up-to-date driver, it is supplied in the homepage of our company.

<http://www.contec.com/>

Returning to Initial State

This is the method of returning to initial state. It is suggested that you should return to initial state and perform installation again when the operation is losing stabilization.

Step1 Deleting device form Device Manager

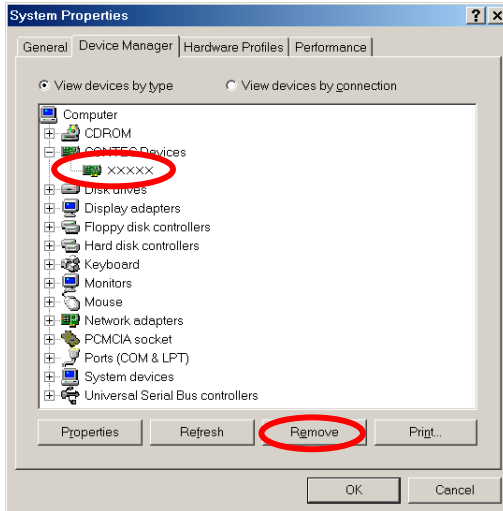

Step2 Drawing USB cable from a PC

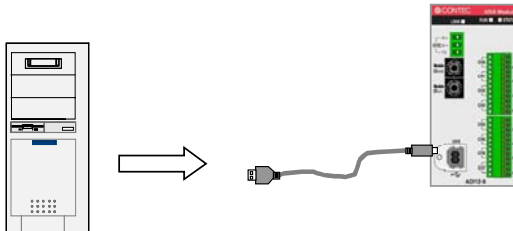

Step3 Uninstalling driver

Select [CONTEC API-AIO(WDM) driver] from [My Computer]-[Control Panel]-[Add/Remove Programs].

Step4 Restarting

6. Connecting with Expansion Accessories

When lacking of analog output channel used to connecting external device, you have to purchase a new same module, and thus it not only increases cost but also doubles installation space. At the same time, adding channels is considered when designing this module, and additional module can be connected by the connector on module side, so that not only the cost but also the installation space are controlled.

Up to 3 modules DAI12-4(FIT)GY can be connected when adding channels.

In the case of combination of the USB module “DAI12-4(USB)GY” and three expansion modules “DAI12-4(FIT)GY”, it is possible to control 16 channels output by way of one USB port.

Table 6.1. Expansion Module

Model	Output channel	Current consumption	Function
DAI12-4(FIT)GY	4	+5VDC 400mA (Max.)	Expansion module for DAI12-4(USB)GY

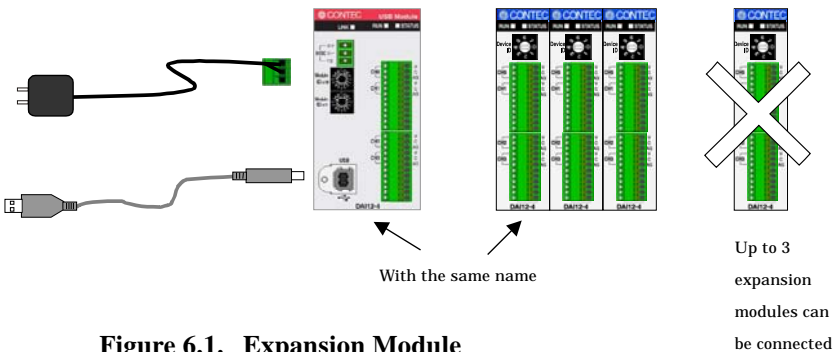

Figure 6.1. Expansion Module

Points

- Up to 3 modules can be connected.
- Please use the supplied AC adapter when adding modules.
- The analog grounds of both USB module and expansion module are isolated from each other.
- Modules with different function from the USB module can not be connected

In addition, besides the Ac adapter, the power supplies (Option) installable on DIN rail are provided.

You can choose by the environment and purpose.

Table 6.2. Power Supply

Category	Model	Input	Output	External dimensions(mm)	DIN rail
AC adapter	POA-AD22 (Bundled)	90 - 264VAC	5.0VDC \pm 5% 2.0A (Max.)	44.0(W) x 55.0(D) x 26.5(H) (exclusive of protrusions)	No
AC-DC power	POW-AD13GY	85 - 132VAC	5.0VDC \pm 5% 3.0A (Max.)	52.4(W) x 64.7(D) x 94.0(H) (exclusive of protrusions)	Yes
AC-DC power	POW-AD22GY	85 - 265VAC	5.0VDC \pm 5% 2.0A (Max.)	52.4(W) x 64.7(D) x 94.0(H) (exclusive of protrusions)	Yes
AC-DC power	POW-AD25GY	85 - 264VAC	5.0VDC \pm 5% 230VAC : 4.6A (Max.) 115VAC : 4.2A (Max.)	52.4(W) x 64.7(D) x 94.0(H) (exclusive of protrusions)	Yes
DC-DC power	POW-DD10GY	10 - 30VDC	5.0VDC \pm 5% 3.0A (Max.)	25.2(W) x 64.7(D) x 94.0(H) (exclusive of protrusions)	Yes

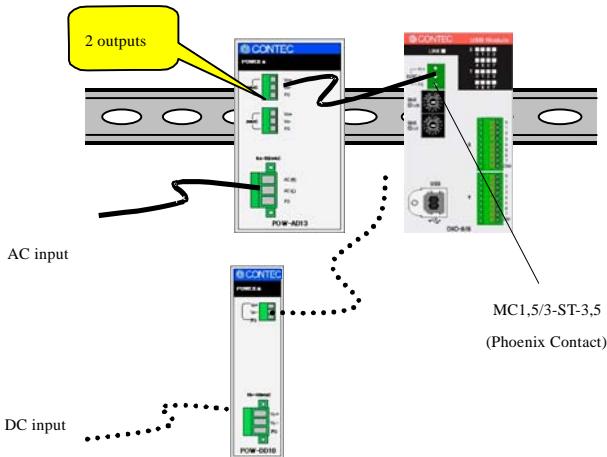

Figure 6.2. Power Supply

When using the power supply installable on DIN rail, please use the connector MC1,5/3-ST-3,5(Phoenix Contact).

Points

- If you use external power supply, please connect in the following order.
 - (1) Connect the external power connector to supply power for the USB module.
 - (2) Connect the USB module with computer using USB cable.
- You can Remove the external power supply in the following order.
 - (1) Remove USB cable.
 - (2) Remove external power connector, stop power supplying to the USB module.

Setting a Device ID

Set Device ID by rotary switch on the front when adding modules.

The ID for the first module being added must be 1 and values 2 and 3 are for the following two modules respectively. Furthermore, the factory setting for the Device ID is "0".

⚠ CAUTION _____
To avoid malfunction, please do not set the Device ID to one other than 1, 2 and 3.

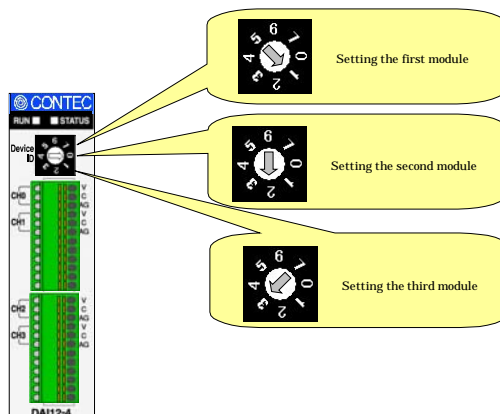

Figure 6.3. Setting a Device ID

Connection between Modules

Stack Connection Locking Devices

The module contains connecting locking devices (▲ mark, two units at the top and bottom).

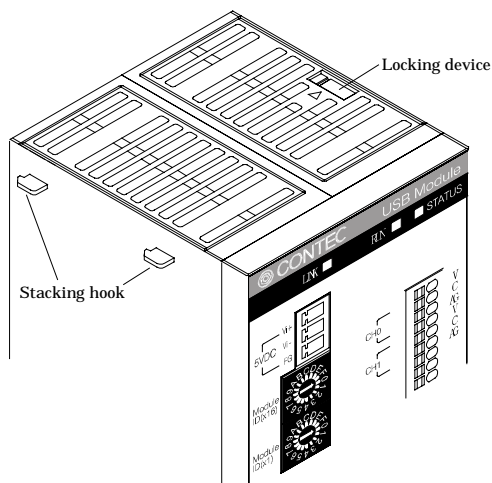
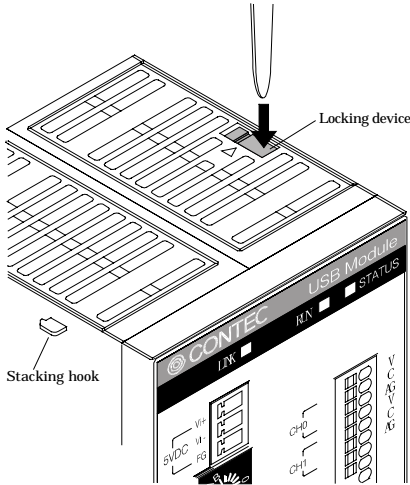

Figure 6.4. Stack Connection Locking Devices

How the Stack Connection Locking Device Works

Locking

Push the pawl of the locking device with a tool that has a slender tip downward from above to open the spring for the locking device (the groove moves toward you).



Unlocking

Push the groove of the locking device with a tool that has a slender tip in the direction of the arrow until the device is locked.

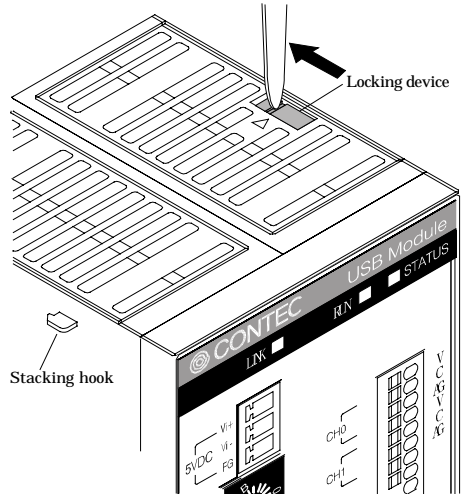

Figure 6.5. How the Stack Connection Locking Device Works

Connecting the Module

Inserting the stack hook by aligning it with the hook insertion inlet for the other device automatically locks the module. (If a stack connector protective cover is attached, the connection operation should be performed after the cover is removed.)

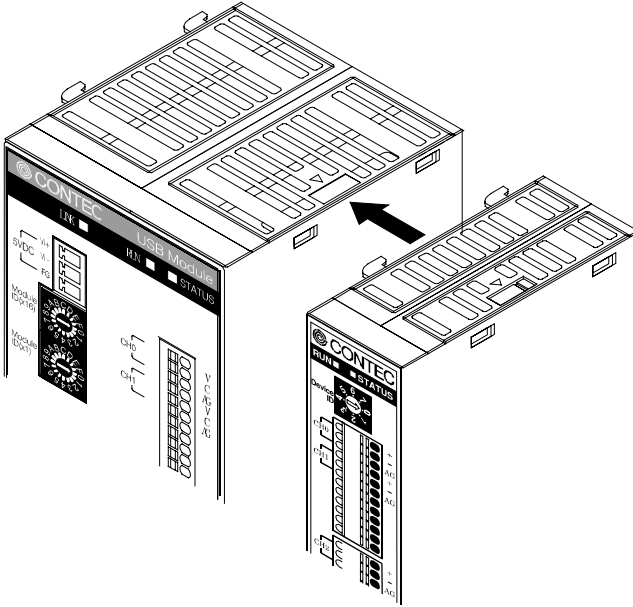

Figure 6.6. Connecting the Module

Removing the Module

Unlock the locking device at the top and the bottom. Remove the connected module from the hook.

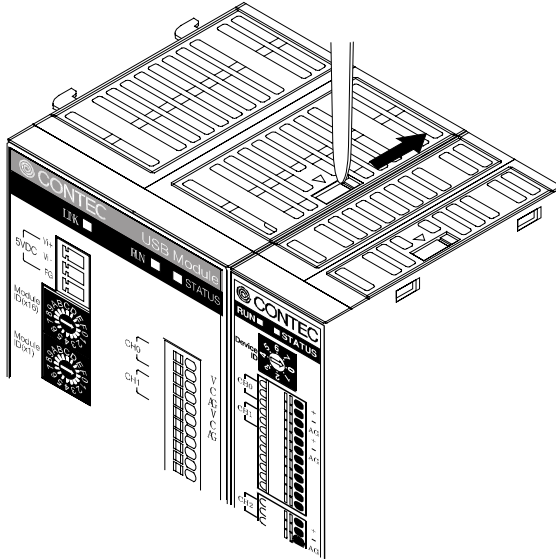

Figure 6.7. Removing the Module

7. Product Specification

Hardware Specification

Table 7.1 lists the hardware specification of DAI12-4(USB)GY.

Table 7.1. Hardware Specification < DAI12-4(USB)GY >

Item	Specification
Analog output	
Output format	Bus-isolated voltage/current output
Output range	Voltage: Bipolar $\pm 10V$, $\pm 5V$ Unipolar 0 - 10V, 0 - 5V (output current $\pm 5mA$) Current: 0 - 20mA
Output impedance	Voltage range: 10 Ω (Max.)
Output channel	4 channels
Resolution	12 bits
Conversion accuracy	Voltage range $\pm 3LSB$, Current range $\pm 5LSB$
Settling time	Voltage range 10 μ sec, Current range 20 μ sec *1
Data buffer	256K data (262, 144 data)
Internal sampling timer	10 μ sec - 1,073,741,824 μ sec *2
Communication	
USB transmission speed	12Mbps (full speed), 480Mbps (high speed) *3
Current consumption	+5VDC 700mA (Max.) *4
Others	
Number of modules used at the same time	127 modules (Max.)
Use condition	0 - 50°C 10 - 90%RH (no condensation)
External dimensions (mm)	50.4(W) x 64.7(D) x 94.0(H) (exclusive of protrusions)
Weight of the module itself	100g
Module installation method	One-touch connection to 35mm DIN rails (standard connection mechanism provided in the system)
Expansion module	DAI12-4(FIT)GY: 3 modules (Max.), Current consumption/module: +5VDC 400mA(Max.)
Connectors	FK-MC0.5/12-ST-2.5 (made by PHOENIX CONTACT) 2.5mm-pitch nominal current: 4A (Max.)
Applicable wire	AWG28 - 20 Cross-section 0.08 - 0.51mm
Bundled AC adapter(POA-AD22)	90 - 264VAC 5.0VDC $\pm 5\%$ 2.0A (Max.) Length of cable is about 1.4m

*1 Converting speed of D/A converter. The minimum executable outputting period is depending on internal processing time and is about 400msec (using one channel) - 1msec (using 16 channels).

*2 It takes the unit of 1000msec (1000msec, 2000msec, 3000msec,...) when expansion module being used.

*3 USB module executes API function by USB communication. The executing time of API function by USB communication is about several msec in practice (Depending on the contents handled by API function, it may be longer than that). The responding speed of USB module is based on the environment of the host PC being used.

*4 Always use the supplied AC adapter or power supply unit.

Software Specification

Table 7.2. Windows Drivers Specification

Item	Specification
Support OS	Microsoft Windows 98 or Second Edition Microsoft Windows Me Microsoft Windows 2000 Professional Microsoft Windows XP Professional, Home Edition
Support language	Microsoft Visual C++ Ver5.0, Ver 6.0 Microsoft Visual C++ .NET2002, 2003 Microsoft Visual Basic Ver 5.0, Ver 6.0 Microsoft Visual Basic .NET2002, 2003 Microsoft Visual C# .NET2002, 2003 Borland Delphi Ver 5.0, 6.0 Borland C++ Builder Ver 5.0, 6.0
System requirement	-PC (IBM PC/AT compatibility, DOS/V) with USB port -CD-ROM drive -Recommend the environment on which the using language can run smoothly

Circuit Block Diagram

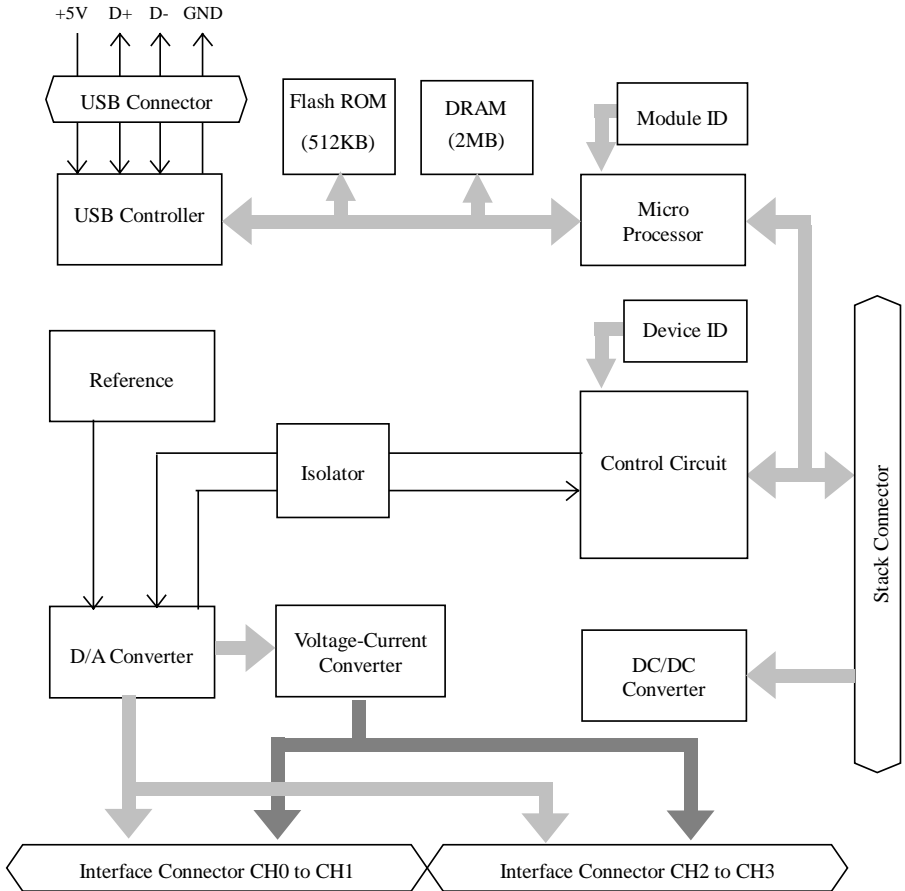

Figure 7.1. Circuit Block Diagram < DAI12-4(USB)GY >

Point

The Device ID of the USB module DAI12-4(USB)GY is fixed at "0".

Timing Chart

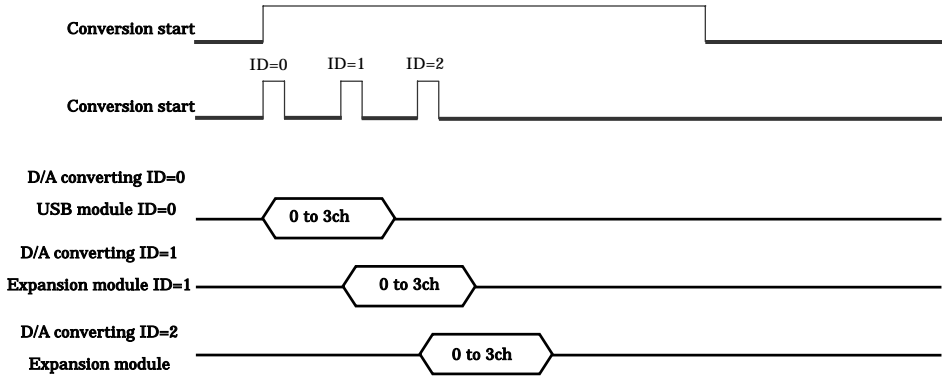

Figure 7.2. Timing Chart

Setting

Sampling timer value: 1000 μ sec

Module used: DAI12-4(USB)GY [ID=0]
 conversion channel 0ch - 3ch
 DAI12-4(FIT)GY [ID=1]
 conversion channel 0ch - 3ch
 DAI12-4(FIT)GY [ID=2]
 conversion channel 0ch - 3ch

Operation

- (1) Start timer in the conversion cycle set in DAI12-4(USB)GY.
- (2) At rise edge of internal sampling timer, output A/D conversion start command to each of DAI12-4 (USB)GY and two DAI12-4(FIT)GY.
- (3) Because DAI12-4(USB)GY and DAI12-4(FIT)GY together compose a double buffer, set conversion data in advance before performing the simultaneous conversion. Because the converting is performed at the same time, the necessary settling time is 10 μ sec for voltage output or 20 μ sec for current output per module.

External Dimensions

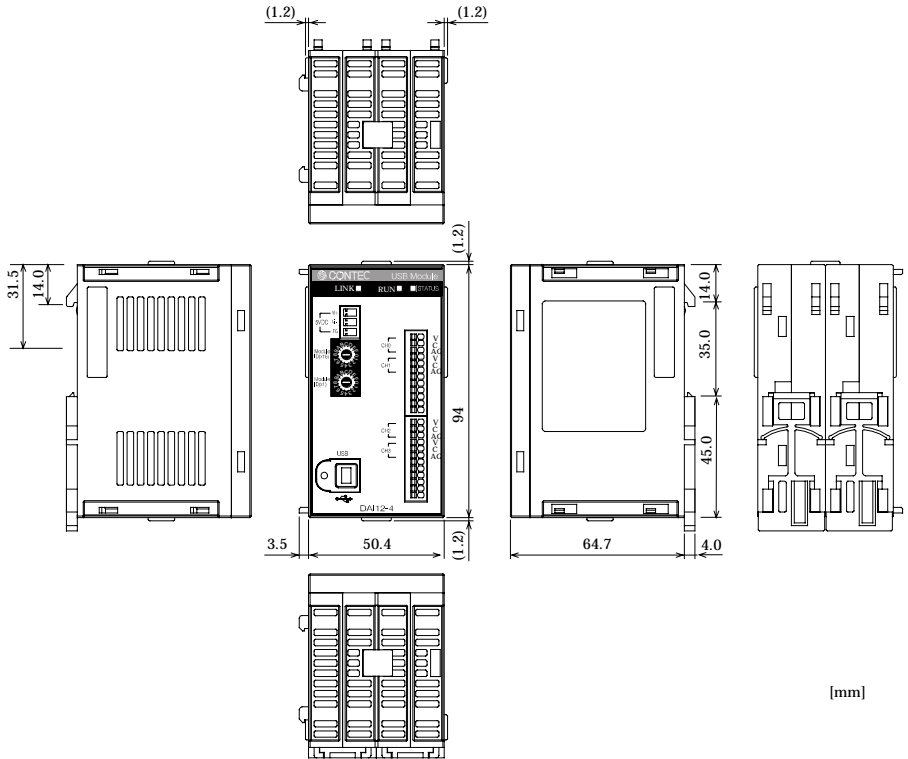

Figure 7.3. External Dimensions of the USB Module

8. Appendix

Glossary

The glossary contains a brief description of terms used in this manual.

Terms	Explanation
API [Application Program Interface]	It is abbreviation for Application Program Interface. It is the open program interface for OS corresponding to applications, and all application processing are basically performed through the API. The API provided by our company can control hardwares by calling device driver.
PDF file	It is abbreviation for Portable Document Format. It is the document format developed in order to display files not depending on specified platform. It is developed by Adobe Co.
USB [Universal Serial Bus]	It is abbreviation for Universal Serial Bus. It is not only a specification for the connection between a PC and a peripheral equipment but also a kind of terminal. It can connect a wide range of devices and can be plugged/unplugged with the power being ON (Hot Plug).
USB 2.0 [Universal Serial Bus 2.0]	The latest USB specification that keeps up the low-compatibility with previous USB and promotes the data transfer speed to 480Mbps (60MB/sec). By using USB 2.0, you can connect high-speed peripheral devices such as digital video camera, external attached storage device with high speed and broadband network device.
Device ID [Device Identifier]	It is the ID being set when connecting expansion modules and specifying connection order. It is only for expansion modules. The channel number is decided by the setting.
Self power	Supplying power by using AC adapter is called Self-Power. Please make use of AC adapter when using expansion modules.
Device driver	It is softwares to operate and set peripheral equipment by a PC, and the peripheral equipment is installed on the PC. It is simply called Driver.
Device manager	It is a Windows tool which can confirm the behavior of the peripheral equipment installed on a PC, and the state being identified by Windows and so on.
Device name	The name is set by USB driver to specify modules. It is set in Properties of Device Manager and specified in the course of API function initialization and so on.
Hardware wizard	It is support program for user without technical knowledge to add peripheral equipment to a PC. It runs automatically after the device such as USB device has been connected.
Bus power	Power is supplied by a host when USB cable is being connected without connecting a AC adapter.
Firmware	It is the software incorporated into a equipment to perform basic control on hardware. It is fixed on an equipment and does not be changed generally, it exists between hardware and software.
Properties	Select USB Modules from Device Manager, right-click and select [Properties] dialog box from pop-up menu to set the device name.
Module ID	About the ID of the USB module. Set unique ID value individually for the modules in order to distinguish the driver when using multiple modules. Use the factory setting(=0) when using one module.

DAI12-4(USB)GY

User's Guide

CONTEC CO.,LTD.

July 2005 Edition

3-9-31, Himesato, Nishiyodogawa-ku, Osaka 555-0025, Japan

Japanese <http://www.contec.co.jp/>

English <http://www.contec.com/>

Chinese <http://www.contec.com.cn/>

No part of this document may be copied or reproduced in any form by any means without prior written consent of CONTEC CO., LTD. [07142005]

[09202002]

Management No. A-46-656

[07142005_rev2]

Parts No. LYBQ481