

Industio CP-132 Series User's Manual

Industrial 2 Port RS-422/RS-485 Serial Board for PCI Bus

Dec. 1999 (1st Edition)

The content of this manual is also available at Moxa Web Site.



Moxa Technologies Co., Ltd.

Tel: +866-2-8665-6373

Fax: +886-2-8665-6372

www.moxa.com

support@moxa.com.tw

Industio CP-132 Series User's Manual

The product described in this manual is furnished under a license agreement and may be used only in accordance with the terms of the agreements.

Copyright Notice

Copyright 1999 Moxa Technologies Co., Ltd.
All rights reserved.
Reproduction in any form without permission is prohibited.

Trademarks

MOXA is a registered trademark of Moxa Technologies Co., Ltd.
All other trademarks or registered marks in this manual belong to their respective manufacturers.

Disclaimer

Information in this document is subject to change without notice and does not represent a commitment on the part of Moxa.

Moxa provides this document "as is", without warranty of any kind, either expressed or implied, including, but not limited to, the particular purpose. Moxa may make improvements and/or changes in this manual or in the product(s) and/or the program(s) described in this manual at any time.

Information provided in this manual is intended to be accurate and reliable. However, Moxa Technologies assumes no responsibility for its use, or for any infringements of rights of the fourth parties which may result from its use.

This product could include technical or typographical errors. Changes are periodically made to the information herein; these changes may be incorporated in new editions of the publication.

MOXA Internet Services

Customer's satisfaction is always our number one concern. To ensure that customers get the full benefit of our services, Moxa Internet Services have been built for technical support, product inquiry, new driver update, user's manual update, etc.

The followings are the services we provide.

E-mail for technical support

address: *support@moxa.com.tw*

FTP site for free driver update

address: *ftp.moxa.com*

or

ftp.moxa.com.tw

user ID: *ftp*

password: *your_email_address*

World Wide Web (WWW) Site for product info

address: *www.moxa.com*

or

www.moxa.com.tw

About this Manual

This manual is composed of six chapters and one appendix. This manual is written for installers, system administrators and software programmers.

If you are a first-time installer and system administrator, we recommend you to go through the whole manual except chapter 4.

If you are a software programmer, you may refer to chapter 4, “Serial Programming Tools”.

If you need cable wiring information, please see the chapter 5 “Connection Cable and Cable Wiring”.

If you encounter any problem during the installation, please refer to the chapter 6 “Troubleshooting”.

Chapter 1 Introduction

Overview and features of the Industio CP-132 Series boards, list of items and overall installation guide.

Chapter 2 Hardware Installation

Hardware installation for the Industio CP-132 Series boards and connection cable.

Chapter 3 Software Installation

Software installation, configuration, driver loading/unloading, driver update and removal for various operating systems: Windows NT, Windows 95/98 and DOS.

Chapter 4 Serial Programming Tools

Short description of the programming tools, PComm, under Windows NT and Windows 95/98 and API-232 under DOS. Also RS-485 programming issue is covered.

Chapter 5 Connection Cable and Cable Wiring

Description of the RS-422 and RS-485 cable wiring for the connection cable.

Chapter 6 Troubleshooting

Common problems and possible answers for the Industio CP-132 Series boards.

Appendix

Specification details, UART and PCI.

Table of Contents

Introduction	1-1
Overview	1-1
Features	1-3
Check List	1-4
Installation Guide.....	1-5
Hardware Installation.....	2-1
First Thing to Do: Interface Settings	2-2
Installing the Industio CP-132 Series board.....	2-3
Software Installation.....	3-1
Windows NT.....	3-1
Installing Driver.....	3-2
Configuring Board and Port.....	3-7
Updating Driver	3-9
Removing Driver	3-9
Windows 95/98.....	3-10
Installing Driver.....	3-10
Configuring Board and Port.....	3-18
Updating Driver	3-20
Removing Driver	3-22
DOS	3-23
Installing Driver.....	3-23
Driver Setup	3-24
Loading Driver.....	3-28
Unloading Driver.....	3-28
Serial Programming Tools	4-1
Windows NT and Windows 95/98.....	4-1
PComm Installation	4-1
PComm Programming Library.....	4-2
Utilities.....	4-2
DOS	4-6
Installing API-232	4-6

DOS API-232 Library.....	4-6
Utilities.....	4-6
RS-485 Programming.....	4-9
Automatic Data Direction Control Mode (Recommended).....	4-9
By RTS Mode (For back-compatibility)	4-9
Connection Cable and Cable Wiring	5-1
RS-422 Cable Wiring.....	5-1
RS-485 Cable Wiring.....	5-3
Impedance Matching and Termination Resistors.....	5-4
Troubleshooting.....	6-1
General Troubleshooting.....	6-1
Windows NT.....	6-2
Windows 95/98.....	6-3
Technical Reference.....	A-1
Specifications	A-1
PCI.....	A-2
UART 16C550C	A-2

Introduction

Overview

Industio - The Industrial Multiport Async Solution

The term **Industio** stands for smart multiport serial I/O solution for industrial applications. The **Industio CP-132 Series boards, including CP-132, CP-132I, CP-132S and CP-132IS**, are designed for 16-bit ISA/EISA bus. They offer 2 independent RS-422/RS-485 serial ports for connecting data acquisition equipment and many other serial devices to the PC and its compatible systems. It offers reliable communication link over a longer distance (4000ft). It is best suitable for industrial environment. Connections with **point-to-point full-duplex** or **multidrop half-duplex** are available to meet user's needs. Each port can control up to 32 devices in a multidrop environment.

Automatic Data Direction Control for RS-485

To ease the 2-wire RS-485 half-duplex control, an Automatic Data Direction Control (ADDC) intelligence is built on each CP-132 board, eliminating the need of software interference. Hence, the Windows applications can manage the RS-485 port without extra code to control the half-duplex protocol.

With a well-designed and fine-tuned device driver, the Industio CP-132 boards make full use of the 32 byte Tx/Rx FIFO and on-chip H/W flow control, so that they can transfer data without loss even at high speed such as 921.6 Kbps. They offer a reliable and high performance solution for serial multiport communications.

Termination Resistors Ready for RS-422/RS-485

Termination Resistors are already installed on the Industio CP-132 boards and no more headaches for finding proper resistors and connecting them for impedance matching problem. More details are in chapter, “Connection Cable and Cable Wiring”.

Surge/Isolation Protection

To prevent the boards from damage caused by lightning or high potential voltage, **TVSS** (Transient Voltage Surge Suppressor) technology is introduced in some models to protect the board. An optical isolation option (2000V) and surge protection option (ESD max. 25KV, EFT max. 2KV) is available in this series. This is critical to harsh environment such as factory.

PCI Solution

The board complies with PCI Spec. 2.1 needing neither switch nor jumper. The hardware configuration for the IRQ and I/O address is automatically assigned by the PCI BIOS. Hence, the board **MUST** be plugged first before installing the software driver. For more PCI information, please refer to Appendix “**Technical Reference**”.

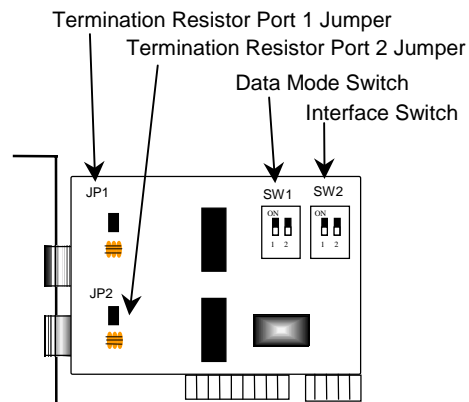

Industio CP-132 Series Board

Operating System Support

The family is operational under most major industrial platform such as Windows NT, Windows 95/98 and DOS system. **MOXA device drivers** for Windows NT, Windows 95/98 and DOS are provided for better installation, configuration and performance. In this manual, chapters for MOXA **Windows NT, Windows 95/98** and **DOS** device drivers are included.

MOXA Serial Comm Tools

For application development, MOXA provides an easy-to-use serial communication library under Windows NT, Windows 95/98 (**PCComm**) and DOS (**API-232**). Users can use this library to develop your own applications using Microsoft C, Turbo C, Assembly, QuickBASIC, Turbo Pascal, Clipper, Visual Basic, Visual C++, Borland Delphi, etc. Utilities, such as Data Scope, Monitor, Terminal Emulator, Diagnostics, etc., are included for debugging or monitoring the communication status or terminal emulation or even file transferring.

Broad Applications

The board is suitable for many industrial applications. Here are a few:

- Multipoint data acquisition
- Factory automation
- Critical industrial control
- Remote serial device control

Features

The Industio CP-132 Series consists of members as follows,

CP-132 2 RS-422/RS-485 ports, 16C550C UART

CP-132S 2 RS-422/RS-485 ports, surge protection, 16C550C UART

CP-132I 2 RS-422/RS-485 ports, isolation protection, 16C550C UART

CP-132IS 2 RS-422/RS-485 ports, surge and isolation protection, 16C550C UART

The following are the outstanding features of Industio CP-132 Series

- ❖ Support 2 independent RS-422 or RS-485 serial ports
- ❖ Compact board size (half-size)
- ❖ Switch for RS-422/RS-485 selection
- ❖ High speed up to 921.6K bps each port
- ❖ Switch for RS-485 data control – Automatic Data Direction Control Mode or By RTS Mode
- ❖ Jumper for Termination Resistors selection, no more headache for impedance matching
- ❖ Reliability—High speed 16C550C Communication Controllers with on-chip hardware flow control guarantees no data loss
- ❖ Provide surge protection for all signal lines, ESD max. 25KV, EFT max. 2KV (CP-132S, CP-132IS)
- ❖ Provide optical isolation for all signal lines, max. 2KV DC (CP-132I, CP-132IS)
- ❖ Powerful Serial Comm tools—PComm and API-232
- ❖ Support drivers for most major industrial platform—Windows NT, Windows 95/98, and DOS

CP-132 Series

Windows NT	✓
Windows 95/98	✓
DOS	✓

✓ : Driver supported by Moxa and shipped with product
Note: Download the newest drivers from the MOXA FTP service

Check List

Upon unpacking the Industio CP-132 Series package, you should find the following items:

- ❖ Industio CP-132 Series 2 port serial board × 1
- ❖ MOXA Software CD-ROM × 1, which includes:
 - Drivers for MOXA Multiport Async Products
 - **PComm Lite** programming library and utilities for Windows NT/95/98
 - API-232 programming library and utility for DOS/Windows 3.x
 - User's Manual (PDF)
- ❖ Industio CP-132 Series User's Manual (This manual)

Installation Guide

This section gives a brief summary of how to install the Industio CP-132 Series under each supported operating system. The installation is simple and involves the following stages:

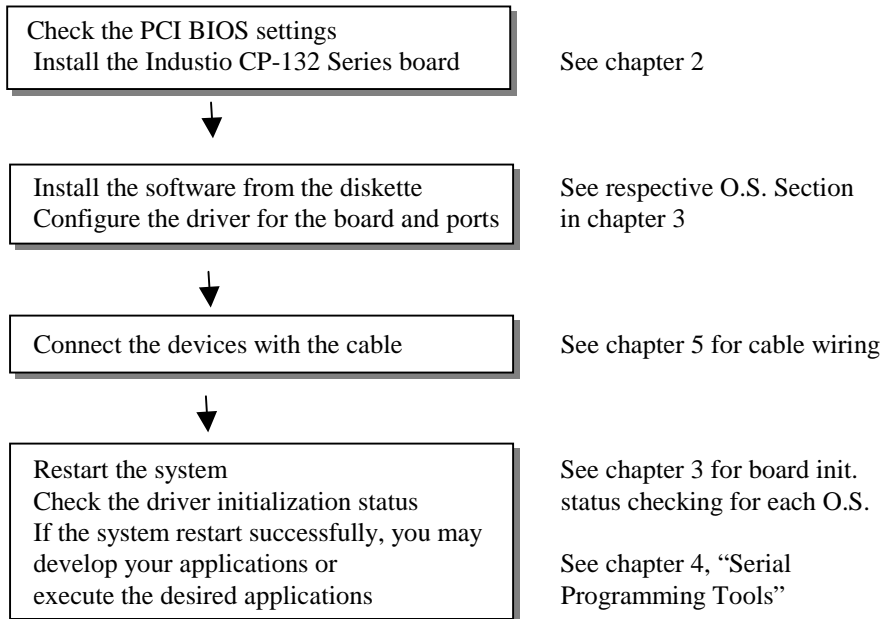

2

Hardware Installation

The installation of the Industio CP-132 Series consists of hardware and software installation. The hardware installation is detailed in this chapter. The next chapter deals with the software installation for various operating systems.

The no-switch-no-jumper Industio CP-132 Series board hardware configuration for IRQ number and I/O address is automatically assigned by the PCI BIOS. Hence, the board **MUST** be plugged first before installing the software driver.

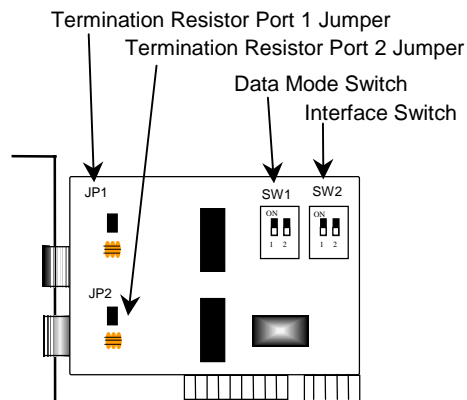

Industio CP-132 Series Board

The Industio CP-132 Series has the following default (factory) settings:

Interface Switch SW2: Port 1: **ON (RS-485)**
Port 2: **ON (RS-485)**
Data Mode Switch SW1: Port 1: **ON (Automatic Data Direction Control Mode)**
Port 2: **ON (Automatic Data Direction Control Mode)**
Termination Resistor Port 1 Jumper JP1: **Open (not used)**
Termination Resistor Port 2 Jumper JP2: **Open (not used)**

If the default settings above are what you desired and good for the system without conflicts, you may simply install the board in the system and go directly to the next chapter, “Software Installation”. Otherwise, follow the instructions below

First Thing to Do: Interface Settings

Before installing the board into the slot, you should set all the jumpers and switches to what you want.

Interface Switch SW2 for Port 1/Port 2:

ON Set the port interface to RS-485.

OFF Set the port interface to RS-422.

Data Mode Switch SW1 for Port 1/Port 2: (Valid when SW2 is set to ON)

ON Set the RS-485 port to Automatic Data Direction Control Mode.

OFF Set the RS-485 port to By RTS Mode.

Termination Resistor Port 1 Jumper JP1: (Valid when SW2 is set to ON)

Open Not using Termination Resistor

Short Using Termination Resistor

Termination Resistor Port 2 Jumper JP2: (Valid when SW2 is set to ON)

Open Not using Termination Resistor

Short Using Termination Resistor

Installing the Industio CP-132 Series board

Step 1: Power off the PC.

Warning! Make sure your system is switched off before you start installing any board. If you don't, you may risk damaging your system and the board.

Step 2: Remove the PC's cover.

Step 3: Remove the slot cover bracket if there is any.

Step 4: Plug the Industio CP-132 Series control board firmly into a free 32-bit PCI slot.

Step 5: Fasten the holding screw to fix the control board in place.

Step 6: Replace the system cover.

Step 7: Power on the PC and the BIOS will automatically set the IRQ and I/O address.

Note! Each board must occupy one unique IRQ and two 8-byte I/O addresses, which are assigned automatically by the PCI BIOS. However, you can select a free IRQ number manually via the PC's BIOS setup for the PCI slot, but normally this method is not available for the I/O address. The possible IRQ numbers are 2, 3, 4, 5, 7, 10, 11, 12, and 15. The possible I/O addresses are from 0x0000 to 0xFFFF.

Step 8: Proceed with the software installation detailed in the next chapter, "Software Installation".

3

Software Installation

In this chapter, the software driver installation, configuration and driver update/removal procedures are described for various operating systems, including Windows NT, Windows 95/98 and DOS. Before proceeding with the software installation, complete the hardware installation, detailed in previous chapter, “Hardware Installation”.

If it is necessary for you to develop your own applications, please also refer to the next chapter, “Serial Programming Tools”, for programming issues.

Windows NT

Windows NT supports up to **256** serial ports, from **COM1** to **COM256**. To fully integrate the advanced features of Windows NT, multi-process and multi-thread, pure 32-bit Windows NT device drivers are developed for the Industio CP-132 Series multiport boards. The driver conforms to Win32 COMM API standard.

- To install the driver for the first time, please go directly to the next section, “Installing Driver”.
- If you already have installed the driver and want to re-configure the board and port, add more boards or delete boards, please refer to the section “Configuring Board and Port”.
- To update or remove the driver, please go to the section, “Updating Driver” or “Removing Driver”.

Installing Driver

Following is the procedure for installing the Industio CP-132 Series driver **for the first time** under Windows NT 4.0. Make sure the board(s) has(have) already been plugged in the system PCI slot(s).

1. Please log in NT as **Administrator**.
2. Open the [**Control Panel**], click on the [**Network**] icon and select the [**Adapters**] tab.
3. Click on the [**Add**] button, then the [**Have Disk...**] button in “Select Network Adapter” dialog box.
4. Specify the exact path of the driver diskette, **A:\WINDOWS.NT**. Then click [**OK**] button.

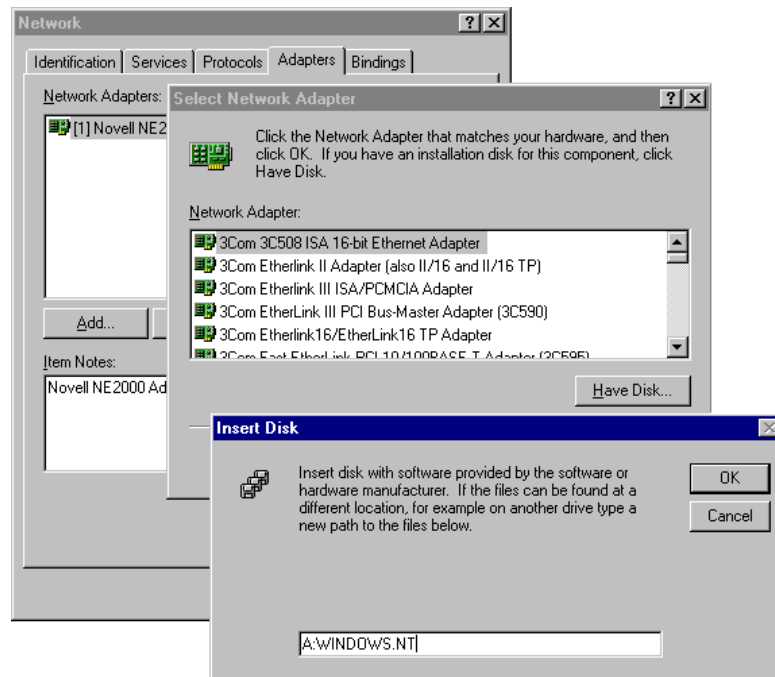

Software Installation

5. Select “**MOXA Smartio/Industio Family multiport board**” in the “Select OEM Option” dialog box, and then click [OK] to enter the “**MOXA Smartio/Industio Configuration Panel**” dialog box to start the installation.

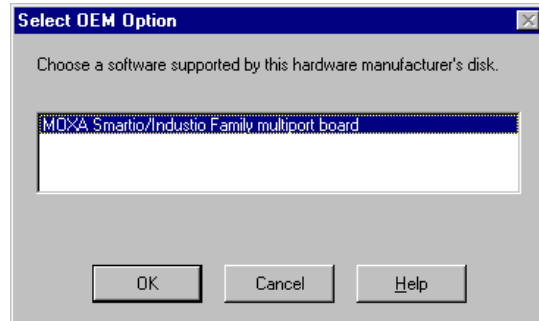

6. Click [Add] button to open **Property** dialog box to change port setting and advanced FIFO configuration done automatically by the system.



-
7. Select the newly plugged Industio CP-132 Series board from the **Board Type** pull down list.

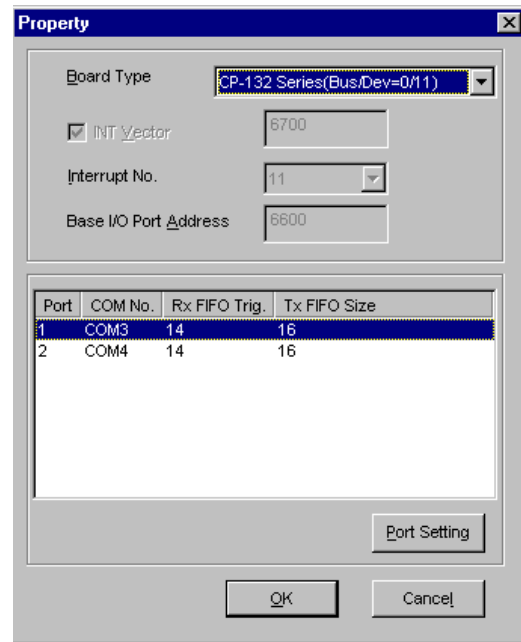

8. In the “**Property**” dialog box, select the desired port in the port list and click [**Port Setting**] to enter the individual “**Port #**” setting dialog box to change the port COM number mappings or FIFO settings.

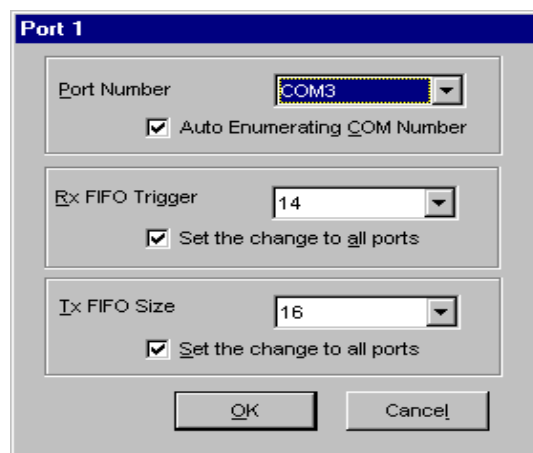

- **Port Number**

You have to set up all the ports of the board with the desired “**COM number**”, which should not conflict with other COM number in use. In this “Individual Port Setting” dialog box, you may have two ways to map the physical ports to COM numbers depending on the check box “**Auto Enumerating COM Number**”.

If “Auto Enumerating COM Number” is checked and specify the COM number of the first port, subsequent ports are mapped to continuous COM numbers. For instance, if first port is mapped to COM3, then second port is mapped to COM4 sequentially.

If “Auto Enumerating COM Number” is not checked, specify the COM number for individual port. For instance, the second port can be out of sequence, say COM10, while the first port is mapped to COM3.

- **Rx FIFO Trigger**

Rx FIFO trigger levels, at 1, 4, 8 or 14 bytes, are available, and the default value is 14 bytes.

- **Tx FIFO Size**

Tx FIFO sizes from 1 to 16 bytes are available, and the default value is 16 bytes.

9. Click **[OK]** in the “Port #” and the “Property” dialog boxes to go back to the “MOXA Smartio/Industio Configuration Panel” dialog box.

Note ! If you need to install more than one board, click [Add] and repeat steps 6 to 8 to configure another board. Up to four Industio CP-132 Series boards can be installed in a system.

Click **[OK]** to finish the configuration.

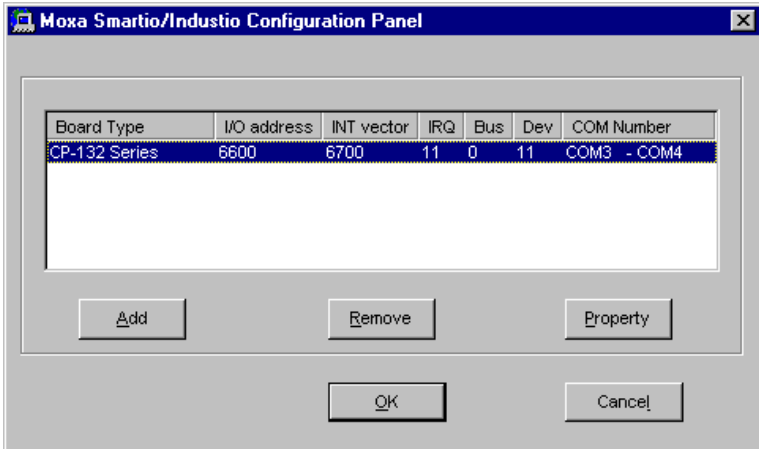

10. When configuration is done, click on **[Close]** button in the “Network Settings” dialog box.

11. Restart Windows NT system. The latest configuration will not take effect unless the system restarts.

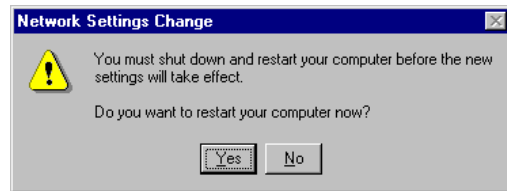

Note ! The latest configuration will not take effect unless the system restarts.

12. Once the system restarts, you may check the event log issued by the MOXA driver to see if the ports of the board are initialized successfully.

- Enter the **[Administrative]** group, click on the **[Event Viewer]** icon and select **[System Event Log]** to check a message similar to “**MOXA CP-132, with first serial port COM3, has been enabled**” for each configured board.
- If an error message similar to “**Cannot find any configured MOXA CP-132 board!**” appears, refer to the “Troubleshooting” chapter for solutions.

Note ! Once the board and the driver are installed and the driver restarts successfully, you can start to develop applications with the **PCComm** library (See “Serial Programming Tools” chapter) or the Microsoft Win32 API. You can also execute any ready-made applications, such as **PCComm** utility Terminal emulator (See “Serial Programming Tools” chapter) or HyperTerminal to transmit/receive data, as well as Remote Access Service to provide dial-up networking capabilities.

Configuring Board and Port

If you already have installed the driver and want to re-configure the ports, please follow this procedure.

1. In the [Control Panel], click on the [Network] icon and select the [Adapters] tab.
2. Select “MOXA Smartio/Industio Family Adapter” in “Network Adapters”.

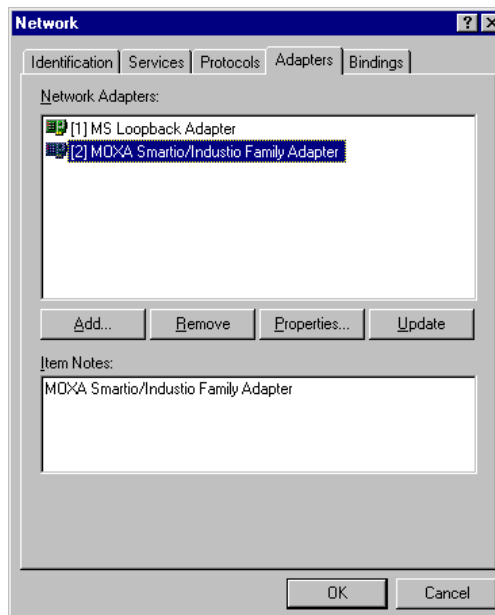

-
3. Click on the **[Properties]** button to open the “**MOXA Smartio/Industio Configuration Panel**” dialog box. Please see steps 8-9 in the previous section, “Installing Driver”, for more details.

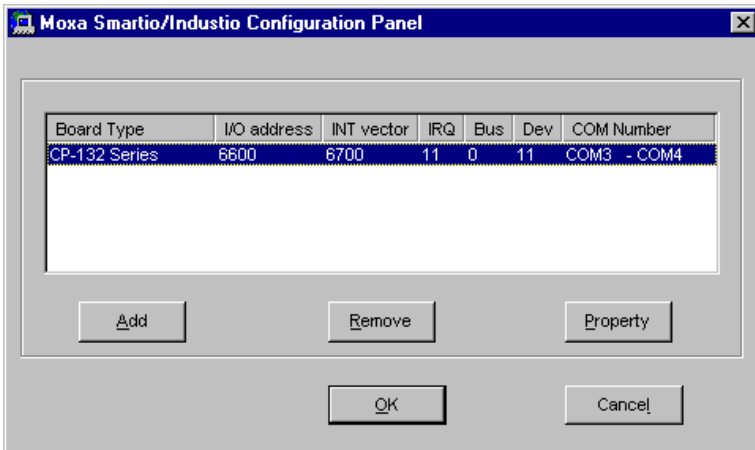

In this configuration panel, you may:

- Click **[Property]** to enter “Property” dialog box to configure the selected board with the correct “COM Number”, “Rx FIFO Trigger” and “Tx FIFO Size”. Please see **steps 8 to 9** in the previous section, “Installing Driver”, for more details.
- Click **[Add]** to add one more board that is not yet configured in the system. Please see **steps 6 to 9** in the previous section, “Installing Driver”, for more details.
- By unplugging CP-132 Series board, the system will automatically remove the configuration. Therefore, there is no need to do remove action from **Moxa Smartio/Industio Configuration Panel** dialog box.
- Click **[OK]** to confirm the configuration changes you made.
- Click **[Cancel]** to leave the dialog with the configuration unchanged.

Updating Driver

To update the driver for the Industio CP-132 Series board, simply remove the driver, as described in the next section, and reinstall it as detailed in section, “**Installing Driver**”.

Removing Driver

To remove the driver for the Industio CP-132 Series board,

1. Open the [Control Panel], click on the [Network] icon, and select the [Adapters] tab.
2. Select “**MOXA Smartio/Industio Family Adapter**” in the adapter list, then click on the [Remove] button and the [OK] button to remove the driver.
3. Restart the system to activate the new configuration.

Windows 95/98

Windows 95/98 supports up to **128** serial ports, from **COM1** to **COM128**. To fully integrate the advanced features of Windows 95/98, multi-process and multi-thread, pure 32-bit Windows 95/98 virtual device port drivers (VxD) compliant with communication drivers (VCOMM) are developed for the Industio CI-132 Series and other MOXA multiport boards. The drivers conform to the Win32 COMM API standard.

- To install the driver for the first time driver, please go directly to the section “Installing Driver”.
- If you already have installed the driver and want to re-configure the board and port, add more boards or delete boards, please refer to the section “Configuring Board and Port”.
- To upgrade or remove driver, please go to the sections, “Updating Driver” and “Removing Driver”.

Installing Driver

You can easily plug the Industio CP-132 Series board and work right away with very little installation efforts under Windows 95/98 supporting **Plug and Play** capability. Windows 95/98 will automatically detect the presence of the newly plugged board and prompt you to install the software driver for the first time. In this case, you need the driver diskette.

At most 4 Industio CP-132 Series boards can be installed in ONE system as long as the I/O addresses and IRQ number resources are sufficient and available in the system.

The following flow chart illustrates the driver installation stages of the Industio CP-132 Series boards.

Each stage will be discussed later.

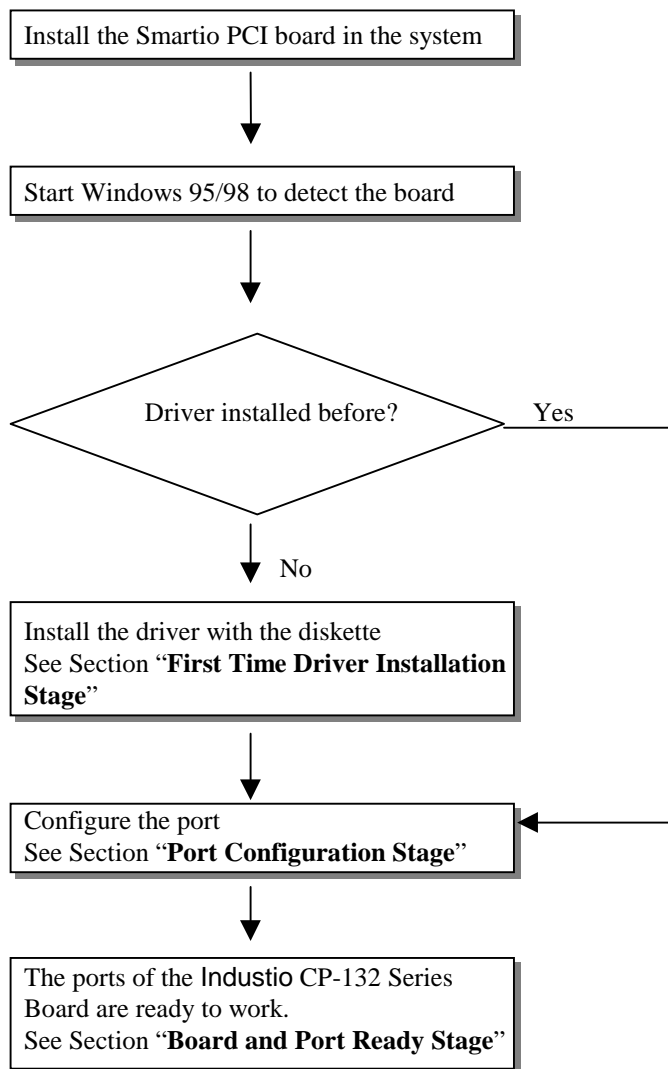

First Time Driver Installation Stage

This stage presents the steps for installing the driver for the first time of the first Industio CP-132 Series board. The installation of the Industio CP-132 Series board for Windows 95 and Windows 98 are slightly different and will be described in two columns. Follow the steps in the left column for Windows 95 or the right column for Windows 98 respectively.

If one MOXA CP-132 Series board had been previously installed and another MOXA CP-132 Series board was plugged, the system will prompt you to do **Port Configuration Stage** discussed in the next section and skips this stage.

Upon detecting the first new Industio CP-132 Series board, Windows 95/98 will automatically display a New hardware found message box, and then pop up the following dialog boxes. Click Next button.

Windows 95

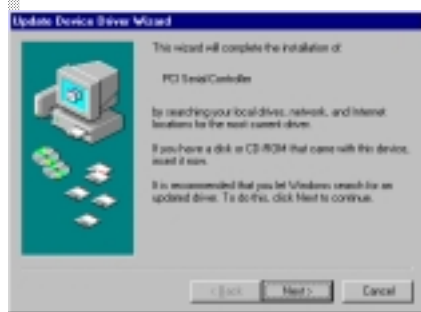

2. Click **[Other Locations]** button.

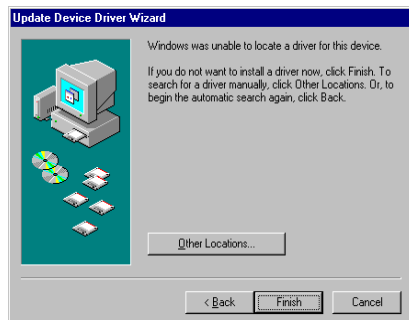

Windows 98



2. Select **[Display a list...]** and click **[Next]** button.



Software Installation

3. Type `A:\Windows.95` in the Location field, and click **[OK]** button in **Select Other Location** dialog box. The system will start reading the files from the diskette.

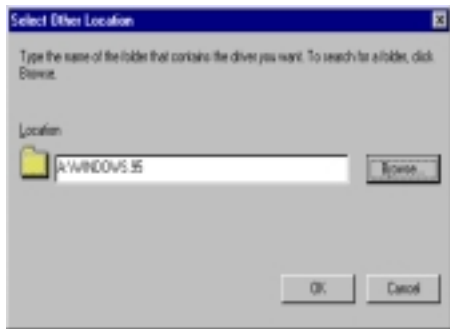

4. Click **[Finish]** button.



3. Select **Other Devices** and click **[Next]** button.

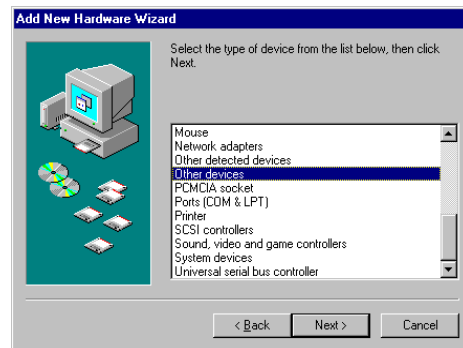

4. Click **[Have Disk]** button.

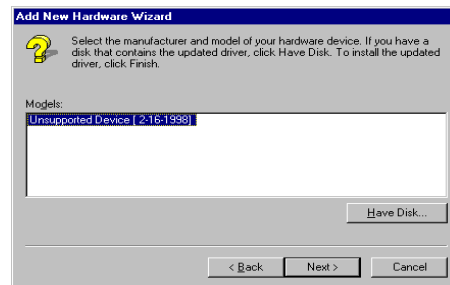

5. Type `A:\Windows.95` and click **[OK]** button. The system will start reading the files from the diskette.

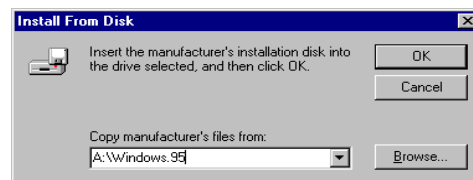

6. Click **[Next]** button.



7. Click **[Next]** button.



Port Configuration Stage

After the driver is installed, **CP-132 Series Installation** dialog box will be displayed automatically and the port mapping is automatically done by the system.

If one CP-132 Series board had installed previously and another CP-132 Series board was plugged, the system will prompt you to do port configuration directly discussed in this section.

1. Click on a specific port.
2. Click [Port Setting] button to open Port X dialog box.

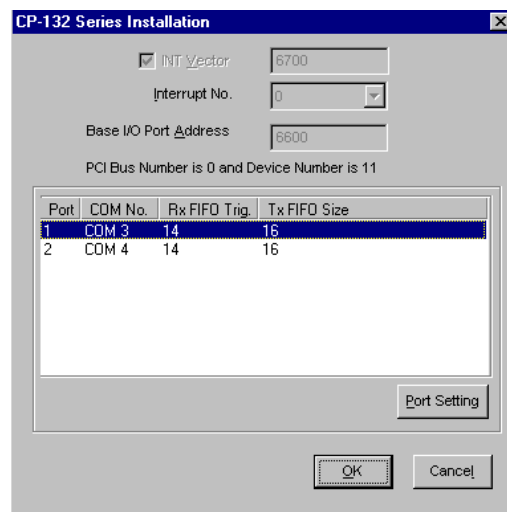

3. Select a COM number for the specific port from Port Number pull-down list.

Note! Step 4 is optional, if you want to assign COM numbers to Ports manually.

4. Check Auto Enumerating COM Number check-box then the subsequent ports are mapped to continuous COM numbers. For example, if COM 3 is assigned to Port 1, then COM 4 will be automatically assigned to Port 2.

Note! You may skip Step 5 to 8, if the system doesn't require a special performance tuning.

-
5. Select an Rx FIFO Trigger from Rx FIFO Trigger pull-down list.
Rx FIFO trigger levels, at 1, 4, 8 or 14 bytes, are available, and the default value is 14 bytes.
 6. Check Set the change to all ports check-box then if desire to apply Rx FIFO Trigger just defined to all ports.
 7. Select a Tx FIFO Size from Tx FIFO Size pull-down list.
Tx FIFO sizes from 1 to 16 bytes are available, and the default value is 16 bytes.
 8. Check Set the change to all ports check-box then the if desire to apply Tx FIFO Size just defined to all ports.



9. Click [OK] button in Port X dialog box to confirm the port setting.
10. Click [OK] button in Property dialog box to complete the port setting.

Board and Port Ready Stage

Board and Port Ready Stage for Windows 95 and Windows 98 is a slight different. In this last stage, you will complete the driver installation.

Windows 95

After the port configuration, you can immediately use the COM ports of the Industio CP-132 Series board without restarting Windows 95.

Windows 98

After the port configuration, click [**Finish**] button. The COM ports of the Industio CP-132 Series board can be used without restarting Windows 98.



Note! If an error message similar to “CP-132 Series(BusNo=x, DevNo=x, Port1=COMx) interrupt number is invalid!” pops up, refer to “Troubleshooting” chapter for solutions.

If you want to add more boards while the driver has been installed, simply plug the Industio CP-132 Series board and Windows 95/98 will automatically detect the newly plugged board and skip to **Port Configuration stage** to do port setting.

Up to now, the driver installation of the Industio CP-132 Series is complete and successful, including the board and port configuration. However, if changes of the board and port configuration are needed, please refer to the next section, “**Configuring Board and Port**”, for more configuration details.

Once the board and the driver are installed and the driver restarts successfully, you can start to develop applications with the **PComm** library (See “**Serial Programming Tools**”) or the Microsoft Win32 API. You can also execute any ready-made applications, such as **PComm** utility Terminal emulator (See “**Serial Programming Tools**”) or HyperTerminal to transmit/receive data, as well as Remote Access Service to provide dial-up networking capabilities.

Configuring Board and Port

If desire to re-configure the COM number for the ports of installed boards and drivers under Windows 95/98, please follow procedures listed below.

For this is a PCI board, once the board is added or unplugged, the configuration will be automatically added or removed by the system. Thus, it saves your effort to do add or remove action.

1. Open [Control Panel], click [System] icon, select [Device Manager] tab, and then select Moxa Smartio/Industio multiport board.
2. Click on desired CP-132 Series board entry, and click [Properties] button.

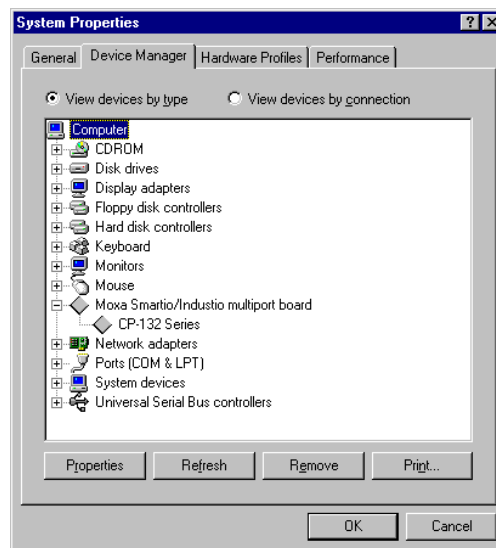

3. Select [Ports Configuration] tab.
4. Click on the specific port and click [Port Setting] button to re-assign the desired COM number for the Industio CP-132 Series port mapping.

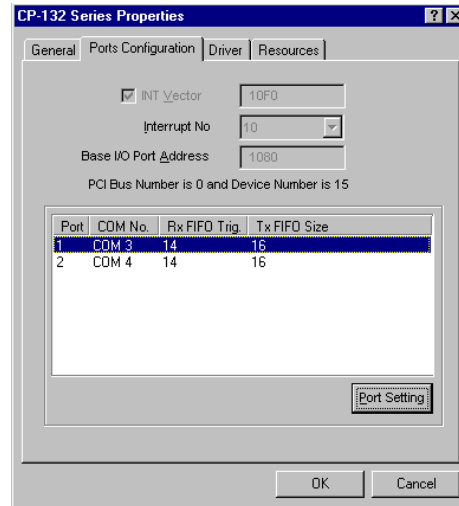

Note! Step 5 is optional, if you want to assign COM numbers to Port manually.

5. Check Auto Enumerating COM Name check-box to assign continuous COM numbers for subsequent ports. For example, if COM 3 is assigned to Port 1, then COM 4 will be automatically assigned to Port 2.

Note! Step 6 and 7 are optional, if the system doesn't require a special performance tuning.

6. Re-assign the Rx FIFO Trigger by selecting a number from the pull-down list. Check Set the change to all ports check-box if desire to apply this setting to all ports.

Rx FIFO trigger levels, at 1, 4, 8 or 14 bytes, are available, and the default value is 14 bytes.

7. Re-assign the Tx FIFO Size by selecting a number from the pull-down list. Check Set the change to all ports check-box if desire to apply this setting to all ports.

Tx FIFO sizes from 1 to 16 bytes are available, and the default value is 16 bytes.



8. Click [OK] button in Port X dialog box.
9. Click [OK] button in CP-132 Series Properties dialog box.
10. Click [OK] button in Device Manager tab.
11. Restart the system to activate the latest configuration.

Updating Driver

This section will discuss how to update the Windows 95/98 driver to enhance the function of the board.

1. Open [Control Panel], click [System] icon, and select [Device Manager] tab.

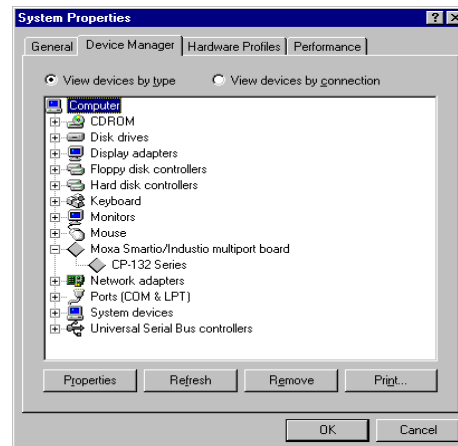

Software Installation

2. Click on MOXA CP-132 Series and click [Properties] button.
3. Select [Driver] tab.
4. Click [Update Driver...] button.



5. Click [Have Disk...] button and type the path of the new driver.
6. Insert the source diskette in the floppy drive if there is any.
7. Click [OK] button in Install from Disk dialog box.
8. The system will automatically prompt you to restart the system, click [Yes] button to restart the system. Or [No] button if you want to reboot the system later.

Removing Driver

This section explains how to remove the Industio CP-132 Series board driver.

1. Open [Control Panel] icon, double click [Add/Remove Programs] icon, and then select [Install/Uninstall] tab.
2. Click on MOXA Smartio/Industio Driver option and then click [Add/Remove] button to start the driver removal.

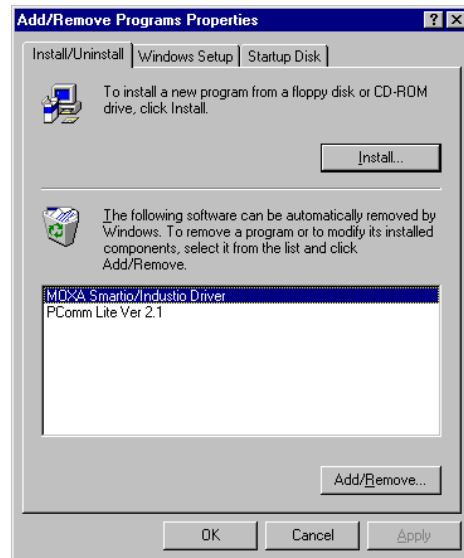

3. Click [Yes] button in the following shown message box to confirm the driver removal.

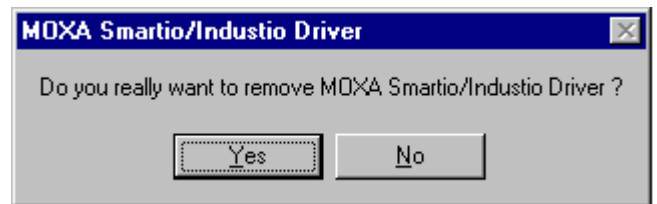

4. Click [OK] button in Add/Remove Programs Properties dialog box.

DOS

MOXA DOS API-232 is a software package that assists users to develop and/or debug programs for serial communications. This section will show you how to install the package, how to setup up the driver, and how to load or unload driver.

For details of the serial programming (API-232 Library) and utilities, please refer to the next chapter, “Serial Programming Tools”.

Installing Driver

Run the installation program, **DOSINST.EXE**, in the DOS driver diskette. Specify the target API-232 directory (e.g. **C:\MOXA**) where software driver will be copied. Press **F2** to start the installation.



After installation is complete, you will be prompted to proceed running setup program. It is strongly recommended to do so.



Driver Setup

The following are steps for setting up the Industio CP-132 Series driver. Note that it is not intended to illustrate all the convenient functions of the setup programs when configuring the boards.

1. Run the setup program, **BIN\SETUP.EXE**, in the API-232 directory.
2. Press **Enter** to pop up the SETUP dialog box. In the SETUP dialog box, select the "CP-132 Series" in the "Type" field and set up all the ports of the board with the desired "Port number", which should not conflict with other port number in use.

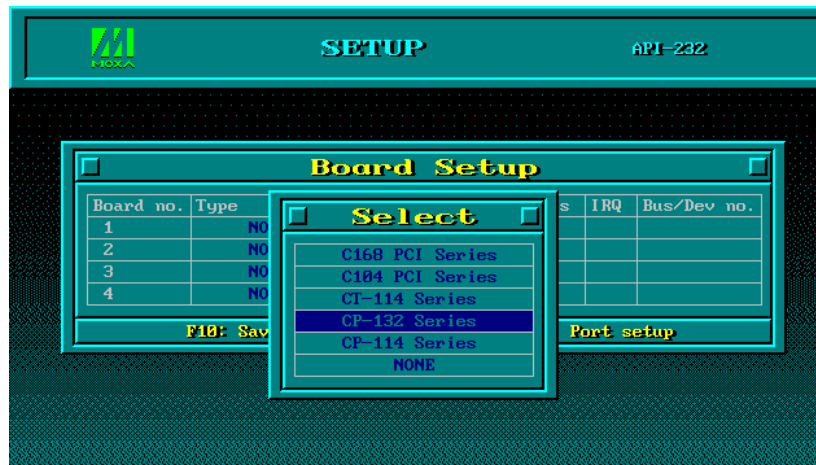
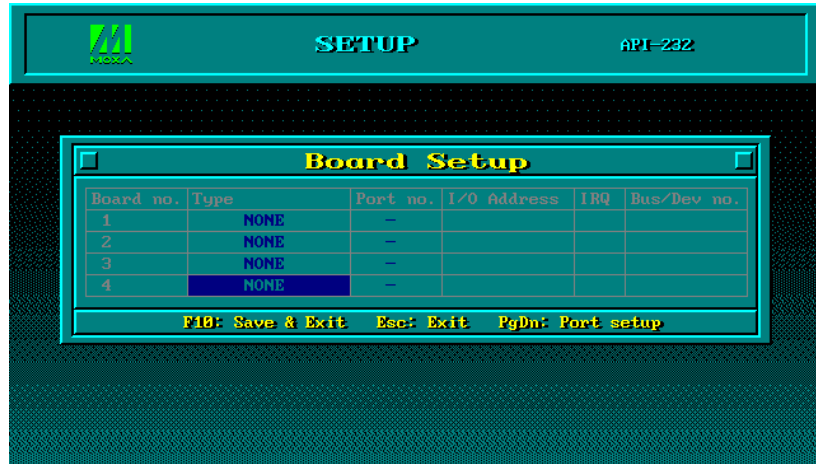

Note ! Up to now you have completed the setup for Industio CP-132 Series board. You may skip this step and go directly to the next **step 5** if you need not change any setting or configure any board.

3. You may now enter/modify each port's configuration. These displayed values are the port initial values as driver is loaded.

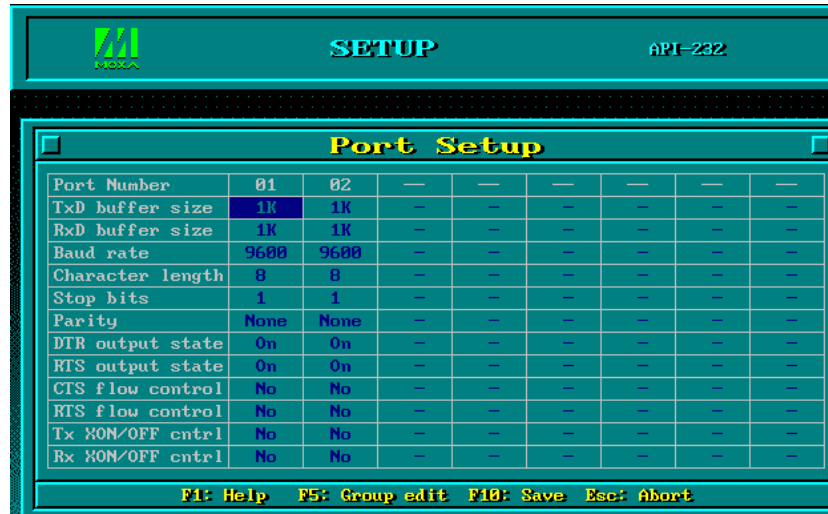

Legend: Some noticeable fields and functions are explained below.

Port number: This is actually the port ID of each port. The application software will refer to the port by its port number (ID). Duplicated port number is not allowed. That is, each MOXA serial port is referred to as port number in terms of serial programming.

You may map the port number range to the one you prefer between 0 and 255 as long as no port number overlapping condition or port number undefined condition occurs. Generally, you should take the convenience of programming into consideration when specifying the port numbers for the board.

TxD buf size: The transmit (output) buffer allocated in the system for each port.

RxD buf size: The receive (input) buffer allocated in the system for each port.

F5: Group edit: This is a convenient function that helps you edit the configuration of several ports at one time as a group.



4. To setup more boards, please follow the same instructions 2 to 3 described above.
5. Press F10 to save the latest configuration and exit the SETUP program.



Loading Driver

Having completed the setup, you can load the driver, "**BIN\DP-DRV.EXE**", at the DOS prompt. The driver will detect the Industio CP-132 Series board automatically. If the board(s) is(are) detected, a message similar to below will show:

```
Smartio/Industio Family DOS driver Version 1.1
Setup driver....
CP-132 series (Bus=0, Dev=14): O.K.!
Device driver setup O.K.
```

It means the Industio CP-132 Series driver is installed properly. At this point, you are ready to execute application that supports API-232 functions, or start developing applications using API-232 library.

If something went wrong, for instance, the board does not match the configuration or the board is missing, the screen will show a message like:

```
Smartio/Industio Family DOS driver Version 1.1
Setup driver....
CP-132 series (Bus=0, Dev=14): Board not Found.!
Setup none port !!
```

It means the Industio CP-132 Series driver is not installed properly. Please refer to chapter, "Troubleshooting", for possible reasons and solutions.

Unloading Driver

To unload (release) the Industio CP-132 Series driver from memory, type "**DP-DRV/Q**" at the DOS prompt.

4

Serial Programming Tools

Moxa supports easy but powerful serial programming library and communication troubleshooting utilities under Windows NT, Windows 95/98 and DOS. You will save a lot of developing time with the MOXA Serial Programming Tools.

The following sections will details the installation, the library and the utilities for various platforms.

Windows NT and Windows 95/98

PCComm, the professional serial comm tool for PC, is a software package under **Windows NT and Windows 95/98**, which consists of powerful serial communication library for easy programming in most popular languages, useful utilities such as diagnostic, monitor and terminal emulator, illustrative example programs and comprehensive on-line documents.

The serial communication library is useful for developing a system for data communication, remote access, data acquisition or industrial control in the Windows NT and Windows 95/98 environment, which offers an easier solution compared with the more complex Windows Win32 COMM API.

PCComm Installation

To install **PCComm**, run **\Setup.exe** from the diskette. Note that the **PCComm** diagnostic and monitor utilities are for MOXA boards only. MOXA Windows NT or Windows 95/98 device drivers, as well as MOXA boards are required. The drivers are installed separately and detailed in the “Software Installation” chapter.

PComm Programming Library

The serial communication library helps you to develop programs for serial communications **for any COM port** complying with Microsoft Win32 API. It facilitates the implementation of multi-process and multi-thread serial communication programs and hence greatly reduces developing time.

For a complete library function description and sample programs for Visual C++, Visual Basic and Delphi, please check the help file and the sample programs in the **PComm** directory.

Utilities

Following are short descriptions of each utility. For details, please see the on-line help on the diskette.

Diagnostic (for MOXA boards only)

A convenient diagnostic program that provides internal and external testing, such as IRQ, Tx/D/RxD, UART, CTS/RTS, DTR/DSR, DTR/DCD testing, etc., for the MOXA boards and ports to verify correct operations of both the software and hardware.

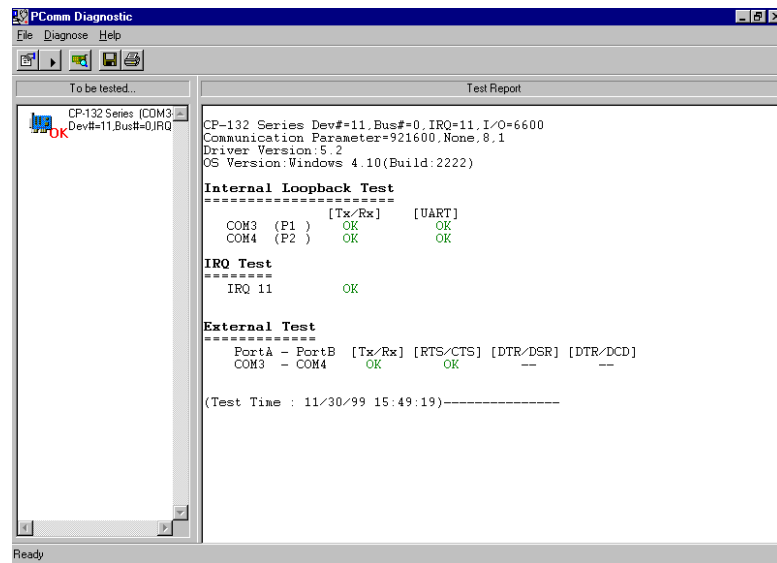

Monitor (for MOXA boards under Windows NT Only)

A useful port status monitoring program that allows you to watch the selected MOXA COM ports' data transmitting/receiving throughput and communication line status which are updated and displayed on the screen at time intervals. You can also click on one of the specific displayed port in order to visualize the current communication parameters and status of that port.

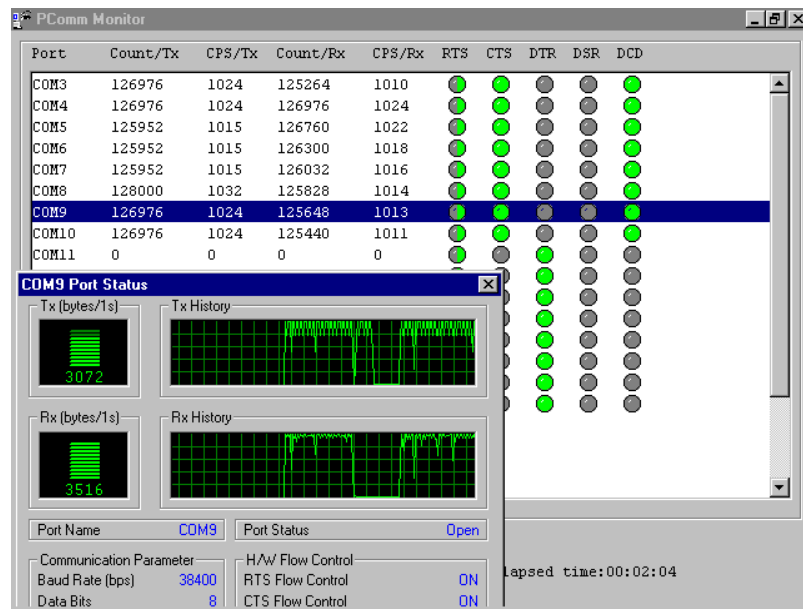

Terminal Emulator

The Terminal Emulator features multi-windows and supports terminal types of VT100 and ANSI. You can transfer data interactively, send pattern periodically or transfer file using ASCII, XMODEM, YMODEM, ZMODEM and KERMIT protocols.

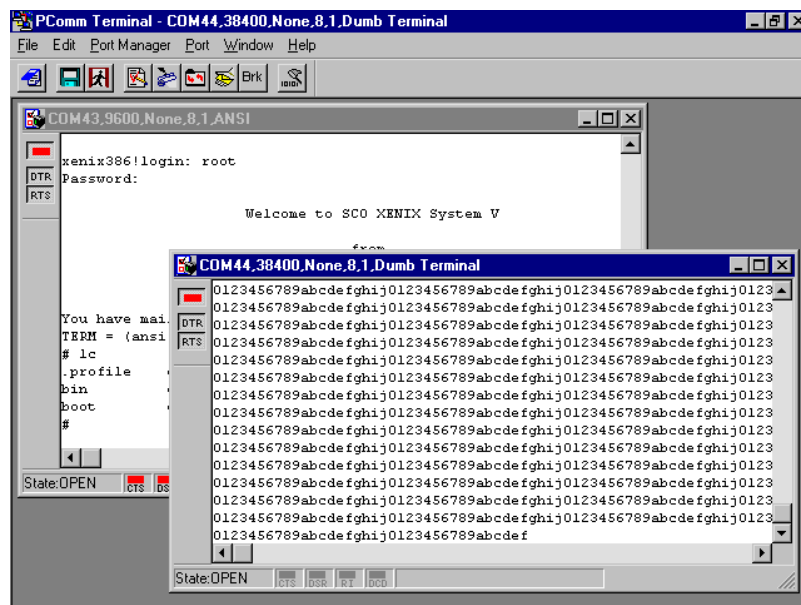

DOS

Installing API-232

API-232 Library is the professional serial programming tool for DOS. It is installed automatically along with the MOXA DOS drivers. The installation is detailed in Chapter "Software Installation".

DOS API-232 Library

DOS API-232 library supports languages like Microsoft C, Turbo C, Macro Assembly, QuickBasic, Turbo Pascal, Clipper, etc. Sample programs for each supported language are included, and placed in the sub-directory, **..\EXAMPLE\language**, of the API-232 directory.

In addition, for DOS C language only, there are also Modem Control and File Transfer library available, supporting Hayes compatible modem control as well as ASCII, KERMIT, XMODEM, YMODEM and ZMODEM file transfer protocol functions.

For complete API-232 function description, please see file **API-232.TXT** in the API-232 directory for more details.

Utilities

There are two utilities available for DOS: Data Scope and Diagnose, which are detailed below.

Data Scope

The Data Scope, **BIN\SCOPE.EXE**, is a suite of utility programs that can help users with system troubleshooting and serial communication debugging.

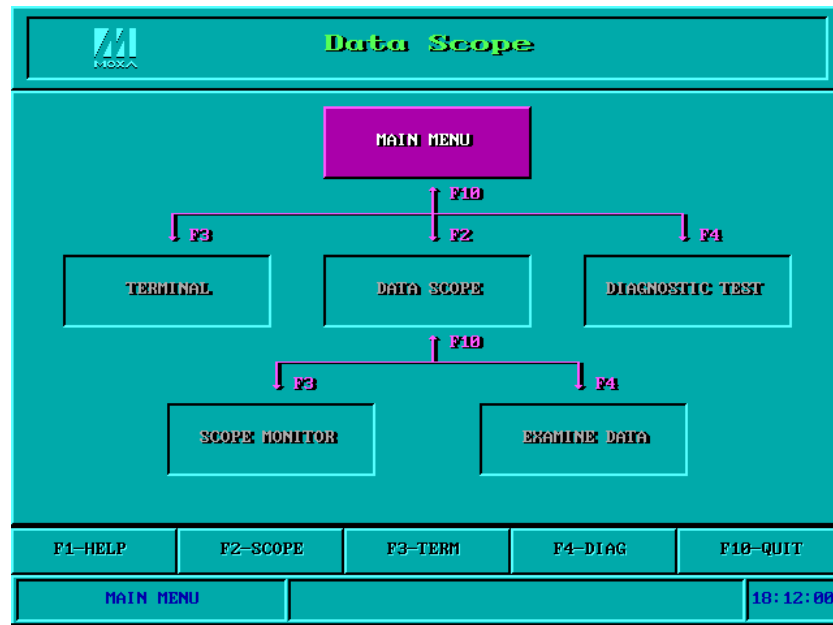

There are three major functions in Data Scope utility:

1. The **Data Scope utility** offers transparent monitoring of serial communication lines and allows data to be streamed to disk storage for later analysis.
2. The **TTY terminal emulation utility** allows user to view the signal status and transfer data interactively or files using ASCII, XMODEM, YMODEM, ZMODEM and KERMIT protocols.
3. The **Diagnostic test utility** provides port connection test with two MOXA ports connected via a properly wired cable.

Please see **on-line help** as running **BIN\SCOPE.EXE** for more usage and capability information.

Diagnose

The Diagnose, `BIN\DIAGNOSE.EXE`, is a utility that can help users to diagnose the hardware condition of each port of the selected board. See on-line help for more details.



RS-485 Programming

If you intend to do RS-485 communication with Industio CP-132 Series, please follow the RS-485 programming guide below and also refer to the chapter, “**Connection Cable and Cable Wiring**”, for more RS-485 operation details.

The Industio CP-132 Series supports **only 2-wire half-duplex RS-485 communication**. **Data+/-** pins are served for both data transmitting and receiving, depending on the mode selected: either **Automatic Data Direction Control** or **By RTS**.

Automatic Data Direction Control Mode (Recommended)

Automatic Data Direction Control scheme is the best solutions for RS-485 applications. The mode switch for the port should be set to **ON** position, to be able to use Automatic Data Direction Control Mode.

Under this mode, no extra code is required to control the data transferring (data transmitting and receiving), which is automatically managed with the intelligent hardware mechanism. That is, **RS-485 programming in this mode is just as simple as RS-232/RS-422 programming**.

By RTS Mode (For back-compatibility)

If the mode switch for the port is set to **OFF** position, By RTS Mode is used. The port is ready for transmitting data if **RTS signal is asserted** and ready for receiving data if **RTS signal is not asserted**.

RTS scheme is a traditional way and suitable for most system, including Windows NT, Windows 95/98 and DOS, or even UNIX, that permits RTS control from application programs. This mode should be compatible with most of the already-made RS-485 applications.

How to transmit and receive data for Windows NT, 95/98 & DOS

We recommend you to configure Industio CI-132 Series ports as follows in order to acquire precise timing control in RS-485 2-wire transmission.

There are 2 solutions to control RS-485 2-wire transmission.

Solution 1

The following model is common in RS-485 2-wire transmission.

```
sio_SetWriteTimeouts(port, 0); /* Set sio_write() into block mode if
                                for Windows NT and Windows 95/98
                                */
sio_RTS(port, 1);              /* Turn on RTS signal. The RS-485
                                port is ready for transmitting data. */
sio_write(port, buff, 10);     /* Write 10 byte characters in "buff".
                                The function blocks until last
                                character transmitted */
sio_RTS(port, 0);             /* Turn off RTS signal. The RS-485
                                port is ready for receiving data. */
sio_read(port, buff, 10);      /* Read 10 bytes */
```

Solution 2

There is a dedicated RS-485 function in PComm or API-232 library. It integrates the above functions of solution 1 regarding sending data as one.

```
sio_putb_x(port, buff, tick ); /* 1. Turn on RTS and ready for
                                    transmitting data.
                                    2. Send data.
                                    3. Wait for tick time.
                                    4. Turn off RTS and ready for
                                    receiving data. */
```

For more information on these functions, please refer to PComm library on-line Help file for Windows NT and Windows 95/98 or API-232.txt file for DOS, respectively.

Connection Cable and Cable Wiring

In serial data communications, the term **DTE** is for Data Terminal Equipment, like PC COM1/2, serial printers and terminals. The term **DCE** is for Data Communication Equipment, like modems.

RS-422 Cable Wiring

The RS-422 standard uses a balanced voltage digital interface to allow communications of 10M bps on cable length of 4000 feet. Ten receivers can be connected to any one driver for broadcasting systems.

RS-422 pin outs for Industrio CP-132 Series:

CP-132

1	TxD-(A)
2	TxD+(B)
3	RxD+(B)
4	RxD-(A)
5	GND
6	RTS-(A)
7	RTS+(B)
8	CTS+(B)
9	CTS-(A)

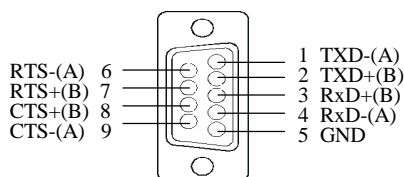

RS-422 Point-to-point

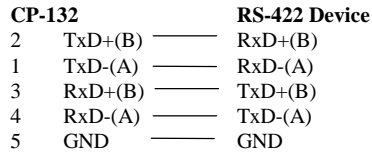

RS-422 Broadcasting

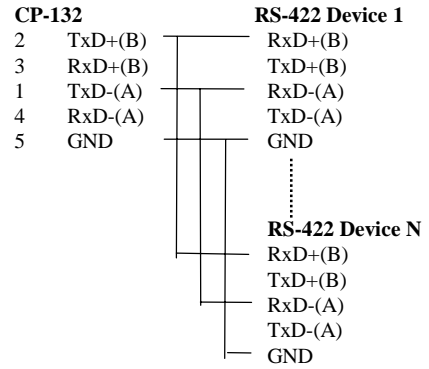

CP-132 with Handshaking

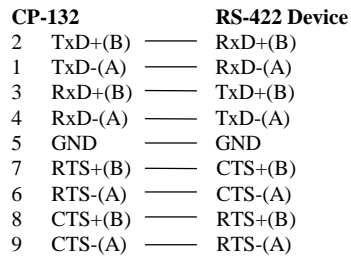

RS-485 Cable Wiring

The RS-485 standard is an enhanced version of the RS-422 balanced line standard. It allows multiple drivers and receivers in a multidrop systems. As many as 32 drivers and 32 receivers can be put on any multidrop system.

The CP-132 Series supports **only 2-wire half-duplex RS-485 communication**. **Data+/-** pins are served for both data transmitting and receiving, depending on the RTS signal.

RS-485 pin outs for CP-132:

CP-132	
1	Data-(A)
2	Data+(B)
5	GND

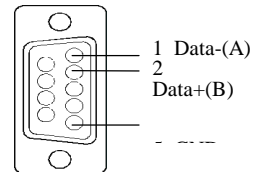

Multidrop RS-485 Half-duplex

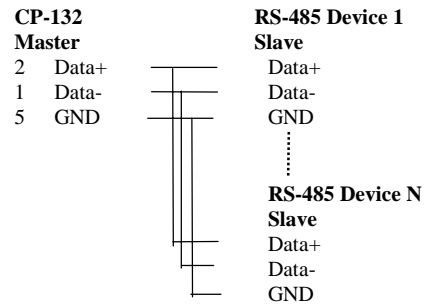

See the section “**RS-485 Programming**” of the chapter “**Serial Programming Tools**” for more RS-485 programming details.

Impedance Matching and Termination Resistors

For RS-422/485 serial communications, when an electrical signal travels through two different resistance junctions in a transmission line, the impedance mismatch will sometimes cause signal reflection. Signal reflection causes signal distortion, which in turn will contribute communication errors. The solution to this problem is to establish the same impedance at the line ends as in the line itself by terminating them with resistors.

Industio CP-132 already installs the resistors on board for your convenience, indicated as follows. The value of the termination resistor should equal the characteristic impedance of the transmission line. Resistors should be added near the receiving side.

CP-132			RS-422/485 Device
2	TxD+(B)		RxD+(B)
1	TxD-(A)		RxD-(A)
3	RxD+(B)		TxD+(B)
4	RxD-(A)		TxD-(A)
7	RTS+(B)		CTS+(B)
6	RTS-(A)		CTS-(A)
8	CTS+(B)		RTS+(B)
9	CTS-(A)		RTS-(A)

Note:  Stands for termination resistor near the receiving side

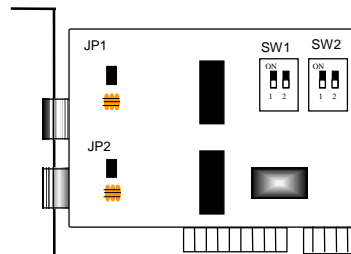

Industio CP-132 Series Board

6

Troubleshooting

Common Industio CP-132 Series problems and possible solutions are listed below. If you still have problems, contact your dealer or Moxa for help. Or use the “**Problem Report Form**” at the end of this manual to report problems to your dealer at once for faster technical support.

General Troubleshooting

1. **The MOXA PCI board cannot be detected by the MOXA driver while installing the driver.**

Hardware causes and solutions:

- a. The board is not installed or missing (absent). Please install it.
 - b. The board is not properly plugged in the system. If that is the case, re-plug the board in a 32-bit PCI slot this time. Sometimes the slot for plugging the board is malfunctioned. In this case, try other slots until you find a good one.
 - c. The motherboard does not have an available IRQ for the CP-132 Series board. Please enter BIOS and make sure there are available IRQ in PCI/PnP settings.
2. **The MOXA board and driver are activated but cannot transfer (transmitting/receiving) data.**

Hardware Causes and Solutions:

- d. Check if cable wiring is connected correctly. Please refer to the “**Connection Cable and Cable Wiring**” chapter for correct cable connection.
- e. The cable or the board are probably defective. Please try other ports, cables or boards to verify it. Or use **PComm** Diagnostic utility testing MOXA boards and port conditions. If Diagnostic reports error, replace the malfunctioned faulty components.

Software Causes and Solutions:

- f. Smartio CP-132 Series board will check the line status (CTS) before transmitting data if the RTS/CTS flow control feature is set to Enable in the configuration or application program. Please refer to the Connection Cable and Cable Wiring chapter for proper wiring and check the line status of the suspected port using the diagnostic LED indicators on the mini tester.
- g. The board controlling application might not be correctly written according to the corresponding API of the operating system. To verify the problem, please run another existing and known good application or the utilities provided by Moxa. Such as Pcomm Terminal emulator or HyperTerminal under Windows NT and Windows 95/98.

Windows NT

This section is specific for troubleshooting under Windows NT. For general problems and solutions, please see the previous section, “General Troubleshooting”.

1. **After the system reboots, the error message “Another driver in the system, which did not report its resources, has already claimed the interrupt used by xxx.” appears in the Event Log.**

This indicates the MOXA board is found, but the IRQ is conflicting with another adapter. Please check the PCI BIOS IRQ settings first and then select an IRQ that is available.

2. **After the system reboots, the error message “Cannot find any configured MOXA Smartio/Industio Series board!” appears in the Event Log.**

Please make sure the PCI board is seated firmly in the expansion slot.

3. The COM number of the Industio CP-132 Series conflicts with others.

The COM numbers of different boards happen to be the same. Try to change the COM number mappings.

4. Windows NT system panic (blue screen).

The possible reason is an IRQ or memory conflict with other ISA Bus adapters, like LAN and SCSI boards, or the system BIOS. Please refer to the corresponding problem in the previous section, "General Troubleshooting", for solutions.

Windows 95/98

This section is specific for troubleshooting under Windows 95/98. For general problems and solutions, please see the previous section, "General Troubleshooting".

1. The system fails to find the Industio CP-132 Series board!

- The board(s) is(are) not plugged properly.
 - The slot with boards plugging in is defective, please try another slot until you find a good one.
- The board might be defective.

2. After the system reboots, the error message "CP-132 Series (BusNo=x, DevNo=x, Port1=COMx) interrupt number is invalid!" appears.

This indicates that the MOXA board is found, but the IRQ is conflicting with other adapter. Make sure MOXA board's IRQ is not conflicting with other adapter's. Check the PCI BIOS IRQ settings and select an available IRQ for MOXA boards.

A

Technical Reference

Specifications

- ❖ Bus interface: 32-bit PCI
- ❖ Number of ports: 2
- ❖ Max. boards: 4
- ❖ I/O address: Assigned by PCI BIOS
- ❖ IRQ: Assigned by PCI BIOS
- ❖ Comm. controller: 16C550C or compatible
- ❖ Speed (bps): 50 ~ 921.6K
- ❖ Data bits: 5, 6, 7, 8
- ❖ Stop bits: 1, 1.5, 2
- ❖ Parity: none, even, odd, space, mark
- ❖ Data signals: RS-422 – TxD+/-, RxD+/-, RTS+/-, CTS+/-, GND
RS-485 – Data+/-, GND
- ❖ Connectors: 2×DB9 male
- ❖ Optical isolation: max. 2000V (CP-132I and CP-132IS)
- ❖ Surge protection: ESD max. 25000V, EFT max. 2000V (CP-132S and CP-132IS)
- ❖ Termination resistor: 120 Ω
- ❖ Operating temp.: 0 ~ 55 °C
- ❖ Power requirement: CP-132 – 420mA max. (+5V)
CP-132I – 700mA max. (+5V)
CP-132S – 430mA max. (+5V)
CP-132IS – 710mA max. (+5V)
- ❖ Dimensions: 120mm×80mm
- ❖ Operating Systems: See the driver support list below.

CP-132 Series

Windows NT	✓
Windows 95/98	✓
DOS	✓

✓ : Driver supported by Moxa and shipped with product
Note: MOXA FTP service is available for newest driver download

PCI

The 32-bit Industio CP-132 Series board complies with the PCI specifications 2.1. Hardware configuration for IRQ and I/O addresses is automatically assigned by the PCI BIOS. Hence, you must **first plug the board** before installing the software driver.

Unlike ISA slots, different PCI slots in the same PC may have different bus numbers and device numbers with respect to the PCI specifications. The same PCI board will have different system configurations if switching to a different PCI slot, which may be called **slot-sensitive** or **slot-dependent**. This may also apply to PCI slots in PC with different motherboard, which may use **different device number sets**. For example, some use 17, 18, 19, and 20 for identifying the respective PCI slots but some use 11, 12, 13 and 14.

Due to the **slot-dependency**, it is necessary to **re-configure the software driver** once the board is plugged in different PCI slots.

Up to 4 Industio CP-132 Series boards are allowed in one system. When installing more than one board, **please remember the order of boards** for distinguishing the installed boards.

UART 16C550C

The UART chip, **16C550C**, is an intelligent asynchronous controller capable of supporting one full duplex channel that simultaneously transfers data at **921.6 Kbps**. To increase the overall data throughput, special features such as on-chip FIFO and on-chip hardware flow control are used to reduce the number of interrupts to the onboard CPU and to prevent any loss of valuable data.

Problem Report Form

Industio CP-132 Series

Customer name:	
Company:	
Tel:	Fax:
Email:	Date:

1. **Moxa Product:** CP-132 Series **Model :** CP-132 CP-132I CP-132S CP-132IS
Serial Number: _____
2. **Moxa Driver Version:** _____
3. **Moxa hardware settings:** PCI slot number _____
 3.1 Serial Protocol: RS-422 RS-485
 3.2 RS-485 Mode: Automatic Data Direction Control Mode By RTS
4. **Operating System:** Windows 95 Windows 98
 Windows NT 3.51 Windows NT 4.0
 DOS Others
5. **PC Host:** Make _____ Model _____
6. **CPU:** Speed _____MHz Make _____ Model _____
7. **BIOS:** Make _____ Version _____
8. **PCI IRQ Configuration in BIOS:**

Slot no.	1	2	3	4
IRQ no				

9. **Problem Description:** Please describes the problem as clearly as possible, including the error message you see. We may have to follow your description to reproduce the problem.
 Board not found. Board found, but can't transfer data.
 Can transfer data, but lose data. Can transfer data, but with garbled data.
 Others. Detailed error message description is recommended:

Return Procedure

For product repair, exchange or refund, you must:

- ❖ Provide evidence of original purchase.
- ❖ Fill out the Problem Report Form (PRF) as detailed as possible for shorter product repair time.
- ❖ Obtain a Return Merchandise Authorization (RMA) number from the sales representative or dealer.
- ❖ Carefully pack the product in an anti-static package, and send it, pre-paid, to the dealer. The RMA number should be visible on the outside of the package, and include a description of the problem along with the return address and telephone number of a technical contact.